

Light takes a
new direction:
Your direction



2018

EGLO CONNECT

CONTENTS

INHALT
CONTENU

KNOW HOW

INFORMATION
SAVOIR-FAIRE

P. 002 - 009

EASY, SAFE & SMART	P. 002 - 003
GROWS & LEARNS	P. 004 - 005
INDOOR & OUTDOOR	P. 006 - 007
FUNCTION & CONTROL	P. 008 - 009

INDOOR LUMINAIRES

INNENLEUCHTEN
LUMINAIRES INTÉRIEURS

P. 010 - 041

ACCESSORIES	P. 012 - 013
LIGHTING FAMILIES	P. 014 - 019
HANGING & PENDANT LUMINAIRES	P. 020 - 021
WALL & CEILING LUMINAIRES	P. 022 - 025
SPOT & TRACK LUMINAIRES	P. 026 - 029
RECESSED & SURFACE LUMINAIRES	P. 030 - 040
LED STRIPS	P. 041

OUTDOOR LUMINAIRES

AUSSENLEUCHTEN
LUMINAIRES EXTÉRIEURS

P. 042 - 055

ILLUMINANTS

LEUCHTMITTEL
AMPOULES

P. 056 - 058

TECHNICAL DESCRIPTION

TECHNISCHE BESCHREIBUNG
DESCRIPTION TECHNIQUE

P. 059 - 080

LEGEND & REGISTER

ERKLÄRUNG & REGISTER
LÉGENDE & REGISTRE

P. 081 - 096

2



Luminaire / Bulb
Leuchte / Leuchtmittel
Luminaire / Ampoules



Remote Control / App
Fernbedienung / App
Télécommande / App

3 LET'S GO!!!



EASY, SMART & SAFE

EINFACH, INTELLIGENT & SICHER
SIMPLE, INTELLIGENT ET SÛR

If you're looking for easy installation and uncomplicated devices, EGLO connect is the right place for you.

Suchst du leichte Installationen und unkomplizierte Geräte - dann bist du bei EGLO connect genau richtig.

Des installations aisées et des appareils simples – EGLO connect est le bon dispositif pour toi.

Starting is made quick and easy, you only need two components:

Der Einstieg ist schnell und einfach, du benötigst nur zwei Komponenten:

Les premiers pas sont simples et rapides, tu as besoin de deux objets :

- › An EGLO connect luminaire / illuminant
- › An EGLO connect remote control or the free AwoX Smart control App

- › Eine EGLO connect Leuchte / Leuchtmittel
- › Eine EGLO connect Fernbedienung oder die kostenlose AwoX Smart control App

- › Une lampe / ampoule EGLO connect
- › Une télécommande EGLO connect ou l'application gratuite AwoX Smart control

You'll be set to start immediately then!

Schon kann's losgehen!

Prêt à te lancer!

The system's basic advantages are:

Die grundlegenden Vorteile des Systems sind:

Les avantages primordiaux du système sont:



Simple installation

EGLO connect products use Bluetooth technology and do not need any elaborate installations.

Einfache Installation

EGLO connect Produkte verwenden die Bluetooth Technologie und benötigen keine aufwändigen Installationen.

Une installation simple

Les produits EGLO connect emploient la technologie Bluetooth et ne nécessitent pas d'installations complexes.



Smart technology

The EGLO connect items communicate with each other to form a smart, expandable network (MESH technology).

Smarte Technologie

Die EGLO connect Artikel kommunizieren miteinander und bilden ein intelligentes, erweiterbares Netzwerk (MESH-Technologie).

Une technologie intelligente

Les articles EGLO connect communiquent les uns avec les autres et forment un réseau intelligent et extensible (technologie MESH).



Protected network

All EGLO connect products in your home form a closed network and are secured against third-party access.

Geschütztes Netzwerk

Alle EGLO connect Produkte in deinem Zuhause bilden ein geschlossenes Netzwerk und sind vor fremdem Zugriff gesichert.

Un réseau protégé

Tous les produits EGLO connect dans ton foyer forment un réseau fermé et sont ainsi protégés des accès étrangers.

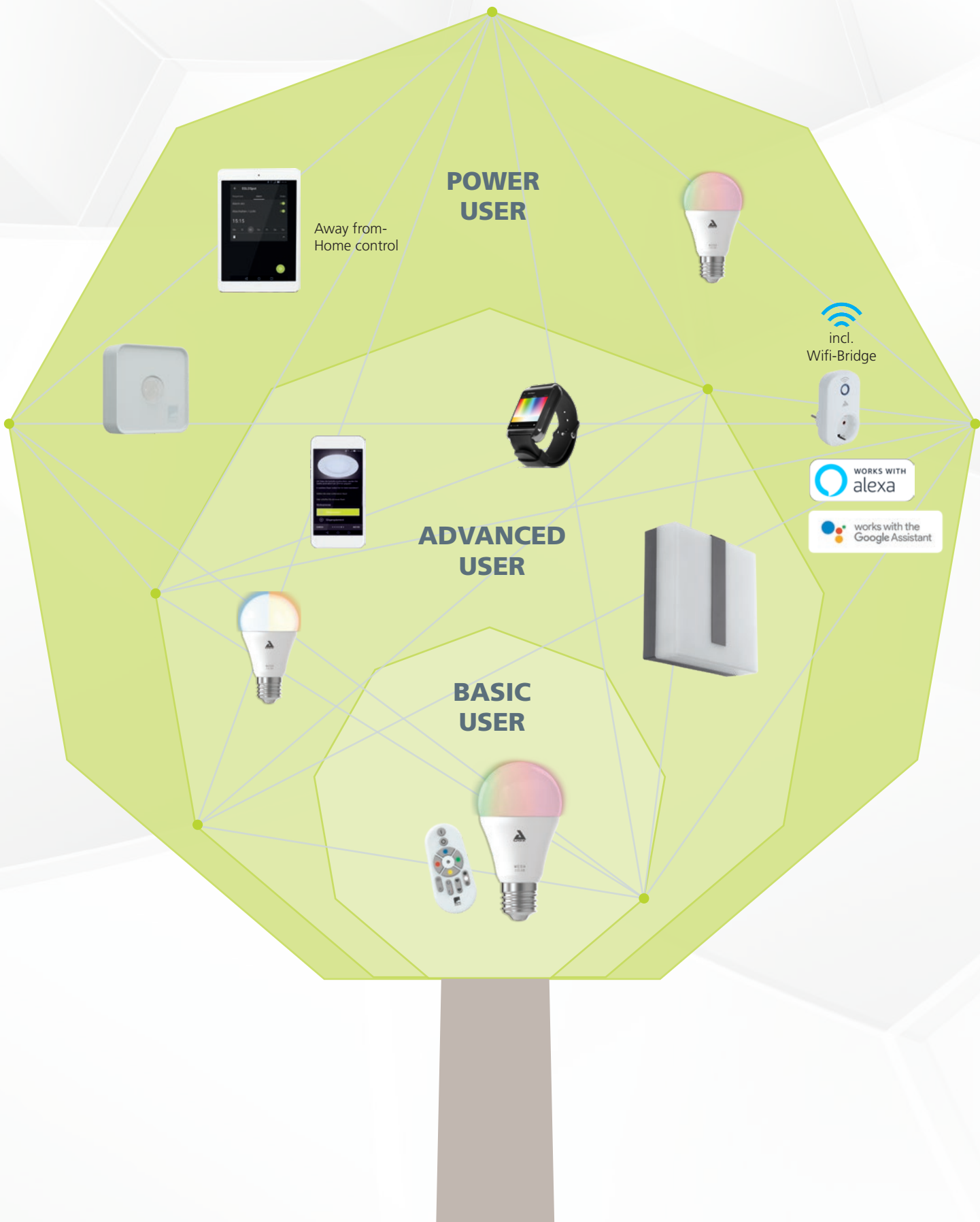

GROWS & LEARNS

WÄCHST & LERNT
APPRENDRE ET ÉVOLUER

EGLO connect grows to match your needs:

BASIC USER:

Use the EGLO connect remote control together with the EGLO connect lamps / luminaires to adjust brightness, colours and mood. These functions are practical, easy to handle and will meet your daily needs.

ADVANCED USER:

Use the App and expand your options: Combine living areas into groups to control lighting and other devices practically and quickly. Add to the experience of a movie night with the matching light scenario.

POWER USER:

Use the full potential of EGLO connect: Away from-Home control by integration in your WiFi, control by speech commands via Amazon Echo and Google Home, Day & Night function including motion detection and much more – the future of lighting in your home.

EGLO connect wächst mit deinen Bedürfnissen:

BASIC USER:

Du nutzt die EGLO connect Fernbedienung zusammen mit den EGLO connect Leuchtmitteln / Leuchten. Damit stellst du Helligkeit, Farbe und Stimmung ein. Diese Funktionen sind praktisch, einfach zu handhaben und genügen deinen täglichen Bedürfnissen.

ADVANCED USER:

Du nutzt die App und erweiterst deinen Spielraum: Fasse Wohnbereiche zu Gruppen zusammen, um Licht und andere Geräte praktisch und schnell ansteuern zu können. Verstärke das Erlebnis eines Filmabends mit dem passenden Lichtszenario.

POWER USER:

Du nutzt das volle Potential von EGLO connect. Away from-Home control durch Intergration in dein W-Lan, Steuerung per Sprachbefehl mit Hilfe von Amazon Echo und Google Home, Day & Night Funktion inklusive Bewegungserkennung und vieles mehr – Lichtzukunft in deinem Heim.

EGLO connect évolue avec tes besoins:

UTILISATEUR DE BASE:

Tu utilises la télécommande EGLO connect conjointement avec les ampoules/luminaires EGLO connect. Tu régles ainsi la luminosité, la couleur et l'ambiance. Ces fonctions sont pratiques, faciles à manier et suffisent à tes besoins au quotidien.

UTILISATEUR AVANCÉ:

Tu utilises l'application et accrois ta marge de manoeuvre : tu rassembles des zones d'habitat en des groupes afin de pouvoir commander la lumière et les autres appareils de manière rapide et pratique. Renforces l'ambiance d'une soirée film par la scénérie lumineuse correspondante.

UTILISATEUR PUISSANT:

Tu utilises l'ensemble du potentiel d'EGLO connect. Un contrôle hors de chez toi par l'intégration dans ton Wi-Fi, un pilotage par commande vocale avec Amazon Echo et Google Home, une fonction jour & nuit avec détection de mouvements et bien d'autres choses - l'avenir de l'éclairage dans ta maison.



6



INDOOR & OUTDOOR

INNEN & AUSSEN
INTÉRIEUR ET EXTÉRIEUR

EGLO connect can be used with indoor as well as outdoor lighting fixtures.

Control your light anywhere and anytime, and enjoy the advantages of smart lighting. Use the EGLO connect sensor to increase safety around your home. Brightness and movement activate the light and will deter unwelcome guests. Never grope for a light switch again and keep your hands free to carry your purchases home.

Our EGLO connect outdoor lamps withstand any weather condition. These offer an attractive complimentary package, together with our indoor lamps.

EGLO connect ist für den Innen- und Außenbereich geeignet.

Steuere dein Licht jederzeit und überall und genieße die Vorteile smarter Beleuchtung. Mit dem EGLO connect Sensor erhöhst du die Sicherheit rund um dein Zuhause. Sowohl Helligkeit als auch Bewegung aktivieren das Licht und schrecken ungebetene Gäste ab. Du musst nie wieder nach einem Lichtschalter tasten und hast die Hände frei, um Einkäufe nach Hause zu bringen.

Unsere EGLO connect Außenleuchten halten jeder Witterung stand und bilden zusammen mit unseren Innenleuchten ein attraktives Gesamtpaket.

EGLO connect convient pour une utilisation à l'intérieur et à l'extérieur.

Contrôle ta lumière à tout moment et de partout et prends plaisir aux avantages d'un éclairage intelligent. Avec le capteur EGLO connect, tu augmentes la sécurité autour de ta maison. Aussi bien la luminosité que des mouvements actionnent la lumière et découragent les visiteurs non souhaités. Tu n'as plus jamais à rechercher un interrupteur et tu as les mains libres pour rentrer les courses chez toi.

Nos luminaires extérieurs EGLO connect résistent à toute intempérie et forment communément avec tes luminaires intérieurs un ensemble attrayant.



FUNCTION & CONTROL

FUNKTION & BEDIENUNG FONCTION ET COMMANDE



Basic functions / Grundfunktionen / Fonctions de base

Activation / deactivation Ein- / Ausschalten Allumer / éteindre		•	•	•	•
Motion sensor Bewegungssensor Capteur de mouvements	•				
Light colour regulation Lichtfarben regulieren Réguler les teintes lumineuses		16,7 Mio.	16,7 Mio.		16,7 Mio.
Smooth dimming* Stufenloses Dimmen* Graduation continue*		•	•		•
Voice control Sprachsteuerung Commande par la voix					•

Comfort functions / Komfortfunktionen / Fonctions confort

Pre-set scenarios Voreingestellte Szenarien Scéneries prédéfinies			•		
Saving favourites Favoriten speichern Sauvegarder les favoris		2	4		
Grouping lamps Leuchten gruppieren Regroupement des luminaires			•		
Programming function (on / off) Programmierfunktion (Ein / Aus) Fonction de programmation (marche / arrêt)			•	•	•
Dawn simulation Dämmerungssimulation Simulation de crépuscule			•		
Timer function Timer-Funktion Fonction de minuterie			•	•	•
Day & night function Tag & Nacht-Funktion Fonction jour & nuit	•				
Night light Nachtlicht Veilleuse de nuit			•		
Names & pictures for luminaires Namen & Bilder für Leuchten Noms et photos pour les luminaires			•		
Disco function Diskofunktion Fonction disco			•		
BLE Smart Meter function BLE Smart Meter Funktion BLE Fonction smart meter				•	•

* for EGLO connect luminaires / bulbs only - nur für EGLO connect Leuchten / Leuchtmittel - seulement pour luminaires / ampoules EGLO connect

INDOOR

INNENLEUCHTEN
LUMINAIRES INTÉRIEURS





CONNECT REMOTE
12



PLUG
12



PLUG PLUS
12



FRAIOLI-C
14



FRAIOLI-C
14



FRAIOLI-C
14



FRAIOLI-C
15



FRAIOLI-C
15



FRATTINA-C
16



FRATTINA-C
16



FRATTINA-C
16



FRATTINA-C
16



RIODEVA-C
18



RIODEVA-C
18



MONEVA-C
20



MONEVA-C
20



COMBA-C
20



CAPASSO-C
22



BERAMO-C
22



CAPASSO-C
22



GIRON-C
23



VOLTAGO-C
23



COMPETA-C
23



TOTARI-C
24



TOTARI-C
25



TOTARI-C
25



CORROPOLI-C
26



CORROPOLI-C
26



CORROPOLI-C
26



CORROPOLI-C
27



PALOMBARE-C
28



PALOMBARE-C
28



PALOMBARE-C
28



PALOMBARE-C
29



FUEVA-C
30



FUEVA-C
30



FUEVA-C
31



FUEVA-C
31



FUEVA-C
32



FUEVA-C
32



FUEVA-C
32



FUEVA-C
33



FUEVA-C
34



FUEVA-C
34



FUEVA-C
35



FUEVA-C
35



FUEVA-C
36



FUEVA-C
36



FUEVA-C
37



FUEVA-C
37



SALOBRENA-C
38



SALOBRENA-C
38



SALOBRENA-C
38



SALOBRENA-C
39



SARSINA-C
40



SARSINA-C
40



SARSINA-C
40



STRIPE-C
41



STRIPE-C
41



32732 CONNECT REMOTE

L 110, B 53, H 20

remote control; plastic, white
Fernbedienung; Kunststoff, weiss
télécommande; plastique, blanc



97476 PLUG

L 62, H 110, A 35

plug; plastic, white
Stecker; Kunststoff, weiss
connecteur; plastique, blanc

PLUG PLUS & PLUG

The intelligent connector that checks your consumption and turns all your devices into smart objects. Now you can control your home with the touch of a finger.

FEATURES PLUG PLUS & PLUG

- › **ON / OFF** - with AwoX Smart Control / remote control
- › **BLE Power Meter**
- › **Power rating** - 10A / max. 2300W / 230 V AC
- › **Control distance** - up to 15 m
- › **Connectivity** - Bluetooth® Smart Mesh
- › **Version** - GE (Shuko CEE 7/7)

ADDITIONAL FEATURES PLUG PLUS

› **Local and external control:** Local control via Bluetooth® Mesh-Technology and Away-from-home-control via AwoX Cloudservice › **Voice Control:** Amazon Alexa supported / Google Home ready › **Connectivity:** Wi-Fi Bridge with Bluetooth® Mesh ecosystem.

Der kluge Stecker, der deinen Stromverbrauch kontrolliert. Verwandle alle deine Geräte in smarte Objekte. Jetzt kannst du dein ganzes Haus mit der Berührung eines Fingers bedienen.

FUNKTIONEN PLUG PLUS & PLUG

- › **ON / OFF** - mit AwoX Smart Control App / Fernbedienung
- › **BLE Energiemesser**
- › **Power rating** - 10A / max. 2300W / 230 V
- › **Bedienschweite** - bis zu 15 m
- › **Connectivity** - Bluetooth® Smart Mesh
- › **Version** - GE (Schuko CEE 7/7)

ZUSÄTZLICHE FUNKTIONEN PLUG PLUS

› **Lokale Steuerung und externe Fernsteuerung:** Lokale Steuerung mittels Bluetooth® Mesh-Technologie und Away-from-home-Steuerung mittels AwoX Cloudservice › **Sprachsteuerung:** Unterstützung von Amazon Alexa / Google Home ready › **Verbindung:** Wi-Fi Bridge mit Bluetooth® Mesh ecosystem.

La prise programmable qui mesure ta consommation d'électricité. Transforme tous tes appareils en objets connectés. Maintenant tu peux contrôler toute ta maison en un clic.

FUNCTIONS PLUG PLUS & PLUG

- › **MARCHE / ARRÊT (ON / OFF)** - avec commande intelligente AwoX (AwoX Smart Control application) / télécommande
- › **Compteur d'énergie BLE**
- › **Puissance nominale** - 10 A / max. 2300 W / 230 V
- › **Portée de commande** - jusqu'à 15 m
- › **Connectivité** - Maillage intelligente Bluetooth® (Bluetooth® Smart Mesh)
- › **Version** - GE (Shuko CEE 7/7)

FUNCTIONS SUPPLÉMENTAIRES PLUG PLUS

› **Commande locale et commande à distance externe:** Commande locale à l'aide de la technologie de maillage Bluetooth® (Bluetooth® Mesh-Technologie) et commande à distance à l'aide de service en nuage AwoX (AwoX Cloudservice) › **Contrôle vocal:** Soutenu par Amazon Alexa / Google prêt à la maison (Google Home ready) › **Connexion:** Pont Wi-Fi (Wi-Fi Bridge) avec maillage écosystème Bluetooth® (Bluetooth® Mesh ecosystem).



incl.
Wifi-Bridge



97936 PLUG PLUS

L 62, H 110, A 35

plug; plastic, white
Stecker; Kunststoff, weiss
connecteur; plastique, blanc



incl.
Wifi-Bridge





97907 FRAIOLI-C

L 1055, B 100, H 1200

Socket:	LED
Power:	2x 17 W
Lumen:	4600 lm

pendant luminaire; aluminium, satin nickel / plastic, white

Hängeleuchte; Alu, nickel-matt / Kunststoff, weiss

luminaire en suspension; aluminium, nickel mat / plastique, blanc



97908 FRAIOLI-C

H 1755, Base: B 280, T 280

Socket:	LED
Power:	2x 17 W
Lumen:	4600 lm

floor luminaire; aluminium, satin nickel / plastic, white

Stehleuchte; Alu, nickel-matt / Kunststoff, weiss

lampadaire; aluminium, nickel mat / plastique, blanc



97906 FRAIOLI-C

L 1055, B 120, H 65

Socket:	LED
Power:	2x 17 W
Lumen:	4600 lm

ceiling luminaire; aluminium, satin nickel / plastic, white

Deckenleuchte; Alu, nickel-matt / Kunststoff, weiss

plafonnier; aluminium, nickel mat / plastique, blanc





97911 FRAIOLI-C

L 1050, B 100, H 1200

Socket:	LED
Power:	2x 17W
Lumen:	4600 lm

pendant luminaire; aluminium, satin nickel / plastic, white
Hängeleuchte; Alu, nickel-matt / Kunststoff, weiss
luminaire en suspension; aluminium, nickel mat / plastique, blanc



97909 FRAIOLI-C

L 1050, B 120, H 125

Socket:	LED
Power:	2x 17W
Lumen:	4600 lm

ceiling luminaire; aluminium, satin nickel / plastic, white
Deckenleuchte; Alu, nickel-matt / Kunststoff, weiss
plafonnier; aluminium, nickel mat / plastique, blanc





97811 FRATTINA-C

H 130, Ø 435

Socket:	LED
Power:	27W
Lumen:	3400lm

ceiling luminaire; steel, satin nickel / plastic, white
Deckenleuchte; Stahl, nickel-matt / Kunststoff, weiss
plafonnier; acier, nickel mat / plastique, blanc



97812 FRATTINA-C

H 1500, Ø 435

Socket:	LED
Power:	27W
Lumen:	3400lm

pendant luminaire; steel, satin nickel / plastic, white
Hängeleuchte; Stahl, nickel-matt / Kunststoff, weiss
luminaire en suspension; acier, nickel mat / plastique, blanc



97813 FRATTINA-C

H 115, Ø 290, Base: Ø 200

Socket:	LED
Power:	18W
Lumen:	2300lm

table luminaire; steel, satin nickel / plastic, white
Tischleuchte; Stahl, nickel-matt / Kunststoff, weiss
luminaire de table; acier, nickel mat / plastique, blanc



97814 FRATTINA-C

H 1815, Ø 290, Base: Ø 300

Socket:	LED
Power:	18W
Lumen:	2300lm

floor luminaire; steel, satin nickel / plastic, white
Stehleuchte; Stahl, nickel-matt / Kunststoff, weiss
lampadaire; acier, nickel mat / plastique, blanc





97812

97814

17



96996 RIODEVA-C

H 105, Ø 445

Socket:	LED
Power:	27 W
Lumen:	3400 lm

ceiling luminaire; steel, black / plastic, white

Deckenleuchte; Stahl, schwarz / Kunststoff, weiss

plafonnier; acier, noir / plastique, blanc



96997 RIODEVA-C

H 1500, Ø 445

Socket:	LED
Power:	27 W
Lumen:	3400 lm

pendant luminaire; steel, black / plastic, white

Hängeleuchte; Stahl, schwarz / Kunststoff, weiss

luminaire en suspension; acier, noir / plastique, blanc



smooth dimming via remote control or app / stufenlos dimmbar über Fernbedienung oder App / Graduation continue par télécommande ou l'application



96997

19

96979 MONEVA-C

H 1500, Ø 485

Socket:	LED
Power:	27 W
Lumen:	3400 lm

pendant luminaire; steel, black / plastic, white
Hängeleuchte; Stahl, schwarz / Kunststoff, weiss
luminaire en suspension; acier, noir / plastique, blanc



97087 COMBA-C

H 1500, Ø 290

Socket:	LED
Power:	18 W
Lumen:	2300 lm

pendant luminaire; steel, white, copper / plastic, white
Hängeleuchte; Stahl, weiss, kupfer / Kunststoff, weiss
luminaire en suspension; acier, blanc, cuivre / plastique, blanc



96978 MONEVA-C

H 1500, Ø 405

Socket:	LED
Power:	18 W
Lumen:	2300 lm

pendant luminaire; steel, black / plastic, white
Hängeleuchte; Stahl, schwarz / Kunststoff, weiss
luminaire en suspension; acier, noir / plastique, blanc



smooth dimming via remote control or app / stufenlos dimmbar über Fernbedienung oder App / Graduation continue par télécommande ou l'application

96979

96819 BERAMO-C

H 70, Ø 290

Socket:	LED
Power:	17 W
Lumen:	2100lm

wall / ceiling luminaire; steel, white / plastic, white
Wand- / Deckenleuchte; Stahl, weiss / Kunststoff, weiss
applique / plafonnier; acier, blanc / plastique, blanc



96686 CAPASSO-C

H 85, Ø 340

Socket:	LED
Power:	17 W
Lumen:	2100lm

wall / ceiling luminaire; steel, white / plastic, white, chrome
Wand- / Deckenleuchte; Stahl, weiss / Kunststoff, weiss,
chrom
applique / plafonnier; acier, blanc / plastique, blanc, chrome



96821 CAPASSO-C

H 70, Ø 340

Socket:	LED
Power:	17 W
Lumen:	2100lm

wall / ceiling luminaire; steel, white / plastic, white, chrome
Wand- / Deckenleuchte; Stahl, weiss / Kunststoff, weiss,
chrom
applique / plafonnier; acier, blanc / plastique, blanc, chrome



smooth dimming via remote control or app / stufenlos dimmbar über Fernbedienung oder App / Graduation continue par télécommande ou l'application



96818 COMPETA-C

H 90, Ø 430

Socket:	LED
Power:	17 W
Lumen:	2100 lm

wall / ceiling luminaire; steel, white / plastic, white, silver, clear
Wand- / Deckenleuchte; Stahl, weiss / Kunststoff, weiss, silber, klar
applique / plafonnier; acier, blanc / plastique, blanc, argent, clair



32589 GIRON-C

H 90, Ø 300

Socket:	LED
Power:	17 W
Lumen:	2100 lm

wall / ceiling luminaire; steel, white / plastic, white
Wand- / Deckenleuchte; Stahl, weiss / Kunststoff, weiss
applique / plafonnier; acier, blanc / plastique, blanc



96684 VOLTAGO-C

H 95, Ø 380

Socket:	LED
Power:	17 W
Lumen:	2100 lm

wall / ceiling luminaire; steel, white / plastic with crystal effect, white
Wand- / Deckenleuchte; Stahl, weiss / Kunststoff m. Kristalleffekt, weiss
applique / plafonnier; acier, blanc / plastique avec effet cristal, blanc



97918 TOTARI-C

Ø 600

Socket: LED

Power: 34W

Lumen: 5400lm

ceiling luminaire; steel, white / plastic, white, chrome

Deckenleuchte; Stahl, weiss / Kunststoff, weiss, chrom

plafonnier; acier, blanc / plastique, blanc, chrome



97922



97921 TOTARI-C

Ø 600

Socket:	LED
Power:	34W
Lumen:	5400lm

ceiling luminaire; steel, white / plastic, white
Deckenleuchte; Stahl, weiss / Kunststoff, weiss
plafonnier; acier, blanc / plastique, blanc



97922 TOTARI-C

Ø 600

Socket:	LED
Power:	34W
Lumen:	5400lm

ceiling luminaire; steel, white / plastic with crystal effect, white
Deckenleuchte; Stahl, weiss / Kunststoff m. Kristalleffekt, weiss
plafonnier; acier, blanc / plastique avec effet cristal, blanc



smooth dimming via remote control or app / stufenlos dimmbar über Fernbedienung oder App / Graduation continue par télécommande ou l'application

97714 CORROPOLI-C

L 80, H 150

Socket:	LED
Power:	1x 5W
Lumen:	1x 600lm

spot; plastic, steel, satin nickel / plastic, white

Spot; Kunststoff, Stahl, nickel-matt / Kunststoff, weiss

spot; plastique, acier, nickel mat / plastique, blanc



97715 CORROPOLI-C

L 365, B 80

Socket:	LED
Power:	2x 5W
Lumen:	2x 600lm

spot; plastic, steel, satin nickel / plastic, white

Spot; Kunststoff, Stahl, nickel-matt / Kunststoff, weiss

spot; plastique, acier, nickel mat / plastique, blanc



97716 CORROPOLI-C

L 590, B 80

Socket:	LED
Power:	3x 5W
Lumen:	3x 600lm

spot; plastic, steel, satin nickel / plastic, white

Spot; Kunststoff, Stahl, nickel-matt / Kunststoff, weiss

spot; plastique, acier, nickel mat / plastique, blanc



smooth dimming via remote control or app / stufenlos dimmbar über Fernbedienung oder App / Graduation continue par télécommande ou l'application



97717 CORROPOLI-C

L 770, B 80

Socket:	LED
Power:	4x 5 W
Lumen:	4x 600 lm

spot; plastic, steel, satin nickel / plastic, white

Spot; Kunststoff, Stahl, nickel-matt / Kunststoff, weiss

spot; plastique, acier, nickel mat / plastique, blanc



97716



97714



CORROPOLI-C

These lamps light to both sides.

Diese Leuchten strahlen nach beiden Seiten.

Ces lampes éclairent sur les deux côtés. These lamps light to both sides.



97691 PALOMBARE-C

L 80, H 150

Socket:	LED
Power:	1x 5W
Lumen:	1x 600lm

spot; plastic, steel, aluminium, white / plastic, white

Spot; Kunststoff, Stahl, Alu, weiss / Kunststoff, weiss

spot; plastique, acier, aluminium, blanc / plastique, blanc



97692 PALOMBARE-C

L 365, B 80

Socket:	LED
Power:	2x 5W
Lumen:	2x 600lm

spot; plastic, steel, aluminium, white / plastic, white

Spot; Kunststoff, Stahl, Alu, weiss / Kunststoff, weiss

spot; plastique, acier, aluminium, blanc / plastique, blanc



97693 PALOMBARE-C

L 590, B 80

Socket:	LED
Power:	3x 5W
Lumen:	3x 600lm

spot; plastic, steel, aluminium, white / plastic, white

Spot; Kunststoff, Stahl, Alu, weiss / Kunststoff, weiss

spot; plastique, acier, aluminium, blanc / plastique, blanc





97694 PALOMBARE-C

L 770, B 80

Socket:	LED
Power:	4x 5 W
Lumen:	4x 600 lm

spot; plastic, steel, aluminium, white / plastic, white

Spot; Kunststoff, Stahl, Alu, weiss / Kunststoff, weiss

spot; plastique, acier, aluminium, blanc / plastique, blanc

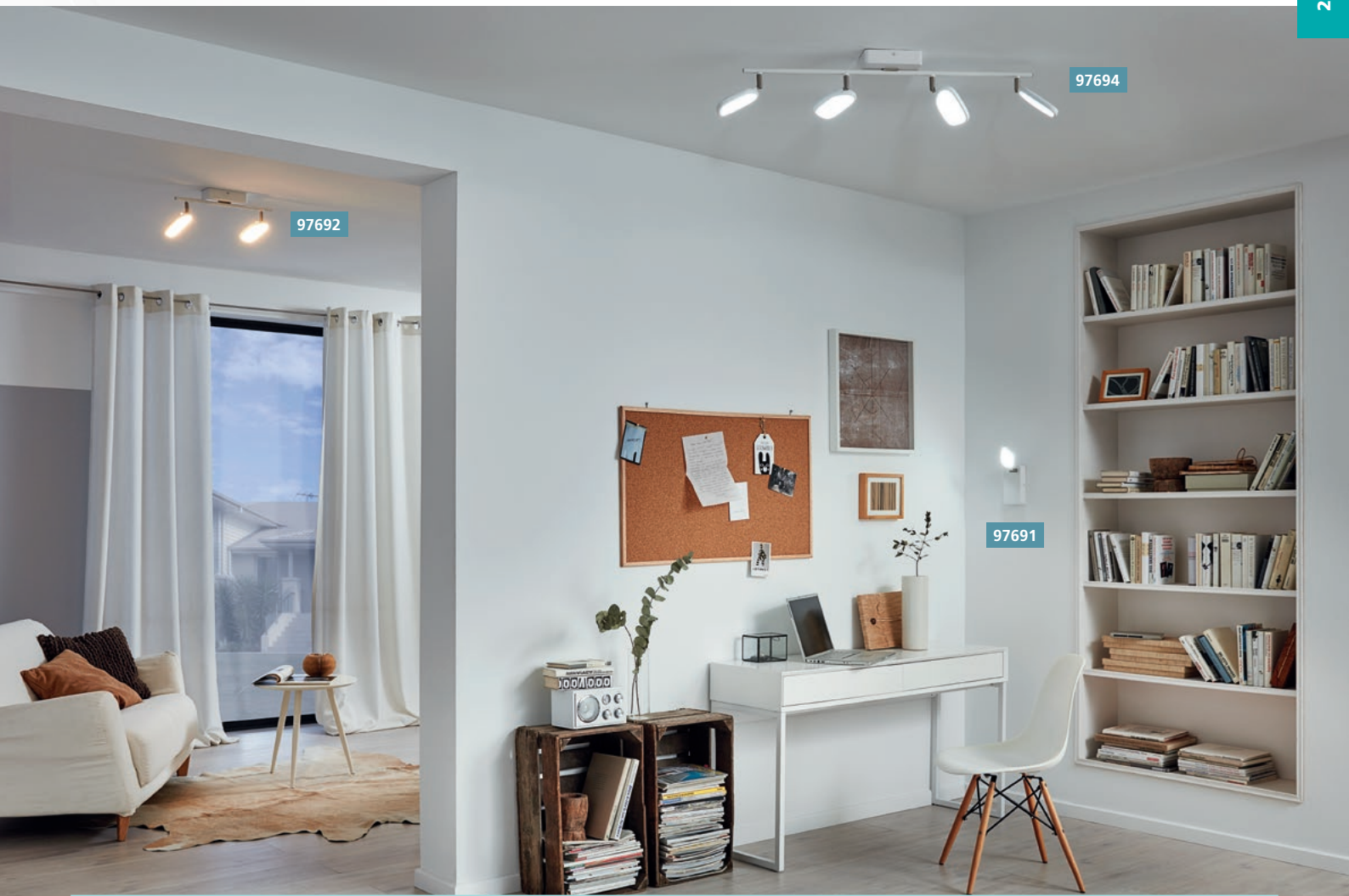

96668 FUEVA-C

Ø 225, ET 30

Socket:	LED
Power:	15,6W
Lumen:	2000lm

recessed luminaire; cast metal, white / plastic, white

Einbauleuchte; Metallguss, weiss / Kunststoff, weiss

luminaire encastrable; fonte métallique, blanc / plastique, blanc

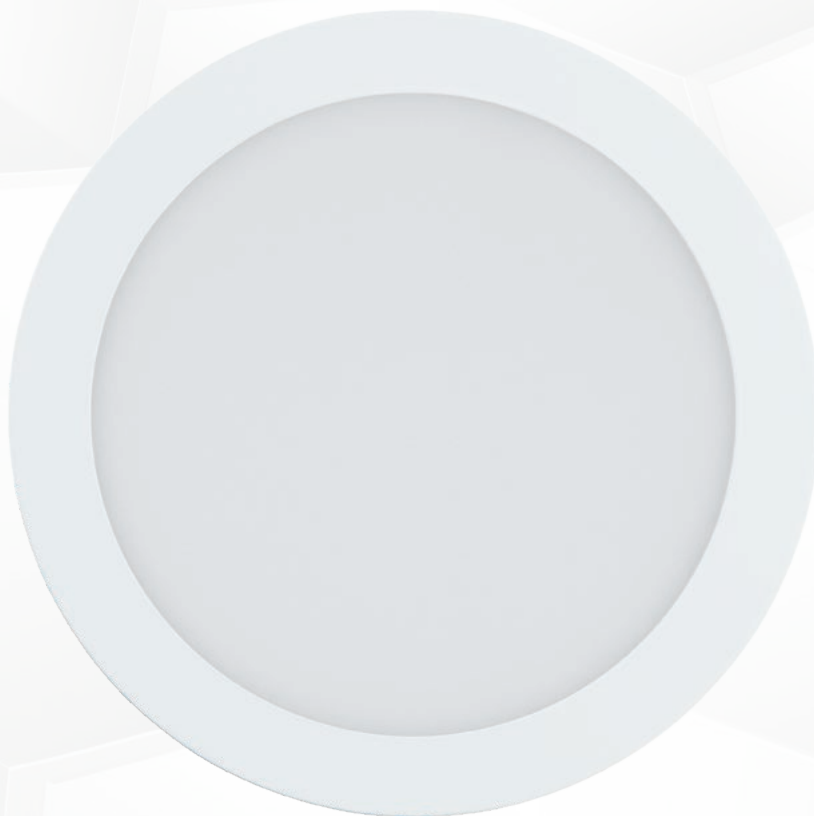

32738 FUEVA-C

Ø 170, ET 30

Socket:	LED
Power:	10,5W
Lumen:	1200lm

recessed luminaire; cast metal, white / plastic, white

Einbauleuchte; Metallguss, weiss / Kunststoff, weiss

luminaire encastrable; fonte métallique, blanc / plastique, blanc

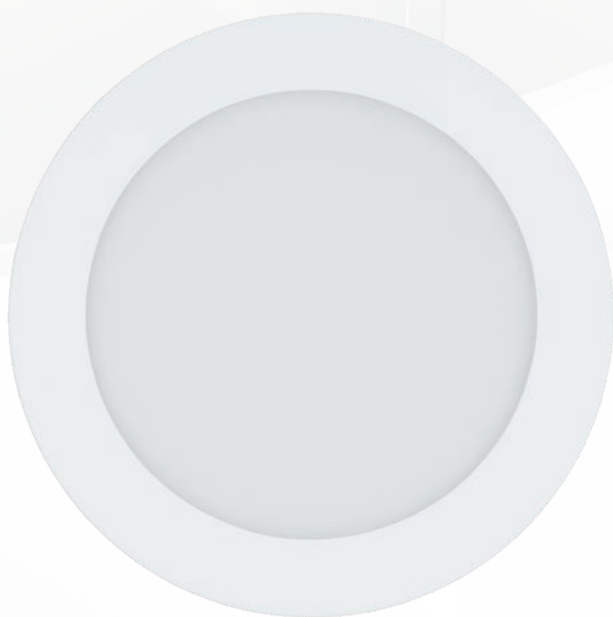

32737 FUEVA-C

Ø 120, ET 30

Socket:	LED
Power:	5,4W
Lumen:	700lm

recessed luminaire; cast metal, white / plastic, white

Einbauleuchte; Metallguss, weiss / Kunststoff, weiss

luminaire encastrable; fonte métallique, blanc / plastique, blanc

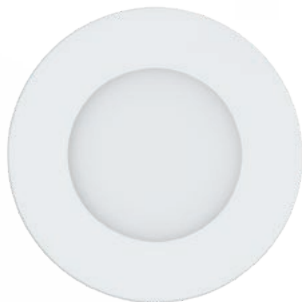
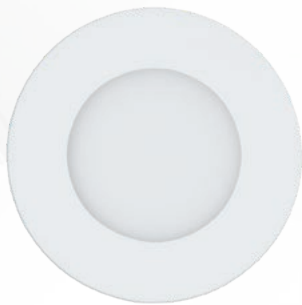
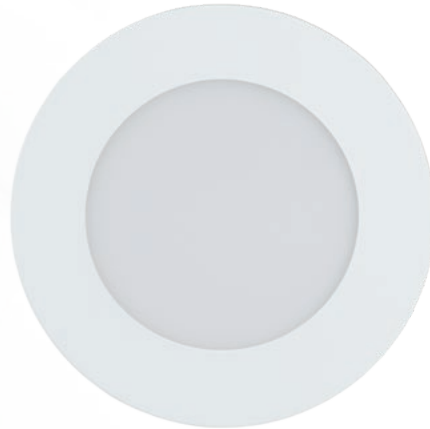

32881 FUEVA-C

Ø 85, ET 30

Socket:	LED
Power:	3x 3W
Lumen:	1080lm

recessed luminaire; cast metal, white / plastic, white

Einbauleuchte; Metallguss, weiss / Kunststoff, weiss

luminaire encastrable; fonte métallique, blanc / plastique, blanc



96676 FUEVA-C

Ø 225, ET 30

Socket:	LED
Power:	15,6W
Lumen:	2000lm

recessed luminaire; cast metal, satin nickel / plastic, white

Einbauleuchte; Metallguss, nickel-matt / Kunststoff, weiss

luminaire encastrable; fonte métallique, nickel mat / plastique, blanc



32754 FUEVA-C

Ø 170, ET 30

Socket:	LED
Power:	10,5W
Lumen:	1200lm

recessed luminaire; cast metal, satin nickel / plastic, white

Einbauleuchte; Metallguss, nickel-matt / Kunststoff, weiss

luminaire encastrable; fonte métallique, nickel mat / plastique, blanc



32753 FUEVA-C

Ø 120, ET 30

Socket:	LED
Power:	5,4W
Lumen:	700lm

recessed luminaire; cast metal, satin nickel / plastic, white

Einbauleuchte; Metallguss, nickel-matt / Kunststoff, weiss

luminaire encastrable; fonte métallique, nickel mat / plastique, blanc





32882 FUEVA-C

Ø 85, ET 30

Socket:	LED
Power:	3x 3W
Lumen:	1080lm

recessed luminaire; cast metal, satin nickel / plastic, white

Einbauleuchte; Metallguss, nickel-matt / Kunststoff, weiss

luminaire encastrable; fonte métallique, nickel mat / plastique, blanc





96671 FUEVA-C

H 40, Ø 300

Socket:	LED
Power:	21 W
Lumen:	2700lm

surface-mounted luminaire; cast metal, white / plastic, white
 Aufbauleuchte; Metallguss, weiss / Kunststoff, weiss
 luminaire en saillie; fonte métallique, blanc / plastique, blanc



96669 FUEVA-C

H 40, Ø 225

Socket:	LED
Power:	15,6W
Lumen:	2000lm

surface-mounted luminaire; cast metal, white / plastic, white
 Aufbauleuchte; Metallguss, weiss / Kunststoff, weiss
 luminaire en saillie; fonte métallique, blanc / plastique, blanc





96673 FUEVA-C

L 300, B 300, H 40

Socket:	LED
Power:	21 W
Lumen:	2700lm

surface-mounted luminaire; cast metal, white / plastic, white
Aufbauleuchte; Metallguss, weiss / Kunststoff, weiss
luminaire en saillie; fonte métallique, blanc / plastique, blanc



96672 FUEVA-C

L 225, B 225, H 40

Socket:	LED
Power:	15,6W
Lumen:	2000lm

surface-mounted luminaire; cast metal, white / plastic, white
Aufbauleuchte; Metallguss, weiss / Kunststoff, weiss
luminaire en saillie; fonte métallique, blanc / plastique, blanc





96678 FUEVA-C

H 40, Ø 300

Socket:	LED
Power:	21 W
Lumen:	2700 lm

surface-mounted luminaire; cast metal, satin nickel / plastic, white

Aufbauleuchte; Metallguss, nickel-matt / Kunststoff, weiss
luminaire en saillie; fonte métallique, nickel mat / plastique, blanc



96677 FUEVA-C

H 40, Ø 225

Socket:	LED
Power:	15,6 W
Lumen:	2000 lm

surface-mounted luminaire; cast metal, satin nickel / plastic, white

Aufbauleuchte; Metallguss, nickel-matt / Kunststoff, weiss
luminaire en saillie; fonte métallique, nickel mat / plastique, blanc



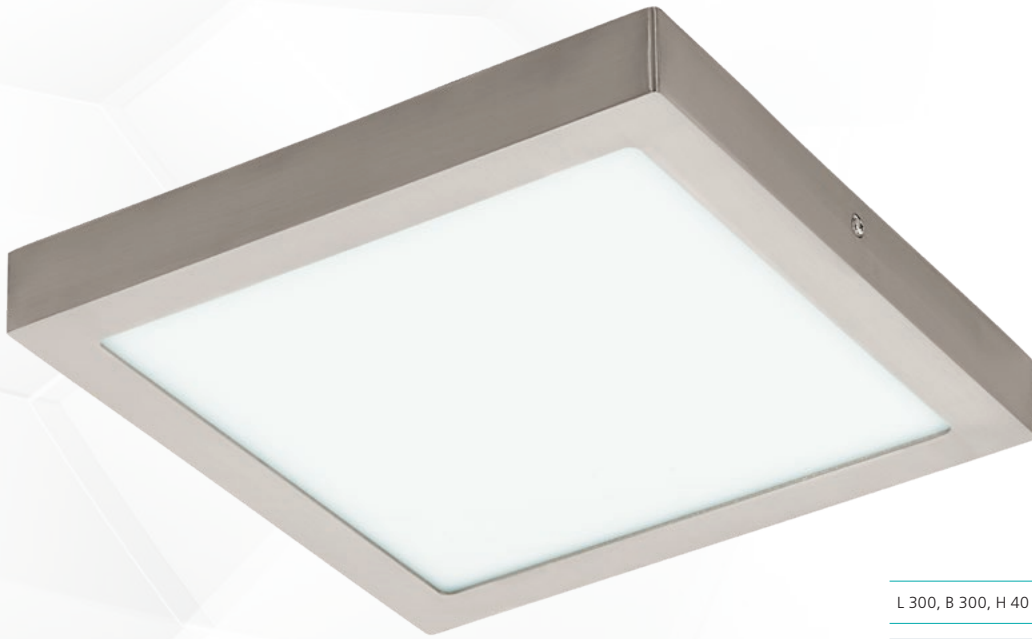

96681 FUEVA-C

L 300, B 300, H 40

Socket:	LED
Power:	21 W
Lumen:	2700 lm

surface-mounted luminaire; cast metal, satin nickel / plastic, white

Aufbauleuchte; Metallguss, nickel-matt / Kunststoff, weiss
luminaire en saillie; fonte métallique, nickel mat / plastique, blanc



96679 FUEVA-C

L 225, B 225, H 40

Socket:	LED
Power:	15,6W
Lumen:	2000lm

surface-mounted luminaire; cast metal, satin nickel / plastic, white

Aufbauleuchte; Metallguss, nickel-matt / Kunststoff, weiss
luminaire en saillie; fonte métallique, nickel mat / plastique, blanc





96662 SALOBRENA-C

L 300, B 300, H 50

Socket:	LED
Power:	16 W
Lumen:	2000 lm

grid luminaire; aluminium, white / plastic, white

Rasterleuchte; Alu, weiss / Kunststoff, weiss

luminaire à grille; aluminium, blanc / plastique, blanc



97629 SALOBRENA-C

L 450, B 450, H 15

Socket:	LED
Power:	21 W
Lumen:	2500 lm

grid luminaire; aluminium, white / plastic, white

Rasterleuchte; Alu, weiss / Kunststoff, weiss

luminaire à grille; aluminium, blanc / plastique, blanc



ACCESSORIES INCLUDED

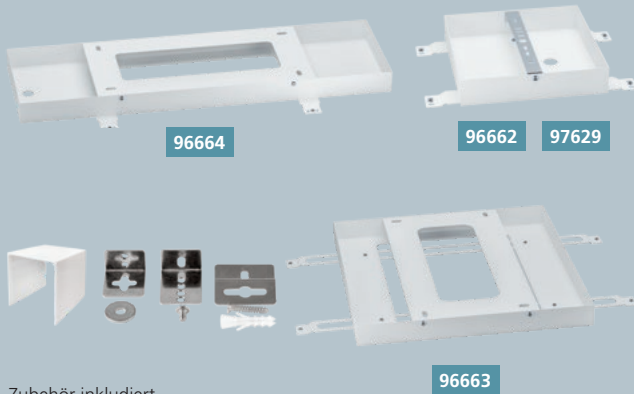

Zubehör inkludiert
Accessoires inclus

OPTIONAL ACCESSORIES



optionales Zubehör
Accessoires optional

see/siehe/voir www.eglo.com



96663 SALOBRENA-C

L 595, B 595, H 50

Socket:	LED
Power:	34 W
Lumen:	4300 lm

grid luminaire; aluminium, white / plastic, white

Rasterleuchte; Alu, weiss / Kunststoff, weiss

luminaire à grille; aluminium, blanc / plastique, blanc





96664 SALOBRENA-C

L 1200, B 300, H 50

Socket:	LED
Power:	34W
Lumen:	4300lm

grid luminaire; aluminium, white / plastic, white

Rasterleuchte; Alu, weiss / Kunststoff, weiss

luminaire à grille; aluminium, blanc / plastique, blanc



97959 SARSINA-C

H 50, Ø 450

Socket:	LED
Power:	21 W
Lumen:	2900 lm

ceiling luminaire; aluminium, white / plastic, white

Deckenleuchte; Alu, weiss / Kunststoff, weiss

plafonnier; aluminium, blanc / plastique, blanc



97961 SARSINA-C

H 50, Ø 600

Socket:	LED
Power:	34 W
Lumen:	4250 lm

ceiling luminaire; aluminium, white / plastic, white

Deckenleuchte; Alu, weiss / Kunststoff, weiss

plafonnier; aluminium, blanc / plastique, blanc



97958 SARSINA-C

H 50, Ø 300

Socket:	LED
Power:	16 W
Lumen:	2100 lm

ceiling luminaire; aluminium, white / plastic, white

Deckenleuchte; Alu, weiss / Kunststoff, weiss

plafonnier; aluminium, blanc / plastique, blanc





5m

32733 STRIPE-C

L 5000, B 12, H 3

Socket:	LED
Power:	19W
Lumen:	2000lm

bar / strip luminaire; plastic, white

Leuchtband/-stab; Kunststoff, weiss

bande lumineuse / bâton l; plastique, blanc



3m

32741 STRIPE-C

L 3000, B 12, H 3

Socket:	LED
Power:	11,4W
Lumen:	1200lm

bar / strip luminaire; plastic, white

Leuchtband/-stab; Kunststoff, weiss

bande lumineuse / bâton l; plastique, blanc



OUTDOOR LUMINAIRES

AUSSENLEUCHTEN
LUMINAIRES EXTÉRIEURS





CONNECT SENSOR
44



CALDIERO-C
46



CALDIERO-C
46



CALDIERO-C
46



CALDIERO-C
47



NISIA-C
48



NISIA-C
48



NISIA-C
48



LOCANA-C
49



LOCANA-C
49



PIOVE-C
49



TORAZZA-C
50



VERRES-C
50



MONTEROLO-C
52



MONTEROLO-C
52



MONTEROLO-C
52



MONTEROLO-C
53



VERLUCCA-C
54



VERLUCCA-C
54



Mounting bracket incl.
Montagehalterung inkl.
Support de montage incl.

97475 CONNECT SENSOR

L 60, H 60, A 40



120°, 12 m
20 sec. - 10 min.

accessory; plastic, white

Zubehör; Kunststoff, weiss

accessoire; plastique, blanc

Advantages of the CONNECT SENSOR

- › **IP44 Safty**
- › **No cabling necessary**
The CONNECT SENSOR is battery-operated, so that no difficult cabling is necessary. The sensor can be mounted directly on the wall. With the mounting bracket (included in the delivery), you can easily adjust the detection range to your needs. This permits fine adjustment by 30 degrees to all directions.
- › **Night mode**
The Night mode allows automatic switching when the preset brightness threshold is reached. Choose from 3 sensitivity settings (25 to 75%).
- › **Movement detection**
When Night movement detection is enabled the CONNECT SENSOR turns on the luminaires with the chosen light intensity when movement is detected. You can choose from 3 movement detection sensibility settings. The light will turn off after the selected time when no movement is detected.
- › **Night mode and motion detection can be used separately or in combination.**

Vorteile des CONNECT SENSOR

- › **IP44 Schutz**
- › **Keine Verkabelung notwendig**
Der CONNECT SENSOR ist batteriebetrieben, so dass keine schwierige Verkabelung erforderlich ist. Der Sensor kann direkt an die Wand montiert werden. Mit der Montagehalterung (im Lieferumfang enthalten) kannst du den Erfassungsbereich ganz einfach an deine Bedürfnisse anpassen. Dadurch ist eine Feinjustierung von 30 Grad in alle Richtungen möglich.
- › **Nachtmodus**
Der Nachtmodus ermöglicht das automatische Einschalten bei Erreichen der voreingestellten Helligkeitsschwelle. Wähle aus 3 Empfindlichkeitseinstellungen (25 bis 75%).
- › **Bewegungserkennung**
Wenn eine Bewegung detektiert wird, schaltet der CONNECT SENSOR die Leuchten mit der voreingestellten Lichtintensität ein. Du kannst aus 3 Sensibilitätseinstellungen wählen. Das Licht schaltet sich nach der definierten Zeit wieder aus, wenn keine weitere Bewegung erkannt wird.
- › **Nachtmodus und Bewegungserkennung können getrennt oder in Kombination verwendet werden.**

Avantages du CAPTEUR CONNECT

- › **Protection IP44**
- › **Aucun câble nécessaire**
Le CONNECT SENSOR est alimenté par batterie, donc aucun câblage difficile n'est nécessaire. Avec le support de montage (inclus dans la livraison), tu peux facilement ajuster l'étendue de la détection à tes besoins. Ce faisant, un réglage de 30 degrés dans toutes les directions est possible.
- › **Mode de nuit (Night mode)**
Le mode nuit permet l'allumage automatique lorsque le seuil de luminosité préreglé est atteint. Choisis parmi 3 réglages de sensibilité (de 25 à 75%).
- › **Détection de mouvement**
Lorsque la détection de mouvement nocturne est activée, le CONNECT SENSOR allume les luminaires avec l'intensité lumineuse présélectionnée lorsqu'un mouvement est détecté. Tu peux choisir parmi 3 réglages de sensibilité de détection de mouvement. Si aucun mouvement n'est détecté, la lumière s'éteindra après la période sélectionnée.
- › **Le mode nuit et la détection de mouvement peuvent être utilisés séparément ou en combinaison.**

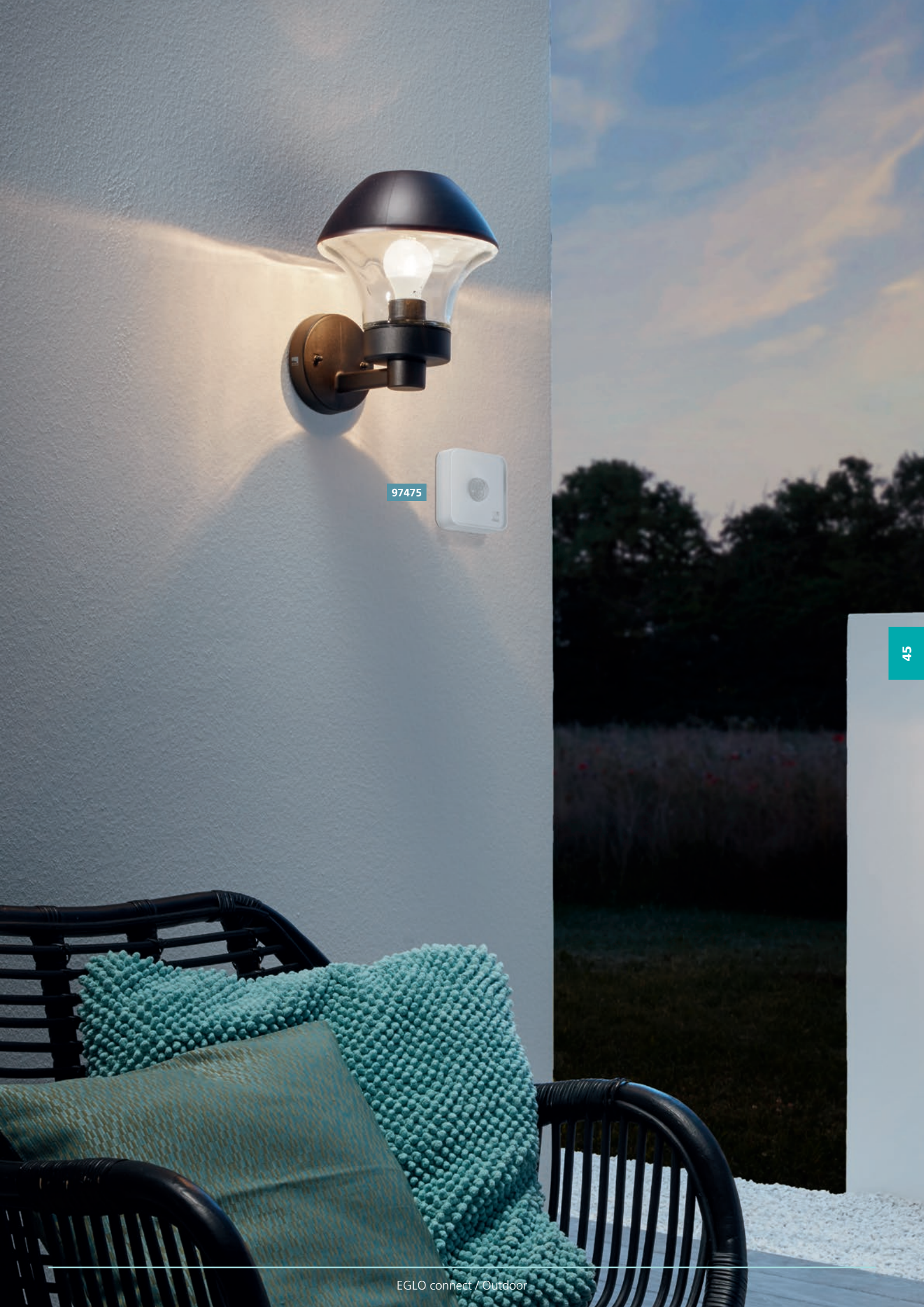

97475



97482 CALDIERO-C

L 140, H 240, A 190

Socket:	E27
Power:	1x 9W
Lumen:	1x 806lm

wall luminaire; zinc-plated steel, anthracite / plastic, white
Wandleuchte; Stahl verzinkt, anthrazit / Kunststoff, weiss
applique; acier galvanisé, anthracite / plastique, blanc



97484 CALDIERO-C

L 140, H 240, A 190

Socket:	E27
Power:	1x 9W
Lumen:	1x 806lm

wall luminaire; stainless steel, stainless steel / plastic, white
Wandleuchte; Edelstahl, edelstahl / Kunststoff, weiss
applique; acier inoxydable, acier inoxydable / plastique, blanc



97483 CALDIERO-C

L 240, B 140, H 965, Base: Ø 140

Socket:	E27
Power:	1x 9W
Lumen:	1x 806lm

floor luminaire; zinc-plated steel, anthracite / plastic, white
Stehleuchte; Stahl verzinkt, anthrazit / Kunststoff, weiss
lampadaire; acier galvanisé, anthracite / plastique, blanc



smooth dimming via remote control or app / stufenlos dimmbar über Fernbedienung oder App / Graduation continue par télécommande ou l'application



97485 CALDIERO-C

L 240, B 140, H 965, Base: Ø 140

Socket:	E27
Power:	1x 9W
Lumen:	1x 806lm

floor luminaire; stainless steel, stainless steel / plastic, white
Stehleuchte; Edelstahl, edelstahl / Kunststoff, weiss
lampadaire; acier inoxydable, acier inoxydable / plastique,
blanc



97484



97247 NISIA-C

L 200, H 315, A 220

Socket:	E27
Power:	1x 9W
Lumen:	1x 806lm

wall luminaire; stainless steel, stainless steel / plastic, white
Wandleuchte; Edelstahl, edelstahl / Kunststoff, weiss
applique; acier inoxydable, acier inoxydable / plastique, blanc



97248 NISIA-C

H 525, Ø 200, Base: Ø 140

Socket:	E27
Power:	1x 9W
Lumen:	1x 806lm

pedestal luminaire; stainless steel, stainless steel / plastic, white

Sockelleuchte; Edelstahl, edelstahl / Kunststoff, weiss
luminaire pour socle; acier inoxydable, acier inoxydable / plastique, blanc



97249 NISIA-C

H 980, Ø 200, Base: Ø 140

Socket:	E27
Power:	1x 9W
Lumen:	1x 806lm

floor luminaire; stainless steel, stainless steel / plastic, white
Stehleuchte; Edelstahl, edelstahl / Kunststoff, weiss
lampadaire; acier inoxydable, acier inoxydable / plastique, blanc



97237 LOCANA-C

H 95, Ø 260

Socket:	LED
Power:	14W
Lumen:	1400lm

wall / ceiling luminaire; zinc-plated steel, anthracite / plastic, white

Wand- / Deckenleuchte; Stahl verzinkt, anthrazit / Kunststoff, weiss

applique / plafonnier; acier galvanisé, anthracite / plastique, blanc



97299 LOCANA-C

H 95, Ø 260

Socket:	LED
Power:	14W
Lumen:	1400lm

wall / ceiling luminaire; zinc-plated steel, silver / plastic, white

Wand- / Deckenleuchte; Stahl verzinkt, silber / Kunststoff, weiss

applique / plafonnier; acier galvanisé, argent / plastique, blanc



97295 PIOVE-C

L 250, H 250, A 80

Socket:	LED
Power:	14W
Lumen:	1400lm

wall / ceiling luminaire; cast aluminium, black / plastic, white

Wand- / Deckenleuchte; Aluguss, schwarz / Kunststoff, weiss

applique / plafonnier; fonte d'aluminium, noir / plastique, blanc



97239 VERRES-C

L 180, H 290, A 90

Socket:	E27
Power:	1x 9W
Lumen:	1x 806lm

wall luminaire; stainless steel, plastic, stainless steel, white / plastic, white

Wandleuchte; Edelstahl, Kunststoff, edelstahl, weiss / Kunststoff, weiss

applique; acier inoxydable, plastique, acier inoxydable, blanc / plastique, blanc



97219 TORAZZA-C

L 215, H 215, A 70

Socket:	LED
Power:	14W
Lumen:	1400lm

wall luminaire; plastic, steel, anthracite / plastic, satiné

Wandleuchte; Kunststoff, Stahl, anthrazit / Kunststoff, satiné

applique; plastique, acier, anthracite / plastique, satiné





97219



98108 MONTEROLO-C

H 600, Ø 600, Base: Ø 195

Socket:	E27
Power:	1x 9W
Lumen:	1x 806lm

floor luminaire; plastic, white / plastic, white

Stehleuchte; Kunststoff, weiss / Kunststoff, weiss

lampadaire; plastique, blanc / plastique, blanc



98107 MONTEROLO-C

H 500, Ø 500, Base: Ø 195

Socket:	E27
Power:	1x 9W
Lumen:	1x 806lm

floor luminaire; plastic, white / plastic, white

Stehleuchte; Kunststoff, weiss / Kunststoff, weiss

lampadaire; plastique, blanc / plastique, blanc



98106 MONTEROLO-C

H 390, Ø 390, Base: Ø 195

Socket:	E27
Power:	1x 9W
Lumen:	1x 806lm

floor luminaire; plastic, white / plastic, white

Stehleuchte; Kunststoff, weiss / Kunststoff, weiss

lampadaire; plastique, blanc / plastique, blanc



smooth dimming via remote control or app / stufenlos dimmbar über Fernbedienung oder App / Graduation continue par télécommande ou l'application

98105 MONTEROLO-C

H 300, Ø 300, Base: Ø 120

Socket:	E27
Power:	1x 9W
Lumen:	1x 806lm

floor luminaire; plastic, white / plastic, white
Stehleuchte; Kunststoff, weiss / Kunststoff, weiss
lampadaire; plastique, blanc / plastique, blanc





97446 VERLUCCA-C

L 210, H 265, A 245

Socket:	E27
Power:	1x 9W
Lumen:	1x 806lm

wall luminaire; zinc-plated steel, black / glass, clear, black
Wandleuchte; Stahl verzinkt, schwarz / Glas, klar, schwarz
applique; acier galvanisé, noir / verre, clair, noir



97447 VERLUCCA-C

H 990, Ø 210, Base: Ø 140

Socket:	E27
Power:	1x 9W
Lumen:	1x 806lm

floor luminaire; zinc-plated steel, black / glass, clear, black
Stehleuchte; Stahl verzinkt, schwarz / Glas, klar, schwarz
lampadaire; acier galvanisé, noir / verre, clair, noir



smooth dimming via remote control or app / stufenlos dimmbar über Fernbedienung oder App / Graduation continue par télécommande ou l'application



97446

ILLUMINANTS

LEUCHTMITTEL
AMPOULES



5 year warranty
Jahre Garantie
ans de garantie
anni di garanzia
años de garantía



806 lm
LUMEN

9W

11585

Dimensions Abmessungen / dimensions	L 116, Ø 60
Socket Socket / douille	E27
Wattage Wattage / puissance	9W
Light Colour Lichtfarbe / couleur lumineuse	2700-6500K
Operating voltage Betriebsspannung / tension de fonctionnement	220-240V,50/60Hz
Switching cycles Schaltzyklen / cycles de fonctionnement	15.000 x
Operating hours Betriebsstunden / heures de fonctionnement	25.000 h
Colour rendering index Farbwiedergabeindex / L'indice de restitution de couleurs	>80

11586

Dimensions Abmessungen / dimensions	L 116, Ø 60
Socket Socket / douille	E27
Wattage Wattage / puissance	9W
Light Colour Lichtfarbe / couleur lumineuse	2700-6500K
Operating voltage Betriebsspannung / tension de fonctionnement	220-240V,50/60Hz
Switching cycles Schaltzyklen / cycles de fonctionnement	15.000 x
Operating hours Betriebsstunden / heures de fonctionnement	25.000 h
Colour rendering index Farbwiedergabeindex / L'indice de restitution de couleurs	>80

9W

806 lm
LUMEN



5 year warranty
Jahre Garantie
ans de garantie
anni di garanzia
años de garantía



5 year warranty
Jahre Garantie
ans de garantie
anni di garanzia
años de garantía



1300 lm
LUMEN

13W

11659

Dimensions Abmessungen / dimensions	L 136, Ø 95
Socket Socket / douille	E27
Wattage Wattage / puissance	13W
Light Colour Lichtfarbe / couleur lumineuse	2700-6500K
Operating voltage Betriebsspannung / tension de fonctionnement	220-240V,50/60Hz
Switching cycles Schaltzyklen / cycles de fonctionnement	15.000 x
Operating hours Betriebsstunden / heures de fonctionnement	25.000 h
Colour rendering index Farbwiedergabeindex / L'indice de restitution de couleurs	>80

5 year warranty
Jahre Garantie
ans de garantie
anni di garanzia
años de garantía



9W

60W



9 002759 116842



11684

Dimensions Abmessungen / dimensions	L 118, Ø 60
Socket Socket / douille	E27
Wattage Wattage / puissance	9W
Light Colour Lichtfarbe / couleur lumineuse	3000K
Operating voltage Betriebsspannung / tension de fonctionnement	220-240V,50/60Hz
Switching cycles Schaltzyklen / cycles de fonctionnement	15.000 x
Operating hours Betriebsstunden / heures de fonctionnement	25.000 h
Colour rendering index Farbwiedergabeindex / L'indice de restitution de couleurs	>80

11671

Dimensions Abmessungen / dimensions	L 68, Ø 50
Socket Socket / douille	GU10
Wattage Wattage / puissance	5W
Light Colour Lichtfarbe / couleur lumineuse	2700- 6500 K
Operating voltage Betriebsspannung / tension de fonctionnement	220-240V,50/60Hz
Switching cycles Schaltzyklen / cycles de fonctionnement	15.000 x
Operating hours Betriebsstunden / heures de fonctionnement	25.000 h
Colour rendering index Farbwiedergabeindex / L'indice de restitution de couleurs	>80
Beamangle Ausstrahlwinkel / angle de rayonnement	70°

5W

400 lm
LUMEN



5 year warranty
Jahre Garantie
ans de garantie
anni di garanzia
años de garantía



5W



29W



9 002759 116712

5 year warranty
Jahre Garantie
ans de garantie
anni di garanzia
años de garantía



5W

38W



9 002759 116729



11672

Dimensions Abmessungen / dimensions	L 90, Ø 50
Socket Socket / douille	E14
Wattage Wattage / puissance	5W
Light Colour Lichtfarbe / couleur lumineuse	2700- 6500K
Operating voltage Betriebsspannung / tension de fonctionnement	220-240V,50/60Hz
Switching cycles Schaltzyklen / cycles de fonctionnement	15.000 x
Operating hours Betriebsstunden / heures de fonctionnement	25.000 h
Colour rendering index Farbwiedergabeindex / L'indice de restitution de couleurs	>80



TECHNICAL DESCRIPTIONS

TECHNISCHE BESCHREIBUNG
DESCRIPTIONS TECHNIQUES



97476 PLUG

L 62, H 110, A 35

plug; plastic, white
Stecker; Kunststoff, weiss
priseconnecteur; plastique, blanc

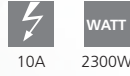

97936 PLUG PLUS

plug; plastic, white
Stecker; Stecker; Kunststoff, weiss
connecteur; plastique, blanc



32732 REMOTE

L 110, B 53, H 20

remote control; plastic, white
Fernbedienung; Kunststoff, weiss
télécommande; plastique, blanc

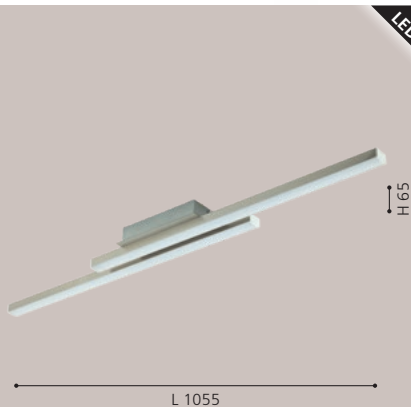

97906 FRAIOLI-C

L 1055, B 120, H 65

ceiling luminaire; aluminium, satin nickel / plastic, white
Deckenleuchte; Alu, nickel-matt / Kunststoff, weiss
plafonnier; aluminium, nickel mat / plastique, blanc



PAGE
SEITE
PAGE

14



97907 FRAIOLI-C

L 1055, B 100, H 1200

pendant luminaire; aluminium, satin nickel / plastic, white
Hängeleuchte; Alu, nickel-matt / Kunststoff, weiss
luminaire en suspension; aluminium, nickel mat / plastique, blanc



2x 17W 4600lm



PAGE
SEITE
PAGE

14



97908 FRAIOLI-C

H 1755, Base: B 280, T 280

floor luminaire; aluminium, satin nickel / plastic, white
Stehleuchte; Alu, nickel-matt / Kunststoff, weiss
lampadaire; aluminium, nickel mat / plastique, blanc



2x 17W 4600lm



PAGE
SEITE
PAGE

15

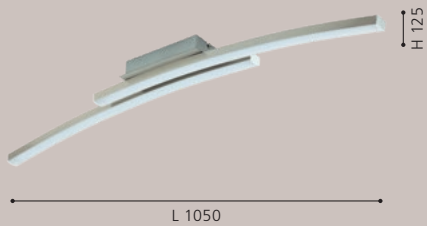

97909 FRAIOLI-C

L 1050, B 120, H 125

ceiling luminaire; aluminium, satin nickel / plastic, white
Deckenleuchte; Alu, nickel-matt / Kunststoff, weiss
plafonnier; aluminium, nickel mat / plastique, blanc



2x 17W 4600lm



PAGE
SEITE
PAGE

15



97911 FRAIOLI-C

L 1050, B 100, H 1200

pendant luminaire; aluminium, satin nickel / plastic, white
Hängeleuchte; Alu, nickel-matt / Kunststoff, weiss
luminaire en suspension; aluminium, nickel mat / plastique, blanc

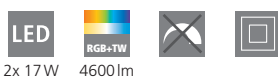

2x 17W 4600lm



**97812 FRATTINA-C****H 1500, Ø 435**

pendant luminaire; steel, satin nickel / plastic, white
 Hängeleuchte; Stahl, nickel-matt / Kunststoff, weiss
 luminaire en suspension; acier, nickel mat / plastique, blanc



27W



3400lm



9 002759 978129

A+

**97811 FRATTINA-C****H 130, Ø 435**

ceiling luminaire; steel, satin nickel / plastic, white
 Deckenleuchte; Stahl, nickel-matt / Kunststoff, weiss
 plafonnier; acier, nickel mat / plastique, blanc



27W



3400lm



9 002759 978112

A+

**97813 FRATTINA-C****H 115, Ø 290, Base: Ø 200**

table luminaire; steel, satin nickel / plastic, white
 Tischleuchte; Stahl, nickel-matt / Kunststoff, weiss
 luminaire de table; acier, nickel mat / plastique, blanc



18W



2300lm



9 002759 978136

A+

**97814 FRATTINA-C****H 1815, Ø 290, Base: Ø 300**

floor luminaire; steel, satin nickel / plastic, white
 Stehleuchte; Stahl, nickel-matt / Kunststoff, weiss
 lampadaire; acier, nickel mat / plastique, blanc



18W



2300lm



9 002759 978143

A+

PAGE
SEITE
PAGE

18



LED

96996 RIODEVA-C

H 105, Ø 445

ceiling luminaire; steel, black / plastic, white
Deckenleuchte; Stahl, schwarz / Kunststoff, weiss
plafonnier; acier, noir / plastique, blanc

LED

27W

RGB+TW

3400lm



A+

PAGE
SEITE
PAGE

18



LED

96997 RIODEVA-C

H 1500, Ø 445

pendant luminaire; steel, black / plastic, white
Hängeleuchte; Stahl, schwarz / Kunststoff, weiss
luminaire en suspension; acier, noir / plastique, blanc

LED

27W

RGB+TW

3400lm



A+

PAGE
SEITE
PAGE

20



LED

97087 COMBA-C

H 1500, Ø 290

pendant luminaire; steel, white, copper / plastic, white
Hängeleuchte; Stahl, weiss, kupfer / Kunststoff, weiss
luminaire en suspension; acier, blanc, cuivre / plastique, blanc

LED

18W

RGB+TW

2300lm



A+

PAGE
SEITE
PAGE

20



LED

96978 MONEVA-C

H 1500, Ø 405

pendant luminaire; steel, black / plastic, white
Hängeleuchte; Stahl, schwarz / Kunststoff, weiss
luminaire en suspension; acier, noir / plastique, blanc

LED

18W

RGB+TW

2300lm



A+

PAGE
SEITE
PAGE

20



96979 MONEVA-C

H 1500, Ø 485

pendant luminaire; steel, black / plastic, white
Hängeleuchte; Stahl, schwarz / Kunststoff, weiss
luminaire en suspension; acier, noir / plastique, blanc

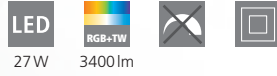

A+

PAGE
SEITE
PAGE

22

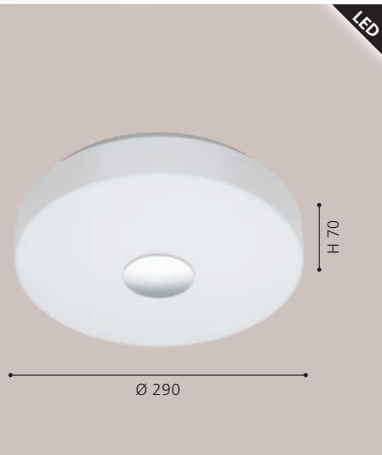

96819 BERAMO-C

H 70, Ø 290

wall / ceiling luminaire; steel, white / plastic, white
Wand- / Deckenleuchte; Stahl, weiss / Kunststoff, weiss
applique / plafonnier; acier, blanc / plastique, blanc



A+

PAGE
SEITE
PAGE

22



96686 CAPASSO-C

H 85, Ø 340

wall / ceiling luminaire; steel, white / plastic, white, chrome
Wand- / Deckenleuchte; Stahl, weiss / Kunststoff, weiss, chrom
applique / plafonnier; acier, blanc / plastique, blanc, chrome



A+

PAGE
SEITE
PAGE

22

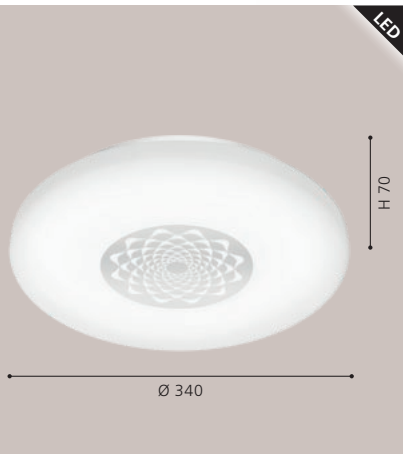

96821 CAPASSO-C

H 70, Ø 340

wall / ceiling luminaire; steel, white / plastic, white, chrome
Wand- / Deckenleuchte; Stahl, weiss / Kunststoff, weiss, chrom
applique / plafonnier; acier, blanc / plastique, blanc, chrome

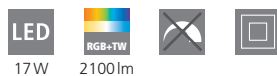

A+

smooth dimming via remote control or app / stufenlos dimmbar über Fernbedienung oder App / Graduation continue par télécommande ou l'application

PAGE
SEITE
PAGE

23

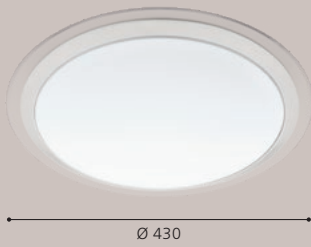

LED

96818 COMPETA-C

H 90, Ø 430

wall / ceiling luminaire; steel, white / plastic, white, silver, clear
Wand- / Deckenleuchte; Stahl, weiss / Kunststoff, weiss, silber, klar
applique / plafonnier; acier, blanc / plastique, blanc, argent, clair

LED

17W

RGB+TW

2100lm



9 002759 968182

A+

PAGE
SEITE
PAGE

23



LED

32589 GIRON-C

H 90, Ø 300

wall / ceiling luminaire; steel, white / plastic, white
Wand- / Deckenleuchte; Stahl, weiss / Kunststoff, weiss
applique / plafonnier; acier, blanc / plastique, blanc

LED

17W

RGB+TW

2100lm



9 002759 325893

A+

PAGE
SEITE
PAGE

23

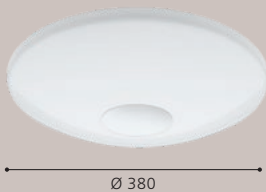

LED

96684 VOLTAGO-C

H 95, Ø 380

wall / ceiling luminaire; steel, white / plastic with crystal effect, white
Wand- / Deckenleuchte; Stahl, weiss / Kunststoff m.Kristalleffekt, weiss
applique / plafonnier; acier, blanc / plastique avec effet cristal, blanc

LED

17W

RGB+TW

2100lm



9 002759 966843

A+

PAGE
SEITE
PAGE

24



LED

97918 TOTARI-C

Ø 600

ceiling luminaire; steel, white / plastic, white, chrome
Deckenleuchte; Stahl, weiss / Kunststoff, weiss, chrom
plafonnier; acier, blanc / plastique, blanc, chrome

LED

34W

RGB+TW

5400lm



9 002759 979188

A++

incl.

PAGE
SEITE
PAGE

25



incl.



Ø 600

LED

97921 TOTARI-C

Ø 600

ceiling luminaire; steel, white / plastic, white
Deckenleuchte; Stahl, weiss / Kunststoff, weiss
plafonnier; acier, blanc / plastique, blanc

LED

34W

RGB+TW

5400lm



9 002759 979218



PAGE
SEITE
PAGE

25



incl.



Ø 600

LED

97922 TOTARI-C

Ø 600

ceiling luminaire; steel, white / plastic with crystal effect, white
Deckenleuchte; Stahl, weiss / Kunststoff m.Kristalleffekt, weiss
plafonnier; acier, blanc / plastique avec effet cristal, blanc

LED

34W

RGB+TW

5400lm



9 002759 979225



PAGE
SEITE
PAGE

26



L 80

H 150

LED

97714 CORROPOLI-C

L 80, H 150

spot; plastic, steel, satin nickel / plastic, white
Spot; Kunststoff, Stahl, nickel-matt / Kunststoff, weiss
spot; plastique, acier, nickel mat / plastique, blanc

LED

1x 5W

RGB+TW

1x
600lm



9 002759 977146



PAGE
SEITE
PAGE

26



L 365

LED

97715 CORROPOLI-C

L 365, B 80

spot; plastic, steel, satin nickel / plastic, white
Spot; Kunststoff, Stahl, nickel-matt / Kunststoff, weiss
spot; plastique, acier, nickel mat / plastique, blanc

LED

2x 5W

RGB+TW

2x
600lm



9 002759 977153



smooth dimming via remote control or app / stufenlos dimmbar über Fernbedienung oder App / Graduation continue par télécommande ou l'application

PAGE
SEITE
PAGE

26



97716 CORROPOLI-C

L 590, B 80

spot; plastic, steel, satin nickel / plastic, white
Spot; Kunststoff, Stahl, nickel-matt / Kunststoff, weiss
spot; plastique, acier, nickel mat / plastique, blanc

LED

3x 5W

RGB+TW

3x
600lm



9 002759 977160



PAGE
SEITE
PAGE

27



97717 CORROPOLI-C

L 770, B 80

spot; plastic, steel, satin nickel / plastic, white
Spot; Kunststoff, Stahl, nickel-matt / Kunststoff, weiss
spot; plastique, acier, nickel mat / plastique, blanc

LED

4x 5W

RGB+TW

4x
600lm



9 002759 977177



PAGE
SEITE
PAGE

28



97691 PALOMBARE-C

L 80, H 150

spot; plastic, steel, aluminium, white / plastic, white
Spot; Kunststoff, Stahl, Alu, weiss / Kunststoff, weiss
spot; plastique, acier, aluminium, blanc / plastique, blanc

LED

1x 5W

RGB+TW

1x
600lm



9 002759 976910



PAGE
SEITE
PAGE

28

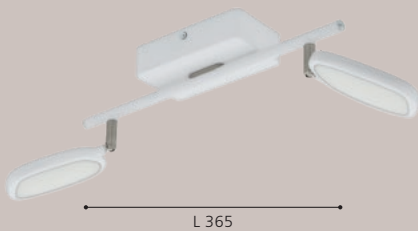

97692 PALOMBARE-C

L 365, B 80

spot; plastic, steel, aluminium, white / plastic, white
Spot; Kunststoff, Stahl, Alu, weiss / Kunststoff, weiss
spot; plastique, acier, aluminium, blanc / plastique, blanc

LED

2x 5W

RGB+TW

2x
600lm



9 002759 976927



PAGE
SEITE
PAGE

28

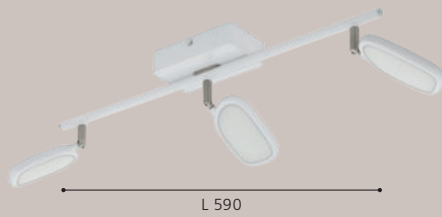

97693 PALOMBARE-C

L 590, B 80

spot; plastic, steel, aluminium, white / plastic, white
Spot; Kunststoff, Stahl, Alu, weiss / Kunststoff, weiss
spot; plastique, acier, aluminium, blanc / plastique, blanc



3x 5W



3x
600lm



9 002759 976934



PAGE
SEITE
PAGE

29

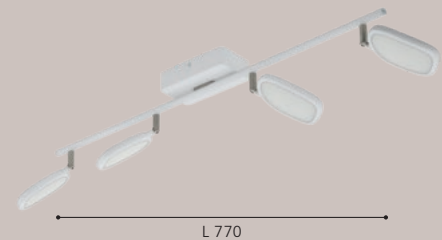

97694 PALOMBARE-C

L 770, B 80

spot; plastic, steel, aluminium, white / plastic, white
Spot; Kunststoff, Stahl, Alu, weiss / Kunststoff, weiss
spot; plastique, acier, aluminium, blanc / plastique, blanc



4x 5W



4x
600lm



9 002759 976941



PAGE
SEITE
PAGE

31



32737 FUEVA-C

Ø 120, ET 30

recessed luminaire; cast metal, white / plastic, white
Einbauleuchte; Metallguss, weiss / Kunststoff, weiss
luminaire encastrable; fonte métallique, blanc / plastique, blanc



5,4W



700lm



Ø 108



9 002759 327378



PAGE
SEITE
PAGE

30

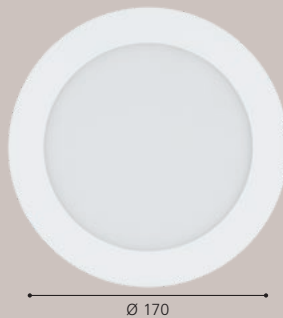

32738 FUEVA-C

Ø 170, ET 30

recessed luminaire; cast metal, white / plastic, white
Einbauleuchte; Metallguss, weiss / Kunststoff, weiss
luminaire encastrable; fonte métallique, blanc / plastique, blanc



10,5W



1200lm



Ø 155



9 002759 327385



smooth dimming via remote control or app / stufenlos dimmbar über Fernbedienung oder App / Graduation continue par télécommande ou l'application

PAGE
SEITE
PAGE

30

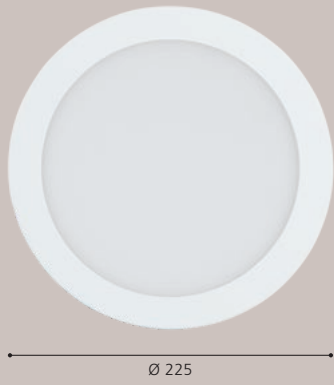

LED

96668 FUEVA-C

Ø 225, ET 30

recessed luminaire; cast metal, white / plastic, white
Einbauleuchte; Metallguss, weiss / Kunststoff, weiss
luminaire encastrable; fonte métallique, blanc / plastique, blanc



15,6W



2000lm



Ø 207



9 002759 966683



PAGE
SEITE
PAGE

31



LED

32881 FUEVA-C

Ø 85, ET 30

recessed luminaire; cast metal, white / plastic, white
Einbauleuchte; Metallguss, weiss / Kunststoff, weiss
luminaire encastrable; fonte métallique, blanc / plastique, blanc



3x 3W



1080lm



Ø 74



9 002759 328818



PAGE
SEITE
PAGE

32



LED

32753 FUEVA-C

Ø 120, ET 30

recessed luminaire; cast metal, satin nickel / plastic, white
Einbauleuchte; Metallguss, nickel-matt / Kunststoff, weiss
luminaire encastrable; fonte métallique, nickel mat / plastique, blanc



5,4W



700lm



Ø 108



9 002759 327538



PAGE
SEITE
PAGE

32



LED

32754 FUEVA-C

Ø 170, ET 30

recessed luminaire; cast metal, satin nickel / plastic, white
Einbauleuchte; Metallguss, nickel-matt / Kunststoff, weiss
luminaire encastrable; fonte métallique, nickel mat / plastique, blanc



10,5W



1200lm



Ø 155



9 002759 327545



PAGE
SEITE
PAGE

32



LED

96676 FUEVA-C

Ø 225, ET 30

recessed luminaire; cast metal, satin nickel / plastic, white
Einbauleuchte; Metallguss, nickel-matt / Kunststoff, weiss
luminaire encastrable; fonte métallique, nickel mat / plastique, blanc



15,6W



2000lm



Ø 207



9 002759 966768



PAGE
SEITE
PAGE

33

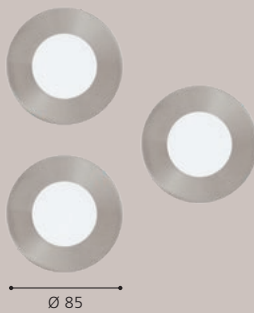

LED

32882 FUEVA-C

Ø 85, ET 30

recessed luminaire; cast metal, satin nickel / plastic, white
Einbauleuchte; Metallguss, nickel-matt / Kunststoff, weiss
luminaire encastrable; fonte métallique, nickel mat / plastique, blanc



3x 3W



1080lm



Ø 74



9 002759 328825



PAGE
SEITE
PAGE

34



LED

96669 FUEVA-C

H 40, Ø 225

surface-mounted luminaire; cast metal, white / plastic, white
Aufbauleuchte; Metallguss, weiss / Kunststoff, weiss
luminaire en saillie; fonte métallique, blanc / plastique, blanc



15,6W



2000lm



9 002759 966690



PAGE
SEITE
PAGE

34



LED

96671 FUEVA-C

H 40, Ø 300

surface-mounted luminaire; cast metal, white / plastic, white
Aufbauleuchte; Metallguss, weiss / Kunststoff, weiss
luminaire en saillie; fonte métallique, blanc / plastique, blanc



21W



2700lm



9 002759 966713



smooth dimming via remote control or app / stufenlos dimmbar über Fernbedienung oder App / Graduation continue par télécommande ou l'application

PAGE
SEITE
PAGE

35

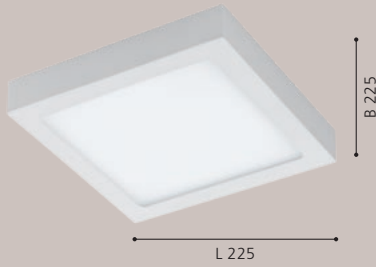

96672 FUEVA-C

L 225, B 225, H 40

surface-mounted luminaire; cast metal, white / plastic, white
Aufbauleuchte; Metallguss, weiss / Kunststoff, weiss
luminaire en saillie; fonte métallique, blanc / plastique, blanc

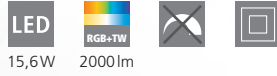

15,6W 2000lm



PAGE
SEITE
PAGE

35

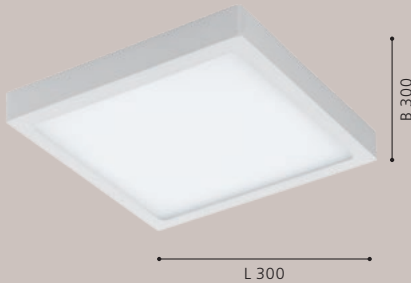

96673 FUEVA-C

L 300, B 300, H 40

surface-mounted luminaire; cast metal, white / plastic, white
Aufbauleuchte; Metallguss, weiss / Kunststoff, weiss
luminaire en saillie; fonte métallique, blanc / plastique, blanc



21W 2700lm



PAGE
SEITE
PAGE

36



96677 FUEVA-C

H 40, Ø 225

surface-mounted luminaire; cast metal, satin nickel / plastic, white
Aufbauleuchte; Metallguss, nickel-matt / Kunststoff, weiss
luminaire en saillie; fonte métallique, nickel mat / plastique, blanc



15,6W 2000lm



PAGE
SEITE
PAGE

36



96678 FUEVA-C

H 40, Ø 300

surface-mounted luminaire; cast metal, satin nickel / plastic, white
Aufbauleuchte; Metallguss, nickel-matt / Kunststoff, weiss
luminaire en saillie; fonte métallique, nickel mat / plastique, blanc

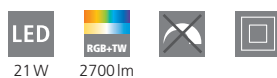

21W 2700lm



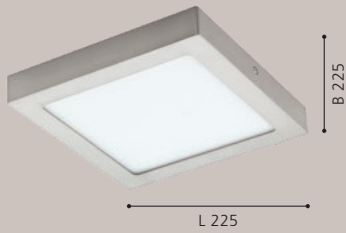

LED

96679 FUEVA-C

L 225, B 225, H 40

surface-mounted luminaire; cast metal, satin nickel / plastic, white
Aufbauleuchte; Metallguss, nickel-matt / Kunststoff, weiss
luminaire en saillie; fonte métallique, nickel mat / plastique, blanc



15,6W 2000lm



9 002759 966799

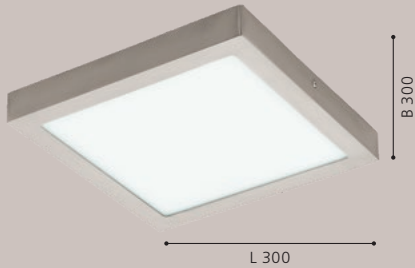

LED

96681 FUEVA-C

L 300, B 300, H 40

surface-mounted luminaire; cast metal, satin nickel / plastic, white
Aufbauleuchte; Metallguss, nickel-matt / Kunststoff, weiss
luminaire en saillie; fonte métallique, nickel mat / plastique, blanc



21W 2700lm



9 002759 966812

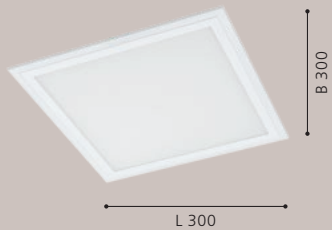

LED

96662 SALOBRENA-C

L 300, B 300, H 50

grid luminaire; aluminium, white / plastic, white
Rasterleuchte; Alu, weiss / Kunststoff, weiss
luminaire à grille; aluminium, blanc / plastique, blanc



16W 2000lm



9 002759 966621



incl.

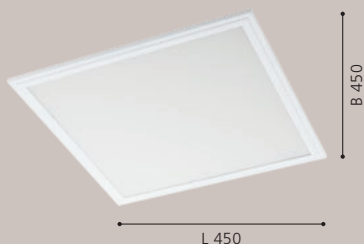

LED

97629 SALOBRENA-C

L 450, B 450, H 15

grid luminaire; aluminium, white / plastic, white
Rasterleuchte; Alu, weiss / Kunststoff, weiss
luminaire à grille; aluminium, blanc / plastique, blanc



21W 2500lm



9 002759 976293



incl.

smooth dimming via remote control or app / stufenlos dimmbar über Fernbedienung oder App / Graduation continue par télécommande ou l'application

PAGE
SEITE
PAGE

38



incl.



LED

96663 SALOBRENA-C

L 595, B 595, H 50

grid luminaire; aluminium, white / plastic, white
Rasterleuchte; Alu, weiss / Kunststoff, weiss
luminaire à grille; aluminium, blanc / plastique, blanc



34W 4300lm



9 002759 966638



PAGE
SEITE
PAGE

39



incl.



LED

96664 SALOBRENA-C

L 1200, B 300, H 50

grid luminaire; aluminium, white / plastic, white
Rasterleuchte; Alu, weiss / Kunststoff, weiss
luminaire à grille; aluminium, blanc / plastique, blanc



34W 4300lm



9 002759 966645



PAGE
SEITE
PAGE

40



incl.



LED

97958 SARSINA-C

H 50, Ø 300

ceiling luminaire; aluminium, white / plastic, white
Deckenleuchte; Alu, weiss / Kunststoff, weiss
plafonnier; aluminium, blanc / plastique, blanc



16W 2100lm



9 002759 979584



PAGE
SEITE
PAGE

40



incl.



LED

97959 SARSINA-C

H 50, Ø 450

ceiling luminaire; aluminium, white / plastic, white
Deckenleuchte; Alu, weiss / Kunststoff, weiss
plafonnier; aluminium, blanc / plastique, blanc



21W 2900lm



9 002759 979591



PAGE
SEITE
PAGE

40



incl.



Ø 600

LED

97961 SARSINA-C

H 50, Ø 600

ceiling luminaire; aluminium, white / plastic, white
Deckenleuchte; Alu, weiss / Kunststoff, weiss
plafonnier; aluminium, blanc / plastique, blanc

LED

34W

RGB+TW

4250lm



9 002759 979614



PAGE
SEITE
PAGE

41



L 5000

LED

32733 STRIPE-C

L 5000, B 12, H 3

bar / strip luminaire; plastic, white
Leuchtband/-stab; Kunststoff, weiss
bande lumineuse / bâton l; plastique, blanc

LED

19W

RGB+TW

2000lm



9 002759 327330



PAGE
SEITE
PAGE

41

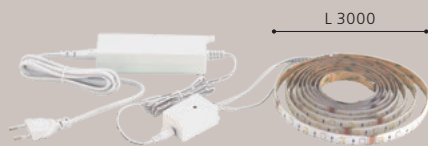

L 3000

LED

32741 STRIPE-C

L 3000, B 12, H 3

bar / strip luminaire; plastic, white
Leuchtband/-stab; Kunststoff, weiss
bande lumineuse / bâton l; plastique, blanc

LED

11,4W

RGB+TW

1200lm



9 002759 327415



PAGE
SEITE
PAGE

44



H 60

A 40



120°, 12 m
20 sec. - 10 min.

97475 CONNECT SENSOR

L 60, H 60, A 40

accessory; plastic, white
Zubehör; Kunststoff, weiss
accessoire; plastique, blanc



3x AA,
LR6



9 002759 974756

smooth dimming via remote control or app / stufenlos dimmbar über Fernbedienung oder App / Graduation continue par télécommande ou l'application

PAGE
SEITE
PAGE

46



LED

97482 CALDIERO-C

L 140, H 240, A 190

wall luminaire; zinc-plated steel, anthracite / plastic, white
Wandleuchte; Stahl verzinkt, anthrazit / Kunststoff, weiss
applique; acier galvanisé, anthracite / plastique, blanc



E27



1x 9W



1x
806lm



IP44



9 002759 974824



PAGE
SEITE
PAGE

46

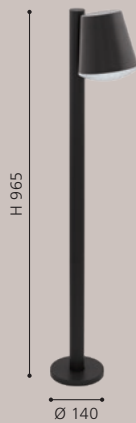

LED

97483 CALDIERO-C

L 240, B 140, H 965, Base: Ø 140

floor luminaire; zinc-plated steel, anthracite / plastic, white
Stehleuchte; Stahl verzinkt, anthrazit / Kunststoff, weiss
lampadaire; acier galvanisé, anthracite / plastique, blanc



E27



1x 9W



1x
806lm



IP44



9 002759 974831



PAGE
SEITE
PAGE

46



LED

97484 CALDIERO-C

L 140, H 240, A 190

wall luminaire; stainless steel, stainless steel / plastic, white
Wandleuchte; Edelstahl, edelstahl / Kunststoff, weiss
applique; acier inoxydable, acier inoxydable / plastique, blanc



E27



1x 9W



1x
806lm



IP44



9 002759 974848



PAGE
SEITE
PAGE

47

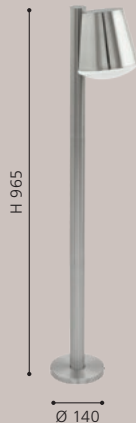

LED

97485 CALDIERO-C

L 240, B 140, H 965, Base: Ø 140

floor luminaire; stainless steel, stainless steel / plastic, white
Stehleuchte; Edelstahl, edelstahl / Kunststoff, weiss
lampadaire; acier inoxydable, acier inoxydable / plastique, blanc



E27



1x 9W



1x
806lm



IP44



9 002759 974855





LED

97247 NISIA-C**L 200, H 315, A 220**

wall luminaire; stainless steel, stainless steel / plastic, white
Wandleuchte; Edelstahl, edelstahl / Kunststoff, weiss
applique; acier inoxydable, acier inoxydable / plastique, blanc



E27



1x 9W

1x
806lm

IP44



9 002759 972479



LED

97248 NISIA-C**H 525, Ø 200, Base: Ø 140**

pedestal luminaire; stainless steel, stainless steel / plastic, white
Sockelleuchte; Edelstahl, edelstahl / Kunststoff, weiss
luminaire pour socle; acier inoxydable, acier inoxydable / plastique, blanc



E27



1x 9W

1x
806lm

IP44



9 002759 972486



LED

97249 NISIA-C**H 980, Ø 200, Base: Ø 140**

floor luminaire; stainless steel, stainless steel / plastic, white
Stehleuchte; Edelstahl, edelstahl / Kunststoff, weiss
lampadaire; acier inoxydable, acier inoxydable / plastique, blanc



E27



1x 9W

1x
806lm

IP44



9 002759 972493

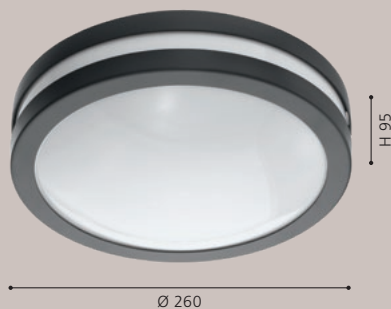

LED

97237 LOCANA-C**H 95, Ø 260**

wall / ceiling luminaire; zinc-plated steel, anthracite / plastic, white
Wand- / Deckenleuchte; Stahl verzinkt, anthrazit / Kunststoff, weiss
applique / plafonnier; acier galvanisé, anthracite / plastique, blanc



14W



1400lm



IP44



9 002759 972370



PAGE
SEITE
PAGE

49

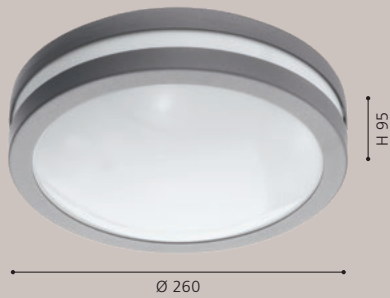

LED

97299 LOCANA-C

H 95, Ø 260

wall / ceiling luminaire; zinc-plated steel, silver / plastic, white
Wand- / Deckenleuchte; Stahl verzinkt, silber / Kunststoff, weiss
applique / plafonnier; acier galvanisé, argent / plastique, blanc



14W



1400lm



IP44



9 002759 972998

A+

PAGE
SEITE
PAGE

49



LED

97295 PIOVE-C

L 250, H 250, A 80

wall / ceiling luminaire; cast aluminium, black / plastic, white
Wand- / Deckenleuchte; Aluguss, schwarz / Kunststoff, weiss
applique / plafonnier; fonte d'aluminium, noir / plastique, blanc



14W



1400lm



IP44



9 002759 972950

A+

PAGE
SEITE
PAGE

50



LED

97239 VERRES-C

L 180, H 290, A 90

wall luminaire; stainless steel, plastic, stainless steel, white / plastic, white
Wandleuchte; Edelstahl, Kunststoff, edelstahl, weiss / Kunststoff, weiss
applique; acier inoxydable, plastique, acier inoxydable, blanc / plastique, blanc



E27



1x 9W



1x

806lm



IP44



9 002759 972394



A+

PAGE
SEITE
PAGE

50

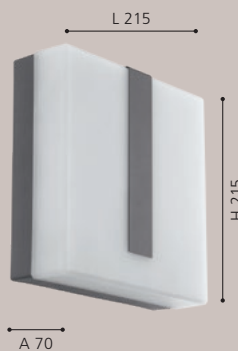

LED

97219 TORAZZA-C

L 215, H 215, A 70

wall luminaire; plastic, steel, anthracite / plastic, satin
Wandleuchte; Kunststoff, Stahl, anthrazit / Kunststoff, satiniert
applique; plastique, acier, anthracite / plastique, satiné



14W



1400lm



IP44



9 002759 972196

A+

**98105 MONTEROLO-C****H 300, Ø 300, Base: Ø 120**

floor luminaire; plastic, white / plastic, white
 Stehleuchte; Kunststoff, weiss / Kunststoff, weiss
 lampadaire; plastique, blanc / plastique, blanc



E27



1x 9W

1x
806lm

2000



IP65



9 002759 981051

**98106 MONTEROLO-C****H 390, Ø 390, Base: Ø 195**

floor luminaire; plastic, white / plastic, white
 Stehleuchte; Kunststoff, weiss / Kunststoff, weiss
 lampadaire; plastique, blanc / plastique, blanc



E27



1x 9W

1x
806lm

2000



IP65



9 002759 981068

**98107 MONTEROLO-C****H 500, Ø 500, Base: Ø 195**

floor luminaire; plastic, white / plastic, white
 Stehleuchte; Kunststoff, weiss / Kunststoff, weiss
 lampadaire; plastique, blanc / plastique, blanc



E27



1x 9W

1x
806lm

2000



IP65



9 002759 981075

**98108 MONTEROLO-C****H 600, Ø 600, Base: Ø 195**

floor luminaire; plastic, white / plastic, white
 Stehleuchte; Kunststoff, weiss / Kunststoff, weiss
 lampadaire; plastique, blanc / plastique, blanc



E27



1x 9W

1x
806lm

2000



IP65



9 002759 981082





97446 VERLUCCA-C

L 210, H 265, A 245

wall luminaire; zinc-plated steel, black / glass, clear, black
Wandleuchte; Stahl verzinkt, schwarz / Glas, klar, schwarz
applique; acier galvanisé, noir / verre, clair, noir

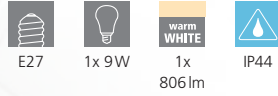

97447 VERLUCCA-C

H 990, Ø 210, Base: Ø 140

floor luminaire; zinc-plated steel, black / glass, clear, black
Stehleuchte; Stahl verzinkt, schwarz / Glas, klar, schwarz
lampadaire; acier galvanisé, noir / verre, clair, noir

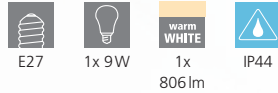

11585 EGLO CONNECT

L 116, Ø 60

illuminant
Leuchtmittel
ampoule



incl.



11586 EGLO CONNECT

L 116, Ø 60

illuminant
Leuchtmittel
ampoule





11659 EGLO CONNECT

L 136, Ø 95

illuminant
Leuchtmittel
ampoule



E27



1x 13 W



2700-
6500 K



25000h



220-240V,
50/60Hz



15000x



>80



9 002759 116590



11684 LM_LED_E27

L 118, Ø 60

illuminant
Leuchtmittel
ampoule



E27



1x 9 W



3000K



25000h



220-240V,
50/60Hz



15000x



>80



9 002759 116842



11671 LM_LED_GU10

L 68, Ø 50

illuminant
Leuchtmittel
ampoule



GU10



1x 5 W



2700-
6500 K



25000h



220-240V,
50/60Hz



15000x



>80



9 002759 116712



11672 LM_LED_E14

L 90, Ø 50

illuminant
Leuchtmittel
ampoule



E14



1x 5 W



2700-
6500 K



25000h



220-240V,
50/60Hz



15000x



>80



9 002759 116729





LEGEND & REGISTER

ERKLÄRUNG & REGISTER
LÉGENDE & REGISTRE

ENERGY EFFICIENCY LABELS

ENERGIEEFFIZIENZ-LABEL

LABEL DE L'EFFICACITÉ ÉNERGÉTIQUE

LED LEUCHTMITTEL - sind am Vormarsch, der Ruf nach energieeffizienten Lösungen wird immer größer. In den letzten Jahren wurden daher mehrere EU-Verordnungen verabschiedet, die die Kennzeichnung der Energieeffizienz bei Leuchtmitteln und Leuchten vorschreibt. Hier finden Sie eine kurze Übersicht der neuen Energieeffizienzkenzeichnung.

LES ÉCLAIRAGES LED - gagnent du terrain, la demande de solutions efficaces en énergie ne cesse de croître. C'est la raison pour laquelle plusieurs directives européennes prescrivant le marquage de l'efficacité énergétique des moyens d'éclairage et des lampes ont été promulguées au cours de ces dernières années. Vous trouverez ici un bref aperçu d'ensemble des nouveaux marquages de l'efficacité énergétique.

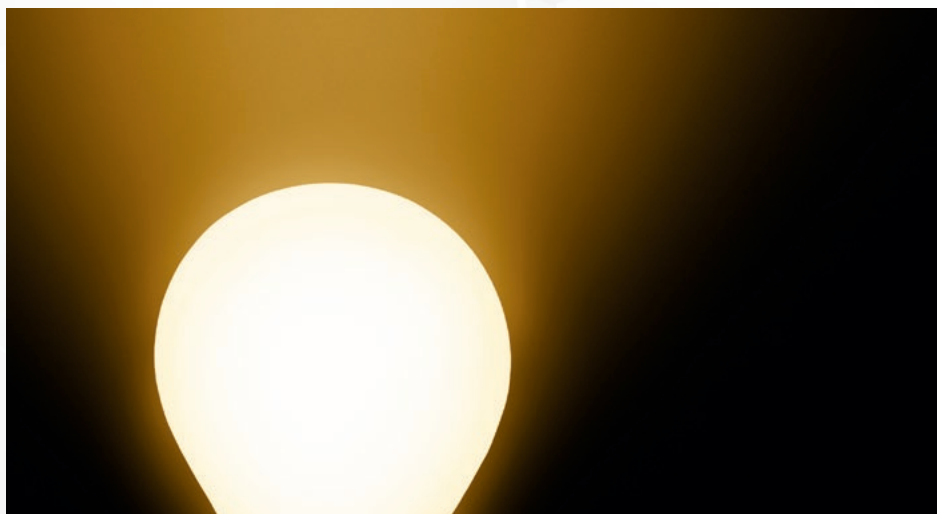

LED LUMINAIRES - are increasingly popular and the demand for energy-efficient solutions is gaining strength. This has resulted in the adoption of several EU regulations prescribing the energy efficiency labelling of light sources and luminaires. We have prepared a brief overview of the new energy labels.

EEL BUTTONS

bulbs included

inkl. Leuchtmittel | ampoules comprises



incl. highly efficient LED boards
(cannot be replaced by the end consumer)

inkl. hocheffizienter LED Platinen
(können nicht vom Endkonsumenten ausgetauscht werden)

incl. platines LED très efficaces (ne peuvent pas être remplacés par le consommateur final)



incl. highly efficient LED bulbs

inkl. hocheffizienter LED Leuchtmittel
ampoules à LED plus efficaces comprises



incl. efficient LED and/or fluorescent bulbs

inkl. effizienter LED und/oder Leuchtstoff-Leuchtmittel

ampoules à LED et/ou fluorescentes efficaces comprises



incl. halogen bulbs

inkl. Halogen-Leuchtmittel

ampoules halogènes comprises

bulbs not included

exkl. Leuchtmittel | ampoules non comprises



The luminaire is compatible with bulbs of all energy classes.

Die Leuchte ist mit Leuchtmitteln aller Energieklassen kompatibel.

compatible avec des ampoules de toutes les classes de l'énergie



The luminaire is only compatible with energy efficient bulbs.

Die Leuchte ist nur mit energieeffizienten Leuchtmitteln kompatibel.

compatible uniquement avec des ampoules économes en énergie

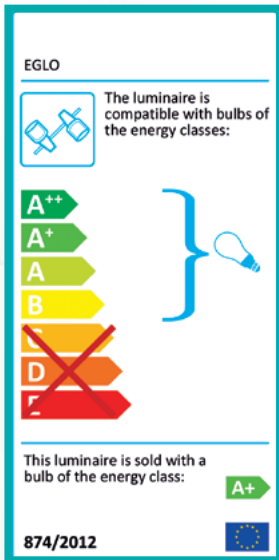

The information in brackets at the centre of the label indicates which bulbs may be used for the luminaire. In this case, the product is only compatible with bulbs with an energy efficiency rating of better than C.

Die Klammer in der Mitte des Labels gibt an, mit welchen Leuchtmitteln die Leuchte kompatibel ist. In diesem Fall dürfen nur Leuchtmittel verwendet werden, deren Energieklasse effizienter als C ist.

La parenthèse au milieu du label indique les moyens d'éclairage avec lesquels la lampe est compatible. Il est seulement permis dans ce cas d'utiliser des moyens d'éclairage dont la classe d'énergie présente une efficacité supérieure à C.

If bulbs are included with the luminaire, their energy classes are indicated at the bottom of the label.

Falls Leuchtmittel inkludiert sind, wird deren Energieklasse im unteren Teil des Labels angegeben.

Si des moyens d'éclairage sont inclus, leur classe énergétique est indiquée dans la partie inférieure du label.

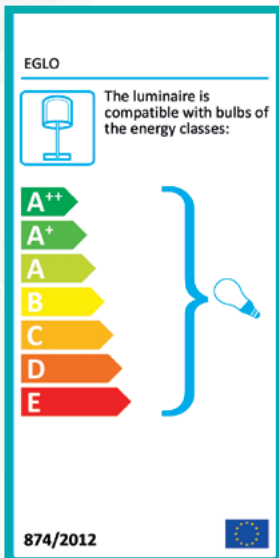

This label indicates that no bulbs are included with the luminaire. Consumers are free to choose their preferred bulb within the indicated energy classes.

Dieses Label wird verwendet, wenn die Leuchte ohne Leuchtmittel ausgeliefert wird. Der Kunde kann selber entscheiden, welches Leuchtmittel der angegebenen Klassen verwendet wird.

Ce label est utilisé lorsque la lampe est livrée sans ampoules. Le client peut décider lui-même quel ampoule des classes indiquées est utilisé.

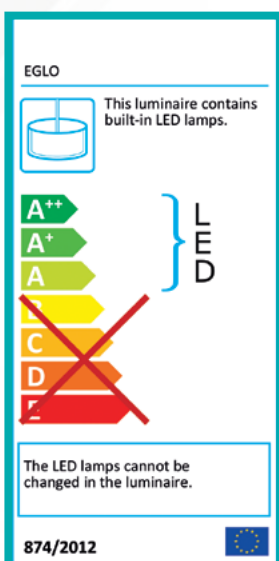

This label indicates that the luminaire is sold with built-in LED lamps that cannot be replaced by the consumer himself.

Dieses Label wird verwendet, wenn Leuchten mit LED-Modulen verkauft werden, die vom Endkunden nicht selbstständig ausgetauscht werden können.

Ce label est utilisé lorsque des lampes sont vendues avec des modules LED ne pouvant pas être changés par les clients finaux eux-mêmes.

EGLO WORLDWIDE

EGLO WELTWEIT

EGLO DANS LE MONDE



 **HEADQUARTERS**
EGLO LEUCHTEN GMBH
Heiligkreuz 22
A-6136 PILL
T: +43 5242 6996 0 | F: +43 5242 6996 972
E: info-austria@eglo.com

 **CANADA**
EGLO CANADA INC.
20700 Route Transcanadienne
Baie D'Urfé, Québec | H9X 4B7
T: +1 514 457 5483 | F: +1 514 457 5487
E: info-canada@eglo.com

 **CROATIA**
EGLO RASVJETA D.O.O.
Josipa Loncara 3
HR-10000 ZAGREB
T: +385 1 379 40 62 | F: +385 1 379 41 04
E: info-croatia@eglo.com

 **AUSTRALIA**
EGLO LIGHTING AUSTRALIA
5/339 Archerfield Road
Richlands | Queensland 4077
T: +61 7 3375 1413 | F: +61 7 3375 1412
E: info@eglolighting.com.au

 **CHILE - IQUIQUE**
EGLO CHILE ILUMINACION LTDA.
Manzana 10 | Galpón 5 | Recinto
Amurallado | Zona Franca Iquique - CHILE
T: +56 57 2 4174 72 | F: +56 57 2 4174 69
E: info-chile@eglo.com

 **CZECH REPUBLIC**
EGLO CZ+SK s.r.o.
Náchodská 2479/63
CZ-193 00 PRAHA 9 Horní Počernice
T: +420 281 924 163 | F: +420 281 925 205
E: info-czechrepublic@eglo.com

 **BELGIUM**
EGLO BELGIUM B.V.B.A.
Antwerpsesteenweg 247 | B-2950 Kapellen
Visit Address: Innovatiepark 20 |
4906 AA OOSTERHOUT (NL)
T: +32 3 250 60 80 | F: +32 3 219 80 67
E: info-belgium@eglo.com

 **CHILE - SANTIAGO**
EGLO CHILE ILUMINACION LTDA.
Av. Américo Vespucio 1930
Conchalí - SANTIAGO DE CHILE
T: +562 2 595 2222
E: info-chile@eglo.com

 **DENMARK**
EGLO DANMARK A/S
Agerbakken 20
DK-8362 Hørring
T: +45 70 22 55 11 | F: +45 70 22 55 21
E: info-denmark@eglo.com

 **BOSNIA-HERZEGOVINA**
EGLO RASVJETA BH D.O.O.
Ormanica bb
BIH-76250 GRADACAC
T: +387 35 86 85 00 | F: +387 35 82 44 41
E: gradacac@eglo.ba

 **CHINA**
DONGGUAN EGLO LIGHTING COMMERCIAL CO LTD
No. 1 | Shangqiao Industrial Road | Shangqiao,
Dongcheng District
DONGGUAN CITY, GUANZHOU PROVINCE | CHINA
T: +86 769 2203 3866 | F: +86 769 2203 6866
E: info-china@eglo.com

 **ESTONIA**
MOODNE VALGUSTUS AS
Rävala pst. 7
EE-10143 TALLINN
T: +372 667 6670 | F: +372 631 3195
E: info-estonia@eglo.com

 **BRAZIL**
EGLO DO BRASIL LUMINÁRIAS LTDA.
Villa Lobos Office Park | Av. Queiroz Filho, 1700.
Vila Hamburguesa - São Paulo - SP |
Torre D Sala 1 | CEP: 05319-000
T: +55 11 4193 6980 | F: +55 11 2337-3921
E: sac@eglo.com.br

 **COLUMBIA**
EGLO Kolumbien
AUTOPISTA NORTE KM 19 COSTADO LOTE 30
BOGOTÁ - CHIA
T: +57 (1) 744 2339
E: contacto@eglo.com.co

 **FINLAND**
EGLO FINLAND OY
Malmniraitti 17A
00700 Helsinki
T: +358 20 7649 820 | F: +358 20 7649 821
E: info-finland@eglo.com

 **BULGARIA**
EGLO BULGARIA EOOD
2B 'Serdika' Str.
8000 BOURGAS
T: +359 56 960 403 | F: +359 56 53 05 95
E: info-bulgaria@eglo.com

 **COSTA RICA**
EGLO Costa Rica, Centro Comercial Calle Real local #8
Guachipilín de Escazú de la sucursal del BAC
San Jose 800 metros al norte San Jose Costa Rica.
T: +506-88464949
E: info-costarica@eglo.com

 **FRANCE**
EGLO FRANCE LUMINAIRE SARL
Z.A. Jeune Bois | 2 Rue de la Martinique
F-68274 WITTENHEIM
T: +33 389 6250 30 | F: +33 389 6250 49
E: info-france@eglo.com

 GERMANY
EGLO LEUCHTEN HANDELS GMBH
Kleinbahnstr. 35
D-59759 ARNSBERG
T: +49 2932 6269 0 | F: +49 2932 6269 39
E: info-germany@eglo.com

 GREECE
EGLO HELLAS A.E.
Sykias 2 and parodos dekeleias
ACHARNAI, GR-13679
T: +30 210 240 77 10 | F: +30 210 240 07 29
E: info-greece@eglo.com

 GREAT BRITAIN
EGLO UK LTD.
Unit 12 Cirrus Park, Lower Farm Road, Moulton Park
Industrial Estate, NORTHAMPTON NN3 6UR
T: +44 1604 790 986 | F: +44 1604 670 282
E: info-greatbritain@eglo.com

 HUNGARY - PRODUCTION & LOGISTICS
EGLO MAGYARORSZAG KFT.
Fő út. 155
H-3060 PASZTO
T: + 36 32 560 050 | F: +36 32 560 040
E: info-hungary@eglo.com

 INDIA
EGLO INDIA PRIVATE LIMITED
A-307 Ansal Chamber-1, 3 Bhikaji Cama Place,
New Delhi-110066
T: +91 981 108 2205 | F: +91 999 961 0450
E: info-india@eglo.com

 ITALY
EGLO ITALIANA S.R.L.
Via Giotto, 4
I-31021 MOGLIANO VENETO (TV)
T: +39 041 45 66 232/245/251 | F: +39 041 45 74 066/071
E: info-italy@eglo.com

 KAZAKHSTAN
EGLO KAZAKHSTAN LLP
Office 300, Floor 24, Block 5A, Nurly-Tau Business Centr,
Al-Farabi Avenue 7, 050059, Almaty Kazakhstan
T: +7 727 293 25 20 | M: +7 701 727 6000
E: info-kazakhstan@eglo.com

 KOSOVO
EGLO KOSOVA LLC
Lugisht e qytetit pn
20000 PRIZREN- KOSOVO
T: +377 44 2166 87 | Shop: +381 29 2442 84
E: info-kosovo@eglo.com

 LEBANON
EGLO Lebanon S.A.R.L
Damascus Street, Graizy Building - Basement No. 1
Aley city, Lebanon
T: +961 555 9125 | T: +961 555 9126
E: info@eglo-lb.com

 LITHUANIA
MOODNE VALGUSTUS AS
Rāvala pst. 7
EE-10143 TALLINN
T: +370 652 49923 | T: +372 667 6670
E: info-lithuania@eglo.com

 MAGYARORSZÁG – ÉRTÉKESÍTÉS
EGLO LUX KFT.
Fő út. 143/A
H-2120 DUNAKESZI
T: +36 27 341 353 | F: +36 27 341 409
E: info-hungary@eglo.com

 MALAYSIA
EGLO ASIA SDN BHD
1.07, level 1, Wisma Academy, Lot 4A, Jalan 19/1,
46300 Petaling Jaya. Selangor Darul Ehsan, Malaysia
T: +603 7956 5277 | F: +603 7931 6277
E: info-malaysia@eglo.com

 MEXICO
EGLO MÉXICO ILUMINACIÓN S DE RL DE CV
Prolongación Av. López Mateos Sur N°3561, Fracc.
Los Gavilanes. C.P. 45645, Tlajomulco de Zúñiga,
Jalisco. México
T: +52 33 3687 20 95 | E: info-mexico@eglo.com

 MIDDLE EAST
EGLO LIGHTING MIDDLE EAST FZE
P.O. BOX 262073, LOB 6, OFFICE G18
JEBEL ALI, DUBAI, UAE
T: +97 148810080 | F: +97 148810081
E: info.me@eglo.com

 MOROCCO
EGLO MAGHREB LUMINAIRES SARL
219 Bd Med Zerkouni. Suite: 67
20330 CASABLANCA | Morocco
T: +212 598 8005 | F: +212 525 6167
E: info-maghreb@eglo.com

 THE NETHERLANDS
EGLO VERLICHTING NEDERLAND B.V.
Innovatiepark 20
4906 AA OOSTERHOUT (NBR)
T: +31 162 48 28 30 | F: +31 162 48 28 40
E: info-nl@eglo.com

 NORWAY
ELEKTRO-ARMATUR a.s
Björnerudveien 18
N-1266 OSLO
T: +47 2262 9000 | F: +47 2262 9040
E: post@ea.no

 PERU
EGLO PERU S.A.C
Avda. Santa Cruz No. 458
San Isidro - Lima
T: +51 1 4212 158
E: info-peru@eglo.com

 PHILIPPINES
EGLO Lighting Pilipinas Corp.
4/F One E-Com Center Building, Ocean Drive, Mall
of Asia Complex, Pasay City 1300 Philippines
T: +63 2 737 9419
E: eglo.philippines@eglo.com

 POLAND
EGLO POLSKA SP. Z.O.O.
Ul. Pulawska 479
02-844 WARSZAWA
T: +48 22 644 57 55 | F: +48 22 644 89 82
E: info-poland@eglo.com

 PORTUGAL
EGLO PORTUGAL ILUMINAÇÃO, LDA
Rua Fonte Parada, 125
PT-4595-434 SEROA-PAÇOS DE FERREIRA
T: +351 255 890 000 | F: +351 255 892 346
E: info-portugal@eglo.com

 ROMANIA
EGLO ROMANIA PRODEXIM SRL.
Str. Atomistilor nr. 1D
R-077125 MASURELE - ILFOV - ROMANIA
T: +40 314 250 902 | F: +40 314 250 899
E: info-romania@eglo.com

 RUSSIA
EGLO LIGHTING LLC
Varshavskoe shosse 35 | Building 1
RU-117105 | MOSCOW
T: +7495 789 4311 | F: +7495 789 4312
E: info-russia@eglo.com

 SERBIA
EGLO RASVETA DOO
Stefana Prvovenčanog 28
11000 BEOGRAD | SRBIJA
T: +381 11 3981 366 | F: +381 11 3981 389
E: info-serbia@eglo.com

 SLOVAKIA
EGLO CZ+SK s.r.o
Náhodská 2479/63
CZ-193 00 PRAHA 9 Homí Pocerne
T: +421 313 211 551 | F: +421 313 211 556
E: info-slovakia@eglo.com

 SLOVENIA
EGLO RASVJETA D.O.O.
Josipa Loncara 3
HR-10000 ZAGREB
T: +386 158 093 18
E: info-slovenia@eglo.com

 SPAIN
EGLO ESPANA ILUMINACION S.L.
Avda. de Castilla 1 (Edf. Best Point) 2°-16A
San Fernando de Henares, E-28830 MADRID
T: +34 91 677 9044 | F: +34 91 677 0304
E: info-spain@eglo.com

 SWEDEN
EGLO SVERIGE AB
Honungsgatan 3
S-432 48 VARBERG
T: +46 340 623 505 | F: +46 340 623 605
E: info-sweden@eglo.com

 SWITZERLAND
EGLO SCHWEIZ AG
Seetalstraße 142
CH-6032 EMMEN
T: +41 41 268 69 59 | F: +41 41 268 69 58
E: info-switzerland@eglo.com

 TURKEY
Eglo Aydınlatma ithalat ihracat Ltd. Şti.
Eyüp Sultan Mah. Sekmen Cad. No:18/2
34855 SAMANDIRA, SANCaktepe / İSTANBUL
T: +90 216 311 09 -02 / -03 / -04 | F: +90 216 311 09 -05
E: info-turkey@eglo.com



















 USA
EGLO USA, INC.
3640 Royal South Parkway
ATLANTA, GEORGIA 30349
T: +1 404 477 5601 | F: +1 404 393 7053
E: info-usa@eglo.com

 UKRAINE
EGLO UKRAINE LTD
bulv. Vatslav Havel 6/7A
UA-03680 KIEV
T: +38 044 463 98 41 | F: +38 044 468 84 67
E: info-ukraina@eglo.com



















































LEGEND

PICTOGRAM PIKTOGRAMME PICTOGRAMME

SOCKETS FASSUNGEN DOUILLES

 LED	 G4	 G53
 2G7	 G5	 GU5,3 / MR16
 2G11	 G9	 GU10
 2GX13	 G10Q	 GX53
 E14	 G13	 GY6,35
 E27	 G23	 R7s

BULBS LEUCHTMITTEL AMPOULES

 E14 / C35	 E27 / G90	 E27 / T30 Filament
 E14 / C35f	 E27 / QR63	 E27 / T32 Filament
 E14 / D45	 E27 / A60 Halogen	 G4 / T9
 E14 / C35f LED	 E27 / R63 Halogen	 G4 / LT9
 E14 / D45 Halogen	 E27 / A60 LED	 G4 / LT14
 E14 / C35 Halogen	 E27 / A60 Filament	 G9
 E14 / T22	 E27 / A65 LED	 G9 LED
 E14 / C35 Filament	 E27 / A75 Filament	 GU10
 E14 / C37 Filament	 E27 / G45 LED	 GU10 LED
 E14 / C35f Filament	 E27 / G45 Filament	 GU10 SMD LED
 E14 / C37f Filament	 E27 / G80 Filament	 GX53 / LF75
 E14 / P45 LED	 E27 / G95	LED LED board / LED Platine / LED bord
 E14 / P45 Filament	 E27 / G95 Filament	 MR16
 E14 / P50	 E27 / G125	 MR16 LED
 E14 / ST48 Filament	 E27 / G95 LED	 R7s / 78mm
 E14 / ST64 Filament	 E27 / R63 LED	 R7s / 118mm
 E14 / T20 LED	 E27 / ST48 Filament	
 E27 / A60	 E27 / ST64 Filament	

LIGHT COLOUR & LUMEN
LICHTFARBE & LUMEN
COULEUR LUMINEUX & LUMEN

The colours of the LED are represented as pictogrammes (see below), their luminous flux directly beneath. The luminous flux is quoted in lumen and describes the amount of light generated by the LED. The higher the value, the brighter is the lamp. Lumens are LED boards and are the light measurement value in bulbs.

Die Farben der LED werden als Piktogramm (siehe unten) dargestellt, deren Lichtstrom direkt darunter. Der Lichtstrom wird in Lumen gemessen und gibt die erzeugte Lichtmenge der LED an. Je höher der Wert, desto heller das Produkt. Lichtstromangaben (Lumen) sind Platinen- bzw. Leuchtmittelwerte.

Les couleurs de LED ont représentés sous forme de pictogrammes, leur flux lumineux directement en dessous. L'unité de flux lumineux est le lumen et il mesure la quantité de lumière générée par les LED. Plus la valeur est élevée, plus la lampe est lumineuse. Les lumens sont l'unité de mesure de l'intensité lumineuse des ampoules et des panneaux led intégrés.

	RGB RGB RGB		RGB + tunabel white RGB + tunabel white RGB + tunabel white
	RGB + white RGB + weiß RGB + blanc		tunable white tunable white tunable white
	RGB + warmwhite RGB + warmweiß RGB + blanc chaud		warm white warmweiß blanc chaud
	RGB + coldwhite RGB + kaltweiß RGB + blanc froid		cold white kaltweiß blanc froid
	RGB + neutralwhite RGB + neutralweiß RGB + blanc neutral		neutral white neutralweiß blanc neutre

SWITCHES & SENSORES
SCHALTER & SENSOREN
INTERRUPTEUR & CAPTEURS

	incl. cable & plug inkl. Kabel & Stecker câble & connecteur inclus		pedal switch Trittschalter interrupteur à pied		swedish plug Stecker Schweden connecteur swede
	internal dimmer eingebauter Dimmer variateur intégré		cable switch Kabelschalter interrupteur à câble		"Touch me" ON/OFF "Touch me" EIN/AUS "Touch me" ON/OFF
	button switch Druckknopf interrupteur de pression		incl. cable & plug transformer inkl. Kabel & Stecktransformator câble & transformateur à prise		"Touch me" ON/OFF & dimm "Touch me" EIN/AUS & Dimmen "Touch me" ON/OFF & graduable
	function switch Funktionsschalter interrupteur fonction		remote control Fernbedienung télécommande		pull switch Zugschalter interrupteur à bascule
	rocker switch Wippschalter interrupteur à bascule		Day & Night Sensor Tag & Nacht Sensor sensor jour & nuit		Timer - automatic on/off Zeitschaltuhr - automatisches Ein- & Ausschalten minuterie - peut être éteint et allumé automatiquement
	pedal dimmer Trittdimmer variateur à pied		sensor Sensor sensor		

FUNKTIONEN & COMFORT
FUNKTIONEN & KOMFORT
FONCTIONS & CONFORT

	incl. battery inkl. Akku incl. pile		cutout (in mm) Ausschnitt (in mm) perçage du panneau (en mm)		shortable kürzbar réductible
	incl. battery inkl. Batterie incl. pile		dimmable dimmar graduable		Voltage Volt Voltage
	battery specifications Batteriespezifikationen spécifications des piles		not dimmable nicht dimmbar ne pas graduable		Watt
	beam angle Ausstrahlwinkel angle de rayonnement		replaceable LED austauschbare LED LED remplaçables		
	corner mount possible Eckmontage möglich montage en coin possible		loadable in kg belastbar in kg chargeable en kg		
	Colour Rendering Index		packaging / delivery unit Verpackungs- / Liefereinheit unité d'emballage / de livraison		

PROTECTION CLASS
SCHUTZKLASSE
CLASSE DE PROTECTION

The protection class indicates to what extent the lamp is protected against electric shock. All lamps in this catalogue are at least protected with the protection class 1 - a higher class is specified in the information box of the respective lamp.

Die Schutzklasse gibt an, inwiefern ein Produkt gegen einen elektrischen Schlag gesichert ist. Alle Leuchten in diesem Katalog sind mit mindestens Schutzklasse 1 gesichert, bei höheren Klassen wird das Symbol im Infokasten der Leuchte angegeben.

La classe de protection indique, dans quelle mesure la lampe est protégée contre les chocs électriques. Tous les lampes dans ce catalogue sont protégées au moins avec la classe 1 - une classe plus élevée est indiquée dans l'information de la lampe.

	protection class 1: protective earthing Schutzklasse 1: Schutzerdung classe de protection 1: prise de terre		protection class 2: protective insulation Schutzklasse 2: Schutzisolierung classe de protection 2: double isolation ou renforcée		protection class 3: protective low voltage Schutzklasse 3: Schutzkleinspannung classe de protection 3: très basse tension de sécurité
--	---	--	--	--	---

PROTECTION RATING
SCHUTZGRAD
INDICE DE PROTECTION

The protection rating ensures the operational safety of luminaires. The first number specifies the extent of the protection against the ingress of foreign bodies; the second number identifies the humidity protection grade. All luminaires in this catalogue are at least protected with the rating IP20 - a higher rating is specified in the information box of the luminaire.

Der Schutzgrad gewährleistet die Betriebssicherheit von Leuchten. Die erste Ziffer des IP Grades beschreibt den Schutzzumfang gegen das Eindringen von Fremdkörpern, die zweite Ziffer informiert über den Grad des Feuchtigkeitsschutzes. Alle Leuchten in diesem Katalog sind mit mindestens Schutzgrad IP20 gesichert, bei höheren Graden wird das Symbol im Infokasten der Leuchte angegeben.

L'indice de protection assure la sécurité opérationnelle des luminaires. Le premier chiffre indique à quel point la protection est efficace contre l'insertion de corps étrangers; le second chiffre indique quant à lui le degré de protection par rapport à l'humidité. Tous les luminaires dans ce catalogue sont protégés au moins avec l'indice IP20 - un indice plus élevé est indiqué dans l'information d'article.

	IP33		IP44		IP54		IP65		IP67
--	------	--	------	--	------	--	------	--	------

LEGEND

ROW LAYOUT
REIHEN LAYOUT
LIGNE DE MISE EN PAGE

DESCRIPTION BESCHREIBUNG DESCRIPTION

The product description is composed as follows:
luminaire type; enclosure material, enclosure colour / glass or shade material, glass or shade colour

Die Produktbeschreibung setzt sich wie folgt zusammen:
Leuchtenart; Gehäusematerial, Gehäusefarbe / Schirm- bzw. Glasmaterial, Schirm- bzw. Glasfarbe

La description du produit est composée comme suit:
type de luminaire; matériel de boîtier, couleur de boîtier / matériel de verre ou abat-jour, couleur de verre ou abat-jour

ARTICLE NUMBER ARTIKELNUMMER NUMÉRO D'ARTICLE

88

14

97907 FRAIOLI-C

L 1055, B 100, H 1200

Socket:	LED
Power:	2x 17 W
Lumen:	4600lm

pendant luminaire; aluminium, satin nickel / plastic, white
Hängeleuchte; Alu, nickel-matt / Kunststoff, weiss
luminaire en suspension; aluminium, nickel mat / plastique, blanc

97906 FRAIOLI-C

L 1055, B 120, H 65

Socket:	LED
Power:	2x 17 W
Lumen:	4600lm

ceiling luminaire; aluminium, satin nickel / plastic, white
Deckenleuchte; Alu, nickel-matt / Kunststoff, weiss
plafonnier; aluminium, nickel mat / plastique, blanc

97908 FRAIOLI-C

H 1755, Base: B 280, T 280

Socket:	LED
Power:	2x 17 W
Lumen:	4600lm

floor luminaire; aluminium, satin nickel / plastic, white
Stehleuchte; Alu, nickel-matt / Kunststoff, weiss
lampadaire; aluminium, nickel mat / plastique, blanc

smooth dimming via remote control or app / stufenlos dimmbar über Fernbedienung oder App / Graduation continue par télécommande ou l'application

EGLO connect / Indoor - Lighting Families

SERIES NAME
SERIENNAME
NOM DE LA SÉRIE

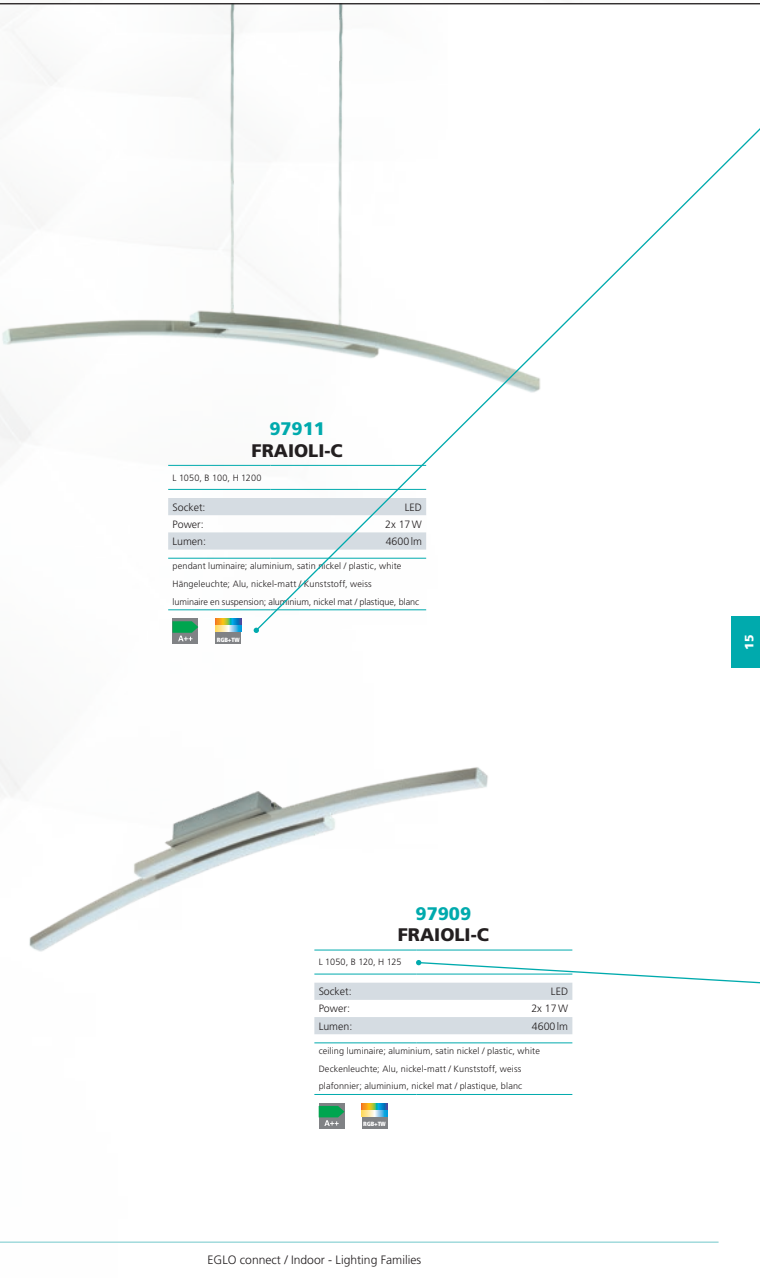

**97911
FRAIOLI-C**

L 1050, B 100, H 1200

Socket:	LED
Power:	2x 17 W
Lumen:	4600 lm

pendant luminaire, aluminium, satin nickel / plastic, white
Hängeleuchte; Alu, nickel-matt / Kunststoff, weiss
luminaire en suspension, aluminium, nickel mat / plastique, blanc



**97909
FRAIOLI-C**

L 1050, B 120, H 125

Socket:	LED
Power:	2x 17 W
Lumen:	4600 lm

ceiling luminaire, aluminium, satin nickel / plastic, white
Deckenleuchte; Alu, nickel-matt / Kunststoff, weiss
plafonnier; aluminium, nickel mat / plastique, blanc



EGLO connect / Indoor - Lighting Families

BUTTONS
BUTTONS
BOUTONS

LED Lightcolour | LED Lichtfarbe | couleur de LED

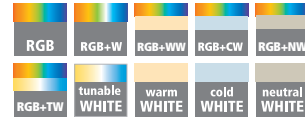

EI bulbs not included | Leuchtmittel exklusive | ampoules non comprises



EI bulbs included | Leuchtmittel inklusive | ampoules comprises

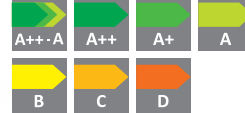

p.082-083

Colour Rendering Index | Farbwiedergabeindex | Indice de rendu de couleur de LED



Bulb included | Leuchtmittel inkludiert | ampoules inclus



DIMENSIONS
DIMENSIONEN
DIMENSIONS

all dimensions in mm | alle Größen in mm | toutes dimensions en mm

L = length | Länge | longueur

B = width | Breite | largeur

H = height | Höhe | hauteur

Ø = diameter | Durchmesser | diamètre

A = projection length | Ausladung | amplitude

ET = installation depth | Einbautiefe | profondeur utile

Base = base dimensions | Sockelmaße | dimensions de base

Attention! The dimensions relate solely to the sizes of the luminaire. Any air spaces that would be relevant for a safe operating of the lamp were not considered.

Achtung! Die Größen beziehen sich nur auf die Abmessungen der Leuchte. Etwaige Lufträume, die für einen sicheren Betrieb der Leuchte notwendig sind, werden nicht berücksichtigt.

Attention! Les dimensions se réfèrent à la taille de la lampe seulement. Espaces éventuels, que seraient importants pour une opération de la lampe sans danger, n'ont pas été considérés.

LEGEND

BOX LAYOUT

BOXEN LAYOUT

BOÎTE DE MISE EN PAGE

ARTICLE NUMBER
ARTIKELNUMMER
NUMÉRO D'ARTICLE

SERIES NAME
SERIENNAME
NOM DE LA SÉRIE

DESCRIPTION
BESCHREIBUNG
DESCRIPTION

The product description is composed as follows:
luminaire type; enclosure material, enclosure colour / glass or shade material, glass or shade colour

Die Produktbeschreibung setzt sich wie folgt zusammen:
Leuchtenart; Gehäusematerial, Gehäusefarbe / Schirm- bzw. Glasmaterial, Schirm- bzw. Glasfarbe

La description du produit est composée comme suit:
type de luminaire; matériel de boîtier, couleur de boîtier / matériel de verre ou abat-jour, couleur de verre ou abat-jour

PAGE
SEITE
PAGE

48

97247 NISIA-C

L 200, H 315, A 220

wall luminaire; stainless steel, stainless steel / plastic, white
Wandleuchte; Edelstahl, edelstahl / Kunststoff, weiss
applique; acier inoxydable, acier inoxydable / plastique, blanc

E27
 1x 9W

WHITE
 1x 806lm

IP44

9 002759 972479

PAGE
SEITE
PAGE

48

97248 NISIA-C

H 525, Ø 200, Base: Ø 140

pedestal luminaire; stainless steel, stainless steel / plastic, white
Sockelleuchte; Edelstahl, edelstahl / Kunststoff, weiss
luminaire pour socle; acier inoxydable, acier inoxydable / plastique, blanc

E27
 1x 9W

WHITE
 1x 806lm

IP44

9 002759 972486

PAGE
SEITE
PAGE

48

97249 NISIA-C

H 960, Ø 200, Base: Ø 140

floor luminaire; stainless steel, stainless steel / plastic, white
Stehleuchte; Edelstahl, edelstahl / Kunststoff, weiss
lampadaire; acier inoxydable, acier inoxydable / plastique, blanc

E27
 1x 9W

WHITE
 1x 806lm

IP44

9 002759 972493

PAGE
SEITE
PAGE

49

97237 LOCANA-C

H 95, Ø 260

wall / ceiling luminaire; zinc-plated steel, anthracite / plastic, white
Wand- / Deckenleuchte; Stahl verzinkt, anthrazit / Kunststoff, weiss
applique / plafonnier; acier galvanisé, anthracite / plastique, blanc

LED
 14W

WHITE
 1400lm

IP44

9 002759 972370

smooth dimming via remote control / or app / stufenlos dimmbar über Fernbedienung oder App / Graduation continue par télécommande ou l'application

EGLO connect / Technical / Description

PICTOGRAMMES
PIKTOGRAMME
PICTOGRAMMES

Technical details are represented as pictograms. An overview over all pictograms can be found on the next pages.
Technische Details werden als Piktogramme dargestellt. Eine Übersicht über alle Piktogramme finden Sie auf den nächsten Seiten.

Les détails techniques sont représentés sous forme de pictogrammes. Vous trouverez un aperçu de tous les pictogrammes dans les pages suivantes.



97299 LOCANA-C
H 95, Ø 260
 wall / ceiling luminaire; zinc-plated steel, silver / plastic, white
 Wand-/ Deckenleuchte; Stahl verzinkt, silber / Kunststoff, weiss
 applique / plafonnier; acier galvanisé, argent / plastique, blanc

LED 14 W
 warm WHITE 1400 lm
 IP44



97295 PIOVE-C
L 250, H 250, A 80
 wall / ceiling luminaire; cast aluminium, black / plastic, white
 Wand-/ Deckenleuchte; Aluguss, schwarz / Kunststoff, weiss
 applique / plafonnier; fonte d'aluminium, noir / plastique, blanc

LED 14 W
 warm WHITE 1400 lm
 IP44

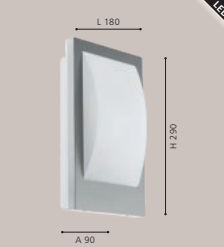

97239 VERRES-C
L 180, H 290, A 90
 wall luminaire; stainless steel, plastic, stainless steel, white / plastic, white
 Wandleuchte; Edelstahl, Kunststoff, edelstahl, weiss / Kunststoff, weiss
 applique; acier inoxydable, plastique, acier inoxydable, blanc / plastique, blanc

E27
 1x 9 W
 warm WHITE 806 lm
 IP44

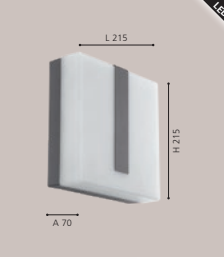

97219 TORAZZA-C
L 215, H 215, A 70
 wall luminaire; plastic, steel, anthracite / plastic, satiné
 Wandleuchte; Kunststoff, Stahl, anthrazit / Kunststoff, satiniert
 applique; plastique, acier, anthracite / plastique, satiné

LED 14 W
 warm WHITE 1400 lm
 IP44



**BUTTONS
BUTTONS
BOUTONS**

LED Lightcolour | LED Lichtfarbe | couleur de LED



EEL bulbs not included | Leuchtmittel exklusive | ampoules non comprises



EEL bulbs included | Leuchtmittel inklusive | ampoules comprises

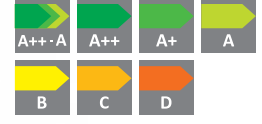

p.082-083

Colour Rendering Index | Farbwiedergabeindex | Indice de rendu de couleur de LED



Bulb included | Leuchtmittel inkludiert | ampoules inclus



**DIMENSIONS
DIMENSIONEN
DIMENSIONS**

all dimensions in mm | alle Größen in mm | toutes dimensions en mm

- L = length | Länge | longueur
- B = width | Breite | largeur
- H = height | Höhe | hauteur
- Ø = diameter | Durchmesser | diamètre
- A = projection length | Ausladung | amplitude
- ET = installation depth | Einbautiefe | profondeur utile
- Base = base dimensions | Sockelmaße | dimensions de base

Attention! The dimensions relate solely to the sizes of the luminaire. Any air spaces that would be relevant for a safe operating of the lamp were not considered.

Achtung! Die Größen beziehen sich nur auf die Abmessungen der Leuchte. Etwaige Lufträume, die für einen sicheren Betrieb der Leuchte notwendig sind, werden nicht berücksichtigt.

Attention! Les dimensions se réfèrent à la taille de la lampe seulement. Espacements éventuels, que seraient importants pour une opération de la lampe sans danger, n'ont pas été considérés.

REGISTER

SERIES NAMES
SERIENNAMEN
NOME DE PRODUITS

NAME NAME NOME	PAGE PRODUCT SEITE PRODUKT PAGE PRODUIT	PAGE TECHNIQUE SEITE TECHNIK PAGE TECHNIQUE	NAME NAME NOME	PAGE PRODUCT SEITE PRODUKT PAGE PRODUIT	PAGE TECHNIQUE SEITE TECHNIK PAGE TECHNIQUE	NAME NAME NOME	PAGE PRODUCT SEITE PRODUKT PAGE PRODUIT	PAGE TECHNIQUE SEITE TECHNIK PAGE TECHNIQUE
BERAMO-C	22	64	LM_LED_E14	58	80	TOTARI-C	24-25	65-66
CALDIERO-C	46-47	75	LM_LED_E27	58	80	VERLUCCA-C	54	79
CAPASSO-C	22	64	LM_LED_GU10	58	80	VERRES-C	50	77
COMBA-C	20	63	LOCANA-C	49	76-77	VOLTAGO-C	23	65
COMPETA-C	23	65	MONEVA-C	20	63-64			
CONNECT PLUG	12	60	MONTEROLO-C	52-53	78			
CONNECT PLUG PLUS	12	60	NISIA-C	48	76			
CONNECT SENSOR	44	74	PALOMBARE-C	28-29	67-68			
CORROPOLI-C	26-27	66-67	PIOVE-C	49	77			
EGLO CONNECT	12,57	60,79-80	RIODEVA-C	18	63			
FRAIOLI-C	14-15	60-61	SALOBRENA-C	38-39	72-73			
FRATTINA-C	16	62	SARSINA-C	40	73-74			
FUEVA-C	30-37	68-72	STRIPE-C	41	74			
GIRON-C	23	65	TORAZZA-C	50	77			

REGISTER

ARTIKEL NUMBER
ARTIKELNUMMER
NUMÉROS D'ARTICLE

NUMBER NUMMER NUMÉRO	PAGE PRODUCT SEITE PRODUKT PAGE PRODUIT	PAGE TECHNIQUE SEITE TECHNIK PAGE TECHNIQUE	NUMBER NUMMER NUMÉRO	PAGE PRODUCT SEITE PRODUKT PAGE PRODUIT	PAGE TECHNIQUE SEITE TECHNIK PAGE TECHNIQUE	NUMBER NUMMER NUMÉRO	PAGE PRODUCT SEITE PRODUKT PAGE PRODUIT	PAGE TECHNIQUE SEITE TECHNIK PAGE TECHNIQUE
11585	57	79	96978	20	63	97906	14	60
11586	57	79	96979	20	64	97907	14	61
11659	57	80	96996	18	63	97908	14	61
11671	58	80	96997	18	63	97909	15	61
11672	58	80	97087	20	63	97911	15	61
11684	58	80	97219	50	77	97918	24	65
32589	23	65	97237	49	76	97921	25	66
32732	12	60	97239	50	77	97922	25	66
32733	41	74	97247	48	76	97936	12	60
32737	31	68	97248	48	76	97958	40	73
32738	30	68	97249	48	76	97959	40	73
32741	41	74	97295	49	77	97961	40	74
32753	32	69	97299	49	77	98105	53	78
32754	32	69	97446	54	79	98106	52	78
32881	31	69	97447	54	79	98107	52	78
32882	33	70	97475	44	74	98108	52	78
96662	38	72	97476	12	60			
96663	38	73	97482	46	75			
96664	39	73	97483	46	75			
96668	30	69	97484	46	75			
96669	34	70	97485	47	75			
96671	34	70	97629	38	72			
96672	35	71	97691	28	67			
96673	35	71	97692	28	67			
96676	32	70	97693	28	68			
96677	36	71	97694	29	68			
96678	36	71	97714	26	66			
96679	37	72	97715	26	66			
96681	37	72	97716	26	67			
96684	23	65	97717	27	67			
96686	22	64	97811	16	62			
96818	23	65	97812	16	62			
96819	22	64	97813	16	62			
96821	22	64	97814	16	62			

NOTES

NOTIZEN
NOTES





All previous catalogues and price lists are no longer valid with the issue of this catalogue. Errors, misprints, model and price changes and technical modifications are reserved. We deliver based on our terms of delivery and payment. Our products comply with the European light norm EN60598. Products with the ENEC test mark are conforming to the guide line 2006/95/EG. Products with additional safety remarks (e.g protection class, IP) are identified within the product family with the relevant symbol and number. The content of this catalogue is protected under copyright law for EGLO Leuchten GmbH. All rights reserved. Our specific written consent must be obtained before using any illustrations and texts. The pictures are 4C prints and may differ from the original.

The product pictures and ambiances in this catalogue can deviate from reality, and they do not necessarily concur with the usual application of the product. EGLO does not assume liability for the correctness, completeness or the application depiction of the products and/or the product information.

Design, layout and composition: EGLO GmbH, A-6136 Pill - AUSTRIA
Print: Kraft Premium GmbH, 76275 Ettlingen - GERMANY
Pictures: EGLO, Adobe Stock, istockphoto.com

Mit diesem Katalog verlieren alle vorhergehenden Kataloge und Preislisten ihre Gültigkeit. Irrtümer, Druckfehler, Modell- und Preisänderungen sowie technische Änderungen vorbehalten. Wir liefern zu unseren Liefer- und Zahlungsbedingungen. Unsere Produkte entsprechen der europäischen Leuchtnorm EN 60598. Produkte mit dem ENEC Prüfzeichen sind konform mit der Richtlinie 2006/95/EG. Produkte mit weiteren Sicherheitshinweisen (zB. Schutzklasse, IP) sind mit Symbol und Zahl bei der Produktfamilie ausgezeichnet. Der Inhalt dieses Kataloges ist für die EGLO Leuchten GmbH urheberrechtlich geschützt. Alle Rechte sind vorbehalten. Bilder und Texte dürfen nicht ohne vorherige ausdrückliche, schriftliche Genehmigung verwendet werden. Die Abbildungen sind 4C Drucke und können vom Original abweichen.

Die Katalogbilder und die gezeigten Darstellungen der Produkte können von der Wirklichkeit abweichen und nicht den üblichen Produktanwendungen entsprechen. EGLO übernimmt keine Haftung für die Richtigkeit, Vollständigkeit und Anwendungsdarstellung der Produkte und Produktinformationen.

Gestaltung, Layout und Satz: EGLO GmbH, A-6136 Pill - AUSTRIA
Druck: Kraft Premium GmbH, 76275 Ettlingen - GERMANY
Bilder: EGLO, Adobe Stock, istockphoto.com

Le présent catalogue remplace tous les catalogues et tarifs précédents. Sous réserve d'erreurs, de fautes d'impression, de modification des modèles et de changement de prix et de technique. Nous livrons sur la base de nos conditions de livraison et de paiement. Nos produits sont conformes aux normes européennes EN 60598 et portent le marquage CE. Les produits portant la marque ENEC sont conformes à la Directive 2006/95/EG. Les produits portant d'autres indications de sécurité (par exemple classe de protection, IP) sont identifiés par le symbole et le nombre correspondants dans la famille de produits.

Le contenu du présent catalogue est protégé pour la société EGLO Leuchten GmbH par un copyright. Tous droits réservés. Toute reproduction d'images et du texte est interdite sans autorisation explicite par écrit préalable. Les images sont imprimées en 4C et peuvent différer de l'original.

Les images des produits et les ambiances dans le catalogue peuvent dévier de la réalité et ne sont pas nécessairement en ligne avec l'usage habituel du produit. EGLO n'engage pas sa responsabilité sur la justesse des images et sur les informations relatives à l'usage pouvant être fait des produits.

Conception, maquette et composition: EGLO GmbH, A-6136 Pill - AUSTRIA
Presse: Kraft Premium GmbH, 76275 Ettlingen - GERMANY
Images: EGLO, Adobe Stock, istockphoto.com

09-2018



EGLO
my light | my style

EGLO Leuchten GmbH
Heiligkreuz 22
A-6136 Pill
Austria
Tel. +43 (0) 5242 6996
Fax +43 (0) 5242 6996-972
info@eglo.com
www.eglo.com

