



EGLO
my light | my style



2019

OUTDOOR LUMINAIRES

AUSSENLEUCHTEN
LUMINAIRES EXTÉRIEURS



Dear customers and business partners,
loyal EGLO friends,

Emphasize the features and put the architecture of your house or your green areas in the right light. However, outdoor luminaires are not only useful for aesthetic reasons but also provide the necessary security around your home, especially in the dark autumn and winter months.

With our Safety & Comfort luminaires, which are all equipped with motion sensors, you can keep uninvited visitors away. But we go one step further: our new luminaires with integrated camera in HD resolution, intercom system and a shooting angle of 180 degrees can be controlled via app from all over the world and are a further sign of EGLO's innovative product developments.

We wish you much pleasure with the new EGLO outdoor luminaires catalogue.

Geschätzte Kunden und Geschäfts-
partner, treue EGLO-Freunde,

Setzen Sie Akzente und rücken Sie die Architektur Ihres Hauses oder Ihrer Grünanlagen ins richtige Licht. Außenleuchten sind aber nicht nur aus ästhetischen Gründen sinnvoll, sondern sorgen vor allem in den dunklen Herbst- und traditionellen Wintermonaten für die nötige Sicherheit rund um Ihr zu Hause.

Mit unseren Leuchten der Linie Safety & Comfort, die alle über Bewegungssensoren verfügen, halten Sie ungebetene Besucher fern. Aber wir gehen noch einen Schritt weiter: unsere neuen Leuchten mit integrierter Kamera in HD-Auflösung, Gegensprechanlage und einem Aufnahmewinkel von 180 Grad lassen sich per App aus aller Welt steuern und sind ein weiteres Zeichen für die innovativen Produktentwicklungen von EGLO.

Wir wünschen Ihnen viel Freude mit dem neuen EGLO-Außenleuchtenkatalog.

Très chers clients et partenaires, fidèles
amis de EGLO,

Mettez des accents et mettez en valeur l'architecture de votre maison ou de vos espaces verts. Cependant, les luminaires extérieurs ne sont pas seulement utiles pour des raisons esthétiques, mais également pour assurer la sécurité nécessaire autour de votre maison, en particulier pendant les mois sombres d'automne et d'hiver.

Avec nos luminaires Safety & Comfort, tous équipés de capteurs de mouvement, vous pouvez éloigner les visiteurs indésirables. Mais nous allons encore plus loin : nos nouveaux luminaires avec caméra intégrée en résolution HD, nos installation d'interphonie et un angle de prise de vue de 180 degrés peuvent être commandés via des appli' du monde entier et sont un signe supplémentaire des développements de produits innovants d'EGLO.

Nous vous souhaitons beaucoup de plaisir avec le nouveau catalogue de luminaires extérieurs d'EGLO.



Mag. René Tiefenbacher
CEO EGLO Group



CONTENTS

INHALT
CONTENU



EGLO CONNECT

4-23



TOPLINE

104-119



SAFETY & COMFORT

24-35



CLASSIC

KLASSIK
CLASSIQUE

120-171



MODERN

MODERN
MODERNE

36-103



SPOTS, RECESSED & ACCESSOIRES

SPOTS, EINBAULEUCHTEN & ZUBEHÖR
SPOTS, LUMINAIRES ENCASTRÉS & ACCESSOIRES

172-201



GARDEN LIVING

202-205



INDEX & LEGEND

P. 206-224

INDEX & ERKLÄRUNG
INDEX & LÉGENDE

EI
EGLO WORLDWIDE
LEGEND
REGISTER
MEMO
IMPRESSUM

P.206-207
P.208-209
P.210-213
P.214-217
P.218-223
P.224

Light takes a
new direction:
Your direction



EGLO CONNECT

OVERVIEW

EGLO CONNECT



EGLO CONNECT
13



EGLO CONNECT
23



LM_LED_GU10
23



CONNECT REMOTE
14



LOCANA-C
14



PIOVE-C
14



LOCANA-C
14



CONNECT SENSOR
14



ARGOLIS-C
15



ARGOLIS-C
15



TORAZZA-C
16



MARCHESA-C
17



FRANCARI-C
17



LM_LED_E27
18



VERRES-C
18



CALDIERO-C
19



NISIA-C
20



VERLUCCA-C
21



MONTEROLO-C
22



NEMA 1-C
23



1

Luminaire / Bulb
Leuchte / Leuchtmittel
Luminaire / Ampoules

2

Remote Control / App
Fernbedienung / App
Télécommande / App

3 LET'S GO!!!

EASY, SMART & SAFE

EINFACH, INTELLIGENT & SICHER
SIMPLE, INTELLIGENT ET SÛR

If you're looking for easy installation and uncomplicated devices, EGLO connect is the right place for you.

Suchst du leichte Installationen und unkomplizierte Geräte - dann bist du bei EGLO connect genau richtig.

Des installations aisées et des appareils simples – EGLO connect est le bon dispositif pour toi.

Starting is made quick and easy, you only need 2 components:

Der Einstieg ist schnell und einfach, du benötigst nur 2 Komponenten:

Les premiers pas sont simples et rapides, tu as besoin de deux objets :

- › An EGLO connect luminaire / illuminant
- › An EGLO connect remote control or the free Awox Smart control App

- › Eine EGLO connect Leuchte / Leuchtmittel
- › Eine EGLO connect Fernbedienung oder die kostenlose Awox Smart control App

- › Une lampe / ampoule EGLO connect
- › Une télécommande EGLO connect ou l'application gratuite Awox Smart control

You'll be set to start immediately then!

Schon kann's losgehen!

Prêt à te lancer!

The system's basic advantages are:

Die grundlegenden Vorteile des Systems sind:

Les avantages primordiaux du système sont:



Simple installation

EGLO connect products use Bluetooth technology and do not need any elaborate installations.

Einfache Installation

EGLO connect Produkte verwenden Bluetooth Technologie und benötigen keine aufwändigen Installationen.

Une installation simple

Les produits EGLO connect emploient la technologie Bluetooth et ne nécessitent pas d'installations complexes.



Smart technology

The EGLO connect items communicate with each other to form a smart, expandible network (MESH-Technology).

Smarte Technologie

Die EGLO connect Artikel kommunizieren miteinander und bilden ein intelligentes, erweiterbares Netzwerk (MESH-Technology).

Une technologie intelligente

Les articles EGLO connect communiquent les uns avec les autres et forment un réseau intelligent et extensible (technologie MESH).



Protected network

All EGLO connect products in your home form a closed network and are secured against third-party access.

Geschütztes Netzwerk

Alle EGLO connect Produkte in deinem Zuhause bilden ein geschlossenes Netzwerk und sind vor fremdem Zugriff gesichert.

Un réseau protégé

Tous les produits EGLO connect dans ton foyer forment un réseau fermé et sont ainsi protégés des accès étrangers.

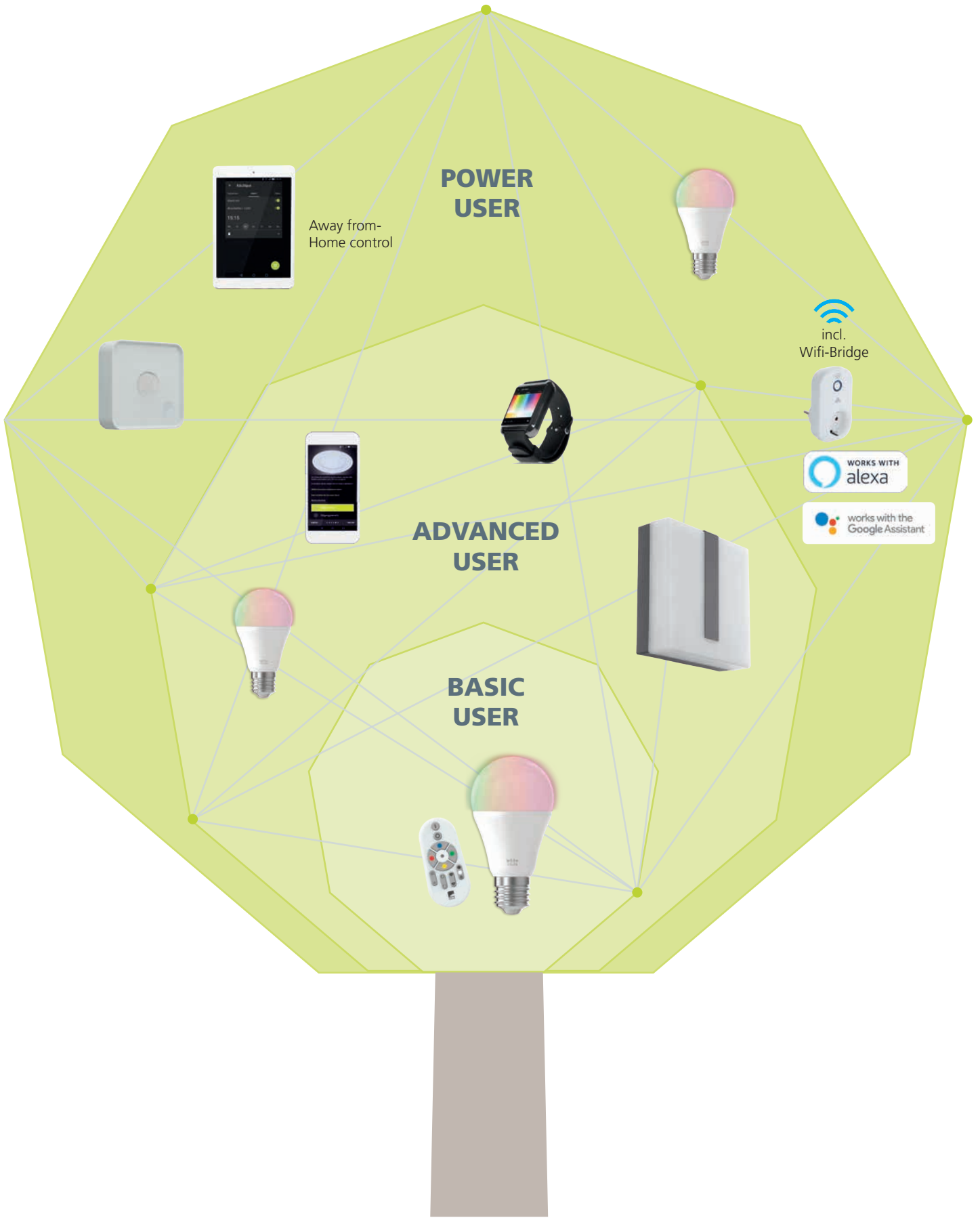

GROWS & LEARNS

WÄCHST & LERNT
APPRENDRE ET ÉVOLUER

EGLO connect grows to match your needs:

BASIC USER:

Use the EGLO connect remote control together with the EGLO connect lamps / luminaires to adjust brightness, colours and mood. These functions are practical, easy to handle and will meet your daily needs.

ADVANCED USER:

Use the App and expand your options: Combine living areas into groups to control lighting and other devices practically and quickly. Add to the experience of a movie night with the matching light scenario.

POWER USER:

Use the full potential of EGLO connect. Away from-Home control by integration in your WiFi, control by speech commands via Amazon Echo and Google Home, Day & Night function including motion detection and much more – the future of lighting in your home.

EGLO connect wächst mit deinen Bedürfnissen:

BASIC USER:

Du nutzt die EGLO connect Fernbedienung zusammen mit den EGLO connect Leuchtmitteln / Leuchten. Damit stellst du Helligkeit, Farbe und Stimmung ein. Diese Funktionen sind praktisch, einfach zu handhaben und genügen deinen täglichen Bedürfnissen.

ADVANCED USER:

Du nutzt die App und erweiterst deinen Spielraum: Fasse Wohnbereiche zu Gruppen zusammen, um Licht und andere Geräte praktisch und schnell ansteuern zu können. Verstärke das Erlebnis eines Filmabends mit dem passenden Lichtszenario.

POWER USER:

Du nutzt das volle Potential von EGLO connect. Away from-Home control durch Intergration in dein W-Lan, Steuerung per Sprachbefehl mit Hilfe von Amazon Echo und Google Home, Day & Night Funktion inklusive Bewegungserkennung und vieles mehr – Lichtzukunft in deinem Heim.

EGLO connect évolue avec tes besoins:

UTILISATEUR DE BASE:

Tu utilises la télécommande EGLO connect conjointement avec les ampoules/luminaires EGLO connect. Tu régles ainsi la luminosité, la couleur et l'ambiance. Ces fonctions sont pratiques, faciles à manier et suffisent à tes besoins au quotidien.

UTILISATEUR AVANCÉ:

Tu utilises l'application et accrois ta marge de manoeuvre : tu rassembles des zones d'habitat en des groupes afin de pouvoir commander la lumière et les autres appareils de manière rapide et pratique. Renforces l'ambiance d'une soirée film par la scénérie lumineuse correspondante.

UTILISATEUR PUISSANT:

Tu utilises l'ensemble du potentiel d'EGLO connect. Un contrôle hors de chez toi par l'intégration dans ton Wi-Fi, un pilotage par commande vocale avec Amazon Echo et Google Home, une fonction jour & nuit avec détection de mouvements et bien d'autres choses - l'avenir de l'éclairage dans ta maison.



INDOOR & OUTDOOR

INNEN & AUSSEN
INTÉRIEUR & EXTÉRIEUR

EGLO connect can be used with indoor as well as outdoor lighting fixtures.

Control your light anywhere and anytime, and enjoy the advantages of smart lighting. Use the EGLO connect sensor to increase safety around your home. Brightness and movement activate the light and will deter unwelcome guests. Never grope for a light switch again and keep your hands free to carry your purchases home.

Our EGLO connect outdoor lamps withstand any weather condition. These offer an attractive complimentary package, together with our indoor lamps.

EGLO connect ist für den Innen- und Außenbereich geeignet.

Steuere dein Licht jederzeit und überall und genieße die Vorteile smarter Beleuchtung. Mit dem EGLO connect Sensor erhöhst du die Sicherheit rund um dein Zuhause. Sowohl Helligkeit, als auch Bewegung aktivieren das Licht und schrecken ungebetene Gäste ab. Du musst nie wieder nach einem Lichtschalter tasten und hast die Hände frei, um Einkäufe nach Hause zu bringen.

Unsere EGLO connect Außenleuchten halten jeder Witterung stand und bilden zusammen mit unseren Innenleuchten ein attraktives Gesamtpaket.

EGLO connect convient pour une utilisation à l'intérieur et à l'extérieur.

Contrôle ta lumière à tout moment et de partout et prends plaisir aux avantages d'un éclairage intelligent. Avec le capteur EGLO connect, tu augmentes la sécurité autour de ta maison. Aussi bien la luminosité que des mouvements actionnent la lumière et découragent les visiteurs non souhaités. Tu n'as plus jamais à rechercher un interrupteur et tu as les mains libres pour rentrer les courses chez toi.

Nos luminaires extérieurs EGLO connect résistent à toute intempérie et forment communément avec tes luminaires intérieurs un ensemble attrayant.



ADVANTAGES OF THE CONNECT SENSOR

IP44 Safety no cabling necessary

The CONNECT SENSOR is battery-operated, so that no difficult cabling is necessary. The sensor can be mounted directly on the wall. With the mounting bracket (included in the delivery), you can easily adjust the detection range to your needs. This permits fine adjustment by 30 degrees to the left and right.

Night mode

When Night mode is enabled the luminaires receive the indication night or day from the CONNECT SENSOR. Choose from 3 sensitivity settings (25 to 75%).

Night movement detection

When Night movement detection is enabled the CONNECT SENSOR turns on the luminaires with the chosen light intensity when movement is detected. You can choose from 3 movement detection sensitivity settings. The light will turn off after the selected time when no movement is detected.

Combination of Night mode and Night movement detection

VORTEILE DES CONNECT SENSOR

IP44 Schutz Keine Verkabelung notwendig

Der CONNECT SENSOR ist batteriebetrieben, so dass keine schwierige Verkabelung erforderlich ist. Der Sensor kann direkt an die Wand montiert werden. Mit der Montagehalterung (im Lieferumfang enthalten) können Sie den Erfassungsbereich ganz einfach an Ihre Bedürfnisse anpassen. Dadurch ist eine Feinjustierung von 30 Grad nach links und rechts möglich.

Night mode

Wenn der Nachtmodus aktiviert ist, erhalten die Leuchten die Anzeige Nacht oder Tag vom CONNECT SENSOR. Wählen Sie aus 3 Empfindlichkeitseinstellungen (25 bis 75%).

Night movement detection

Wenn die Nachtbewegungserkennung aktiviert ist, schaltet der CONNECT SENSOR die Leuchten mit der gewählten Lichtintensität ein, wenn die Bewegung erkannt wird. Sie können aus 3 Bewegungserkennungssensibilitätseinstellungen wählen. Das Licht schaltet sich nach der gewählten Zeit aus, wenn keine Bewegung erkannt wird.

Kombination von Night mode und Night movement detection

ADVANTAGES DE LA CAPTEUR CONNECT

Protection IP44 Aucun câble nécessaire

Le CONNECT SENSOR est alimenté par batterie, donc aucun câblage difficile n'est nécessaire. Avec le support de montage (inclus dans la livraison), vous pouvez facilement ajuster l'étendue de la détection à vos besoins. Ce réglage fin de 30 degrés à gauche et à droite est possible.

Mode de nuit (Night mode)

Lorsque le mode de nuit est activé, les luminaires reçoivent l'indication du jour ou de la nuit du capteur CONNECT. Choisissez parmi 3 réglages de sensibilité (de 25 à 75%).

Détection de mouvement nocturne

Lorsque la détection de mouvement nocturne est activée, le CONNECT SENSOR allume les luminaires avec l'intensité lumineuse choisie lorsqu'un mouvement est détecté. Vous pouvez choisir parmi 3 réglages de sensibilité de détection de mouvement. Si aucun mouvement n'est détecté, la lumière s'éteindra après la période sélectionnée.

Combinaison du mode de nuit et de la détection de mouvement nocturne



Im Set
erhältlich
inkl.
Remote



11585 EGLO CONNECT

illuminant
Leuchtmittel
ampoule

L 116, Ø 60

E27	1x 9W	RGB-TW 2700-6500K	25000h	
220-240V, 50/60Hz	15000x	CRI >80		



A+



EGLO CONNECT ILLUMINANT

One illuminant – numerous possibilities: 16.7 million colours and over 50,000 white tones ensure the right atmosphere in your home at all times. The illuminant can be controlled via remote control or app using Bluetooth technology: You can control the brightness or adjust colour tones – and all this without complicated installation and comfortably from the sofa.

But the illuminant can do much more: it can be expanded at will using intelligent mesh technology, and up to 50 illuminants can be grouped together. This makes it easy to create and program a wide variety of lighting scenarios. You can also use the app to select from a large number of pre-set lighting scenes.

Security is not neglected either, as the illuminants form a self-contained network and are therefore protected from external access.

EGLO CONNECT LEUCHTMITTEL

Ein Leuchtmittel – zahlreiche Möglichkeiten: 16,7 Millionen Farben und über 50.000 Weißtöne sorgen jederzeit für die richtige Stimmung in Ihrem Heim. Über die Bluetooth-Technologie kann das Leuchtmittel per Fernbedienung oder App gesteuert werden: Sie können die Helligkeit kontrollieren oder Farbtöne einstellen – und das alles ohne aufwändige Installation und bequem vom Sofa aus.

Aber das Leuchtmittel kann noch viel mehr: es lässt sich per intelligenter Mesh-Technologie beliebig erweitern, bis zu 50 Leuchtmittel sind hierbei gruppierbar. So lassen sich problemlos und einfach unterschiedlichste Lichtszenarien erstellen und programmieren. Mit der App können Sie aber auch aus einer Vielzahl vorgegebener Lichtstimmungen auswählen.

Auch die Sicherheit kommt nicht zu kurz, denn die Leuchtmittel bilden ein in sich geschlossenes Netzwerk und sind somit vor Zugriffen von Außen geschützt.

AMPOULE EGLO CONNECT

Une seule ampoule – de nombreuses possibilités : 16,7 millions de couleurs et plus de 50 000 tons de blanc assurent à tout moment la bonne ambiance dans votre maison. L'ampoule peut être commandée via une télécommande ou une appli, utilisant la technologie Bluetooth : Vous pouvez contrôler la luminosité ou régler les tons de couleurs – et tout cela sans installation compliquée et de manière confortablement depuis votre canapé.

Mais l'ampoule peut faire beaucoup plus : elle peut être étendue à volonté grâce à la technologie Mesh intelligentes, et jusqu'à 50 ampoules peuvent être regroupées. Il est ainsi facile de créer et de programmer une grande variété de scène lumineuse. Vous pouvez également utiliser l'appli pour sélectionner un grand nombre d'ambiance lumineuse prédéfinies.

La sécurité n'est pas négligée non plus, car les ampoules forment un réseau fermé et sont donc protégées des accès externes.



32732 CONNECT REMOTE

remote control; plastic, white
Fernbedienung; Kunststoff, weiss
télécommande; plastique, blanc

L 110, B 53, H 20



ohne



9 002759 327323



B 53



97475 CONNECT SENSOR

accessory; plastic, white
Zubehör; Kunststoff, weiss
accessoire; plastique, blanc

L 60, H 60, A 40

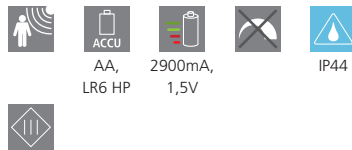

9 002759 974756

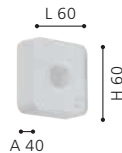

A 40

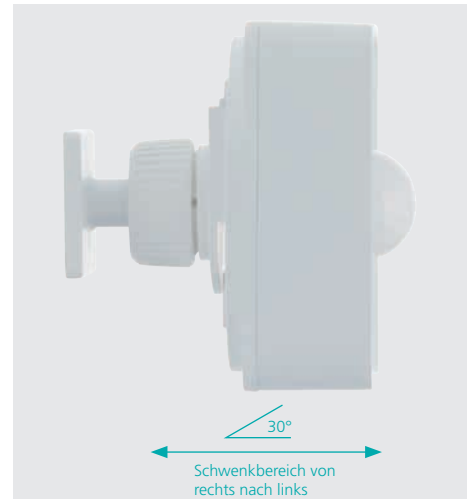

Schwenkbereich von rechts nach links

97475

With the mounting bracket (included in the delivery), you can easily adjust the detection range to your needs. This permits fine adjustment by 30 degrees to the left and right.

Mit der Montagehalterung (im Lieferumfang enthalten) können Sie den Erfassungsbereich ganz einfach an Ihre Bedürfnisse anpassen. Dadurch ist eine Feinjustierung von 30 Grad nach links und rechts möglich.

Avec le support de montage (inclus dans la livraison), vous pouvez facilement ajuster l'étendue de la détection à vos besoins. Ce réglage fin de 30 degrés à gauche et à droite est possible.



97295 PIOVE-C

wall / ceiling luminaire; cast aluminium, black / plastic, white
Wand- / Deckenleuchte; Aluguss, schwarz / Kunststoff, weiss
applique / plafonnier; fonte d'aluminium, noir / plastique, blanc

L 250, H 250, A 80



14W 1400lm



9 002759 972950

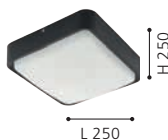

L 250



97237 LOCANA-C

wall / ceiling luminaire; zinc-plated steel, anthracite / plastic, white
Wand- / Deckenleuchte; Stahl verzinkt, anthrazit / Kunststoff, weiss
applique / plafonnier; acier galvanisé, anthracite / plastique, blanc

H 95, Ø 260



14W 1400lm



9 002759 972370

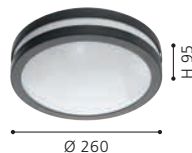

Ø 260



97299 LOCANA-C

wall / ceiling luminaire; zinc-plated steel, silver / plastic, white
Wand- / Deckenleuchte; Stahl verzinkt, silber / Kunststoff, weiss
applique / plafonnier; acier galvanisé, argent / plastique, blanc

H 95, Ø 260



14W 1400lm



9 002759 972998



Ø 260



98172 ARGOLIS-C

wall / ceiling luminaire; cast aluminium, white / plastic, white
Wand- / Deckenleuchte; Aluguss, weiss / Kunststoff, weiss
applique / plafonnier; fonte d'aluminium, blanc / plastique, blanc

L 300, B 300, H 35



22W 2600lm IP44

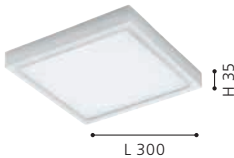

98171 ARGOLIS-C

wall / ceiling luminaire; cast aluminium, white / plastic, white
Wand- / Deckenleuchte; Aluguss, weiss / Kunststoff, weiss
applique / plafonnier; fonte d'aluminium, blanc / plastique, blanc

H 35, Ø 225

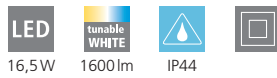

16,5W 1600lm IP44

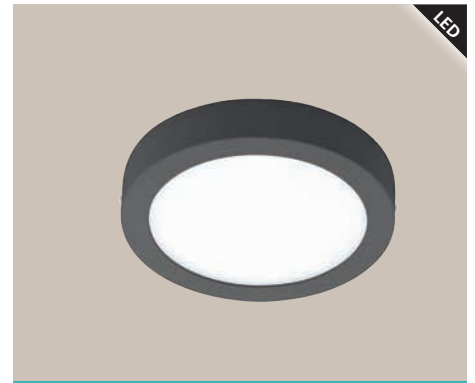
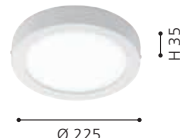

98173 ARGOLIS-C

wall / ceiling luminaire; cast aluminium, anthracite / plastic, white
Wand- / Deckenleuchte; Aluguss, anthrazit / Kunststoff, weiss
applique / plafonnier; fonte d'aluminium, anthracite / plastique, blanc

H 35, Ø 225

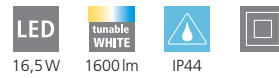

16,5W 1600lm IP44



98174 ARGOLIS-C

wall / ceiling luminaire; cast aluminium, anthracite / plastic, white
Wand- / Deckenleuchte; Aluguss, anthrazit / Kunststoff, weiss
applique / plafonnier; fonte d'aluminium, anthracite / plastique, blanc

L 300, B 300, H 35



22W 2600lm IP44

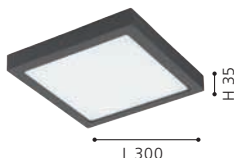



97219 TORAZZA-C

wall luminaire; plastic, steel, anthracite / plastic, satined
 Wandleuchte; Kunststoff, Stahl, anthrazit / Kunststoff, satiniert
 applique; plastique, acier, anthracite / plastique, satiné

L 215, H 215, A 70



1x 3x
 A-F 0-9

97219

Letters and numbers included in delivery.

Buchstaben und Zahlen im Lieferumfang enthalten.

Les lettres et les nombres sont inclus dans la livraison.

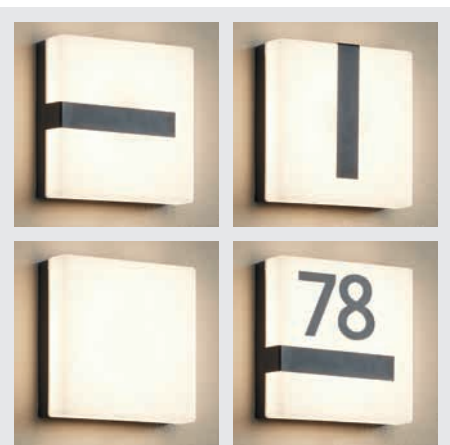

97219

This luminaire is delivered with freely positionable ornamental elements which are attached by means of adhesive tape.

Diese Leuchte wird mit frei positionierbaren Zierelementen geliefert, welche mittels Klebeband angebracht werden.

Ce luminaire est livrée avec éléments de décoration qui sont attachés au moyen du ruban adhésif.



98234 FRANCARI-C

wall luminaire; cast aluminium, black / plastic, white
Wandleuchte; Aluguss, schwarz / Kunststoff, weiss
applique; fonte d'aluminium, noir / plastique, blanc

L 220, H 255, A 250



15W 1600lm



IP44



9 002759 982348



98145 MARCHESA-C

wall / ceiling luminaire; stainless steel, stainless steel / plastic, white

Wand- / Deckenleuchte; Edelstahl, edelstahl / Kunststoff, weiss
applique / plafonnier; acier inoxydable, acier inoxydable / plastique, blanc

H 70, Ø 300



15W 1650lm



IP44



9 002759 981457



98145

Letters and numbers included in delivery.

Buchstaben und Zahlen im Lieferumfang enthalten.

Les lettres et les nombres sont inclus dans la livraison.

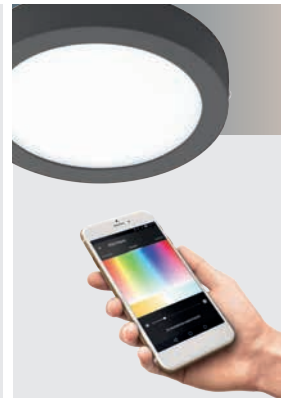

EGLO connect

Our EGLO connect outdoor lamps withstand any weather condition. They offer an attractive complimentary package, together with our indoor lamps.

Unsere EGLO connect Außenleuchten halten jeder Witterung stand und bilden zusammen mit unseren Innenleuchten ein attraktives Gesamtpaket.

Nos luminaires extérieurs EGLO connect résistent à toute intempérie et forment communément avec nos luminaires intérieurs un ensemble attrayant.



98145





806 lm

5 year warranty
5 Jahre Garantie
5 años de garantía

11684 LM_LED_E27

illuminant
Leuchtmittel
ampoule

L 118, Ø 60



9 002759 116842



A+



9W

60W



97239 VERRES-C

wall luminaire; stainless steel, plastic, stainless steel, white / plastic, white
Wandleuchte; Edelstahl, Kunststoff, edelstahl, weiss / Kunststoff, weiss
applique; acier inoxydable, plastique, acier inoxydable, blanc / plastique, blanc

L 180, H 290, A 90



9 002759 972394



A+

INCL.



EGLO CONNECT E27

The EGLO connect E27 lamp 11684 is included in the delivery of all luminaires on pages 18 to 21.

Das EGLO connect E27 Leuchtmittel 11684 ist bei allen Leuchten auf den Seiten 18 bis 21 im Lieferumfang inkludiert

L'ampoule EGLO E27 connect de référence 11684 est livrée avec tous les luminaires des pages 18 à 21.



97484

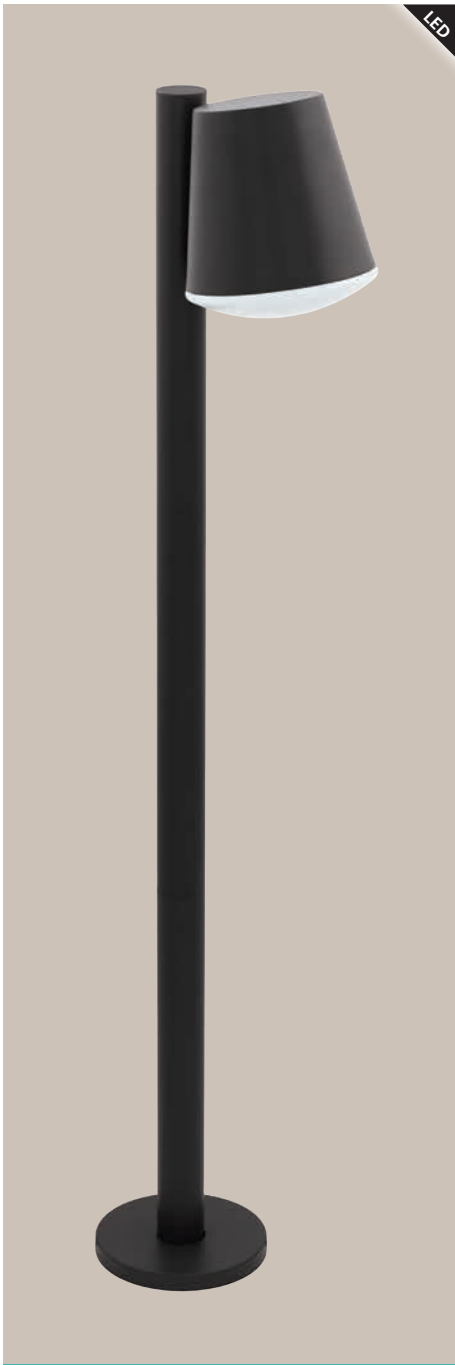

97483 CALDIERO-C

floor luminaire; zinc-plated steel, anthracite / plastic, white
 Stehleuchte; Stahl verzinkt, anthrazit / Kunststoff, weiss
 lampadaire; acier galvanisé, anthracite / plastique, blanc

L 240, B 140, H 965, Base: Ø 140

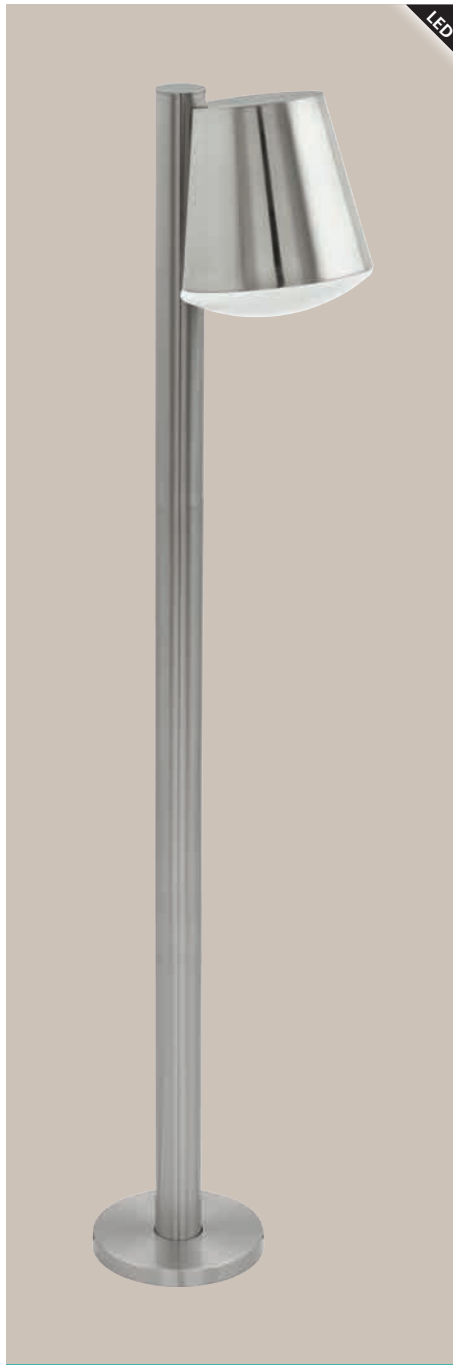
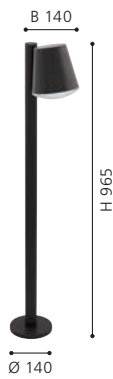
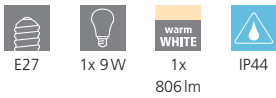

97485 CALDIERO-C

floor luminaire; stainless steel, stainless steel / plastic, white
 Stehleuchte; Edelstahl, edelstahl / Kunststoff, weiss
 lampadaire; acier inoxydable, acier inoxydable / plastique, blanc

L 240, B 140, H 965, Base: Ø 140

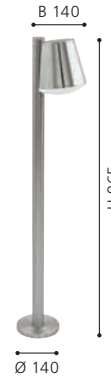
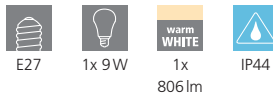

97482 CALDIERO-C

wall luminaire; zinc-plated steel, anthracite / plastic, white
 Wandleuchte; Stahl verzinkt, anthrazit / Kunststoff, weiss
 applique; acier galvanisé, anthracite / plastique, blanc

L 140, H 240, A 190

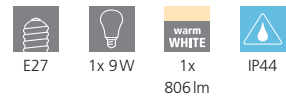

97484 CALDIERO-C

wall luminaire; stainless steel, stainless steel / plastic, white
 Wandleuchte; Edelstahl, edelstahl / Kunststoff, weiss
 applique; acier inoxydable, acier inoxydable / plastique, blanc

L 140, H 240, A 190

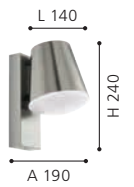
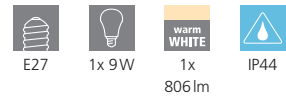

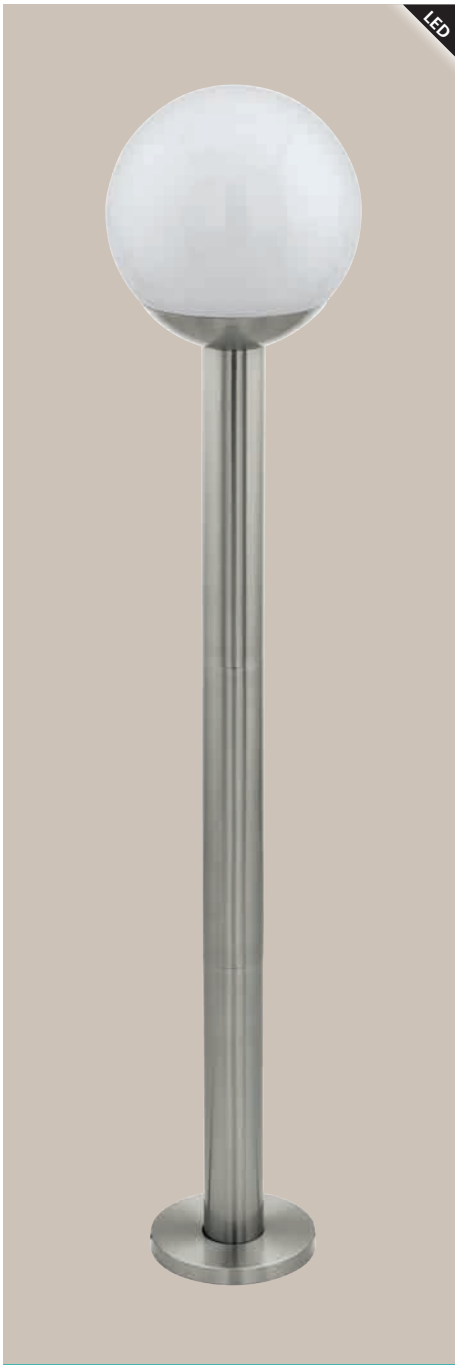

LED



LED



LED

97247 NISIA-C

wall luminaire; stainless steel, stainless steel / plastic, white
Wandleuchte; Edelstahl, edelstahl / Kunststoff, weiss
applique; acier inoxydable, acier inoxydable / plastique, blanc

L 200, H 315, A 220

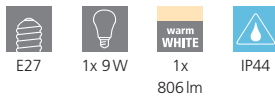

9 002759 972479



97248 NISIA-C

pedestal luminaire; stainless steel, stainless steel / plastic, white
Sockelleuchte; Edelstahl, edelstahl / Kunststoff, weiss
luminaire pour socle; acier inoxydable, acier inoxydable / plastique, blanc

H 525, Ø 200, Base: Ø 140

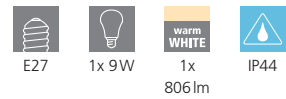

9 002759 972486



97249 NISIA-C

floor luminaire; stainless steel, stainless steel / plastic, white
Stehleuchte; Edelstahl, edelstahl / Kunststoff, weiss
lampadaire; acier inoxydable, acier inoxydable / plastique, blanc

H 980, Ø 200, Base: Ø 140

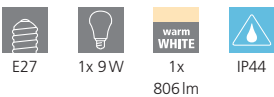

9 002759 972493

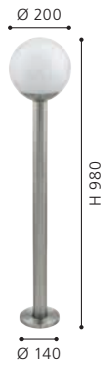

97247



97447 VERLUCCA-C

floor luminaire; zinc-plated steel, black / glass, clear, black
 Stehleuchte; Stahl verzinkt, schwarz / Glas, klar, schwarz
 lampadaire; acier galvanisé, noir / verre, clair, noir

H 990, Ø 210, Base: Ø 140

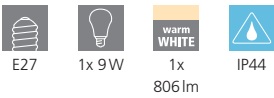

97446 VERLUCCA-C

wall luminaire; zinc-plated steel, black / glass, clear, black
 Wandleuchte; Stahl verzinkt, schwarz / Glas, klar, schwarz
 applique; acier galvanisé, noir / verre, clair, noir

L 210, H 265, A 245

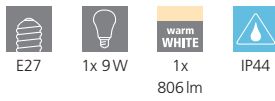

VERLUCCA C

With direct and/or indirect light this luminaire create a spectacular effect.

Diese Leuchten schaffen durch direktes und/oder indirektes Licht einen tollen Effekt.

Ce luminaire crée un effets lumineux special pour une illumination direct et/ou indirect.





98105 MONTEROLO-C

floor luminaire; plastic, white / plastic, white
 Stehleuchte; Kunststoff, weiss / Kunststoff, weiss
 lampadaire; plastique, blanc / plastique, blanc

H 300, Ø 300, Base: Ø 120

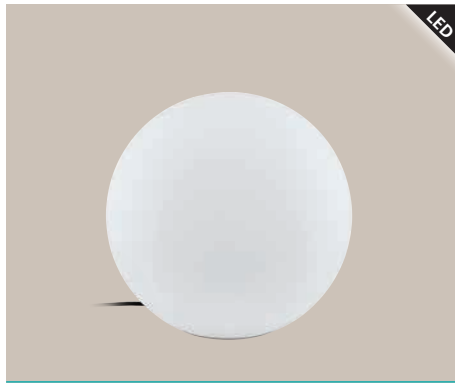
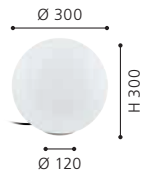
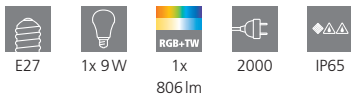

98106 MONTEROLO-C

floor luminaire; plastic, white / plastic, white
 Stehleuchte; Kunststoff, weiss / Kunststoff, weiss
 lampadaire; plastique, blanc / plastique, blanc

H 390, Ø 390, Base: Ø 195

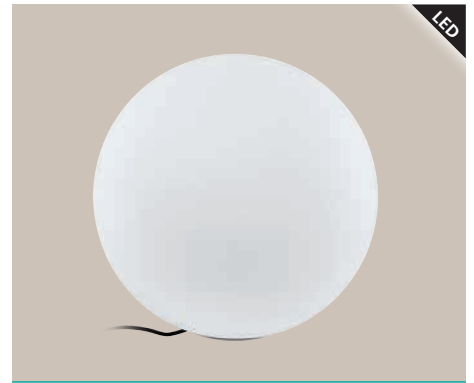
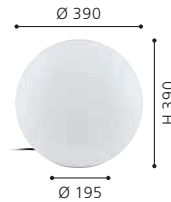
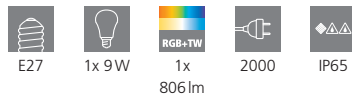

98107 MONTEROLO-C

floor luminaire; plastic, white / plastic, white
 Stehleuchte; Kunststoff, weiss / Kunststoff, weiss
 lampadaire; plastique, blanc / plastique, blanc

H 500, Ø 500, Base: Ø 195

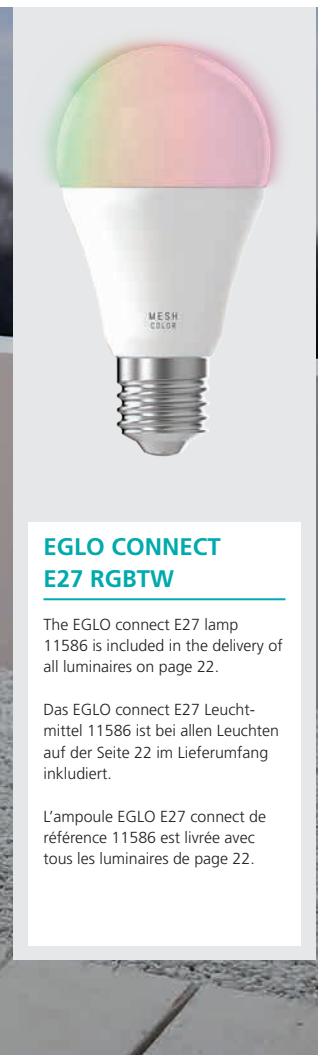
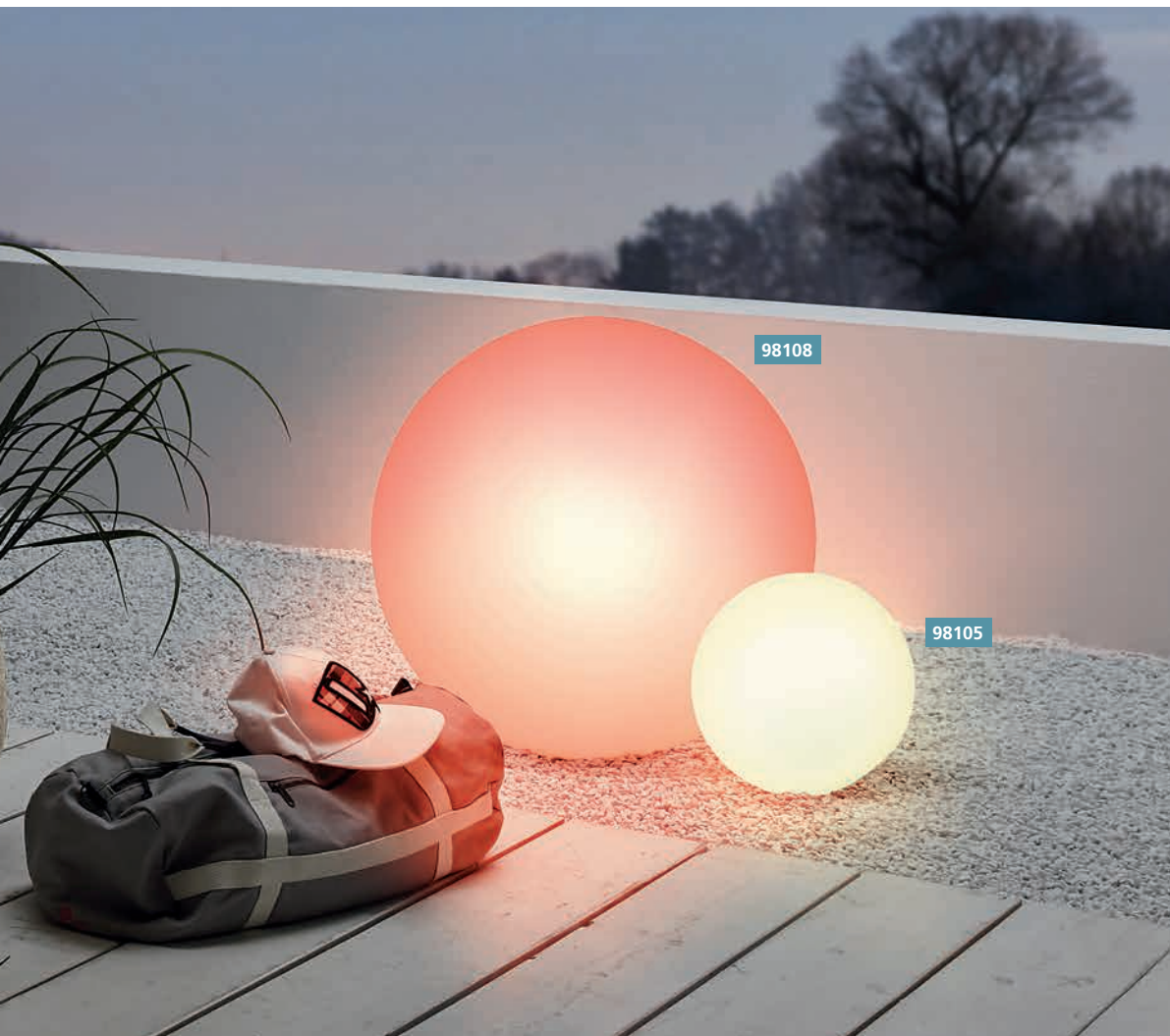
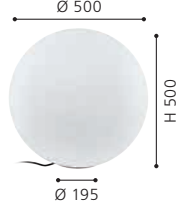
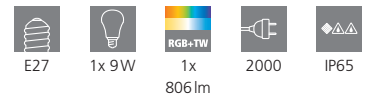

EGLO CONNECT E27 RGBTW

The EGLO connect E27 lamp 11586 is included in the delivery of all luminaires on page 22.

Das EGLO connect E27 Leuchtmittel 11586 ist bei allen Leuchten auf der Seite 22 im Lieferumfang inkludiert.

L'ampoule EGLO E27 connect de référence 11586 est livrée avec tous les luminaires de page 22.

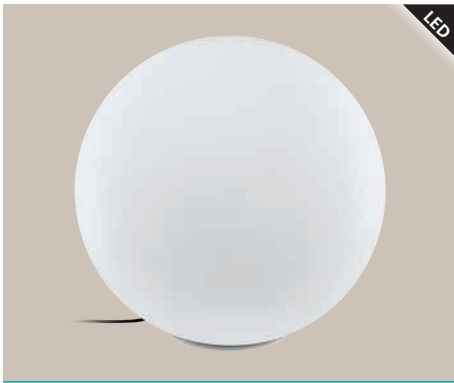

LED

98108 MONTEROLO-C

floor luminaire; plastic, white / plastic, white
 Stehleuchte; Kunststoff, weiss / Kunststoff, weiss
 lampadaire; plastique, blanc / plastique, blanc

H 600, Ø 600, Base: Ø 195

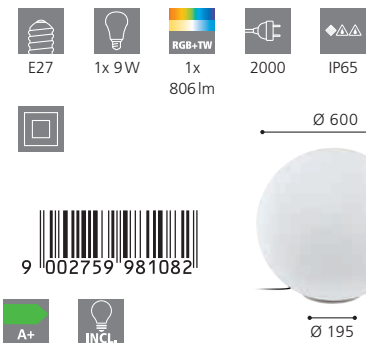

A+ INCL.



98052 NEMA 1-C

ground spike; plastic, black / plastic, transparent
 Erdspieß; Kunststoff, schwarz / Kunststoff, transparent
 piquet de terre; plastique, noir / plastique, transparent

L 130, B 60, H 245

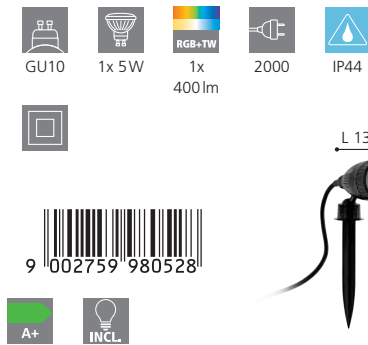

A+ INCL.



LED

400 lm

5 year warranty
 Jahre Garantie
 anni di garanzia
 años de garantía

11671 GU10-LED-RGBTW

illuminant
 Leuchtmittel
 ampoule

L 68, Ø 50

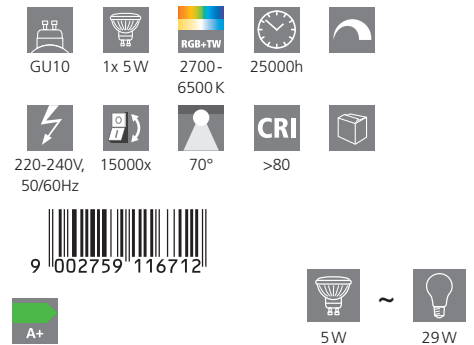

A+ 5W ~ 29W



LED

806 lm

5 year warranty
 Jahre Garantie
 anni di garanzia
 años de garantía

11586 E27-LED-RGBTW-A60

illuminant
 Leuchtmittel
 ampoule

L 116, Ø 60

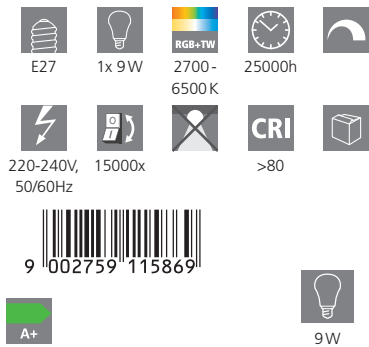

A+ 9W ~ 60W



98052

EGLO CONNECT GU10 RGBTW

The EGLO connect E27 lamp 11671 is included in the delivery of 98052 on page 23.

Das EGLO connect E27 Leuchtmittel 11671 ist bei 98052 auf der Seite 23 im Lieferumfang inkludiert.

L'ampoule EGLO E27 connect de référence 11671 est livrée avec tous 98052 de page 23.

SAFETY & COMFORT





**NOW
AVAILABLE
WITH CAMERA**



Jetzt erhältlich mit Kamera / Maintenant disponible avec caméra

SAFETY & COMFORT



Please observe the legal regulations of your country!

Bitte beachten Sie die gesetzlichen Bestimmungen Ihres Landes!

Veuillez respecter les réglementations légales de votre pays!



DAWN
SENSOR



120° MOTION
DETECTOR RANGE



180° CAMERA RANGE
1080P HD CAMERA



INTEGRATED MICROPHONE
AND SPEAKER



INTEGRATED
WIFI

Everything at a glance

Whether on the beach in Bali, on the mountains of Tyrol or in the restaurant next door: with the new EGLO HD luminaires you can keep an eye on your home everywhere in the world. The luminaires are equipped with an integrated 1080P HD camera with 180° camera angle and a motion sensor with 120° detection angle. This means that you will be informed about all processes around your home via push notification on your smartphone or tablet.

Alles im Blick

Egal ob am Strand in Bali, auf den Bergen Tirols oder im Restaurant nebenan: mit den neuen EGLO HD Leuchten haben Sie überall auf der Welt Ihr zu Hause im Blick. Die Leuchten sind mit einer integrierte 1080P HD Kamera mit 180° Kamerawinkel und einen Bewegungssensor mit 120° Erfassungswinkel ausgestattet. Somit werden Sie mittels Push-Benachrichtigung am Smartphone oder Tablet über alle Vorgänge rund um Ihr Heim informiert.

Tout en vue

Peu importe que l'on se trouve sur la plage à Bali, sur les montagnes du Tyrol ou dans un restaurant à côté de chez soi : grâce aux nouveaux luminaires HD d'EGLO, vous avez votre maison en vue partout dans le monde. Les luminaires sont équipés d'une caméra HD 1080P intégrée avec un angle de caméra de 180° et d'un capteur de mouvement avec un angle de détection de 120°. Cela signifie que vous serez informé de tous les processus autour de votre maison par le biais d'une notification apparaissant sur votre smartphone ou votre tablette.



Movement Detection

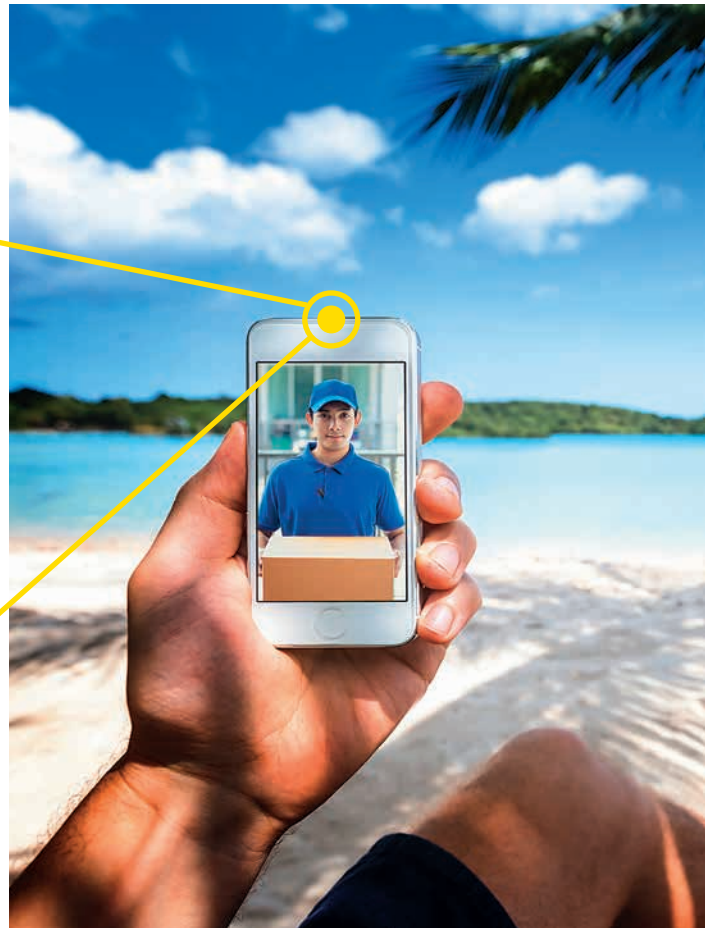

Communication via microphone and speaker



INTEGRATED MICROPHONE AND SPEAKER

Via Mobile Device you can communicate with the person in front of the camera.

INTEGRIERTES MIKROFON UND LAUTSPRECHER

Via Mobile Device kann mit der Person vor der Kamera kommuniziert werden.

MICROPHONES ET HAUT-PARLEURS INTÉGRÉS

Via Mobile Device, vous pouvez communiquer avec la personne devant la caméra.



PUSH NOTIFICATION

As soon as the camera turns on, you will receive a push notification on your tablet or mobile phone.

PUSH-BENACHRICHTIGUNG

Sobald sich die Kamera einschaltet, erhalten Sie auf Ihrem Tablet oder Handy eine Push-Benachrichtigung.

NOTIFICATION APPARAISSANT

Dès que la caméra s'allume, vous recevez une notification apparaissant sur votre tablette ou votre téléphone portable.



NIGHTLIGHT FUNCTION

The night light function can be activated via free app.

NACHTLICHT FUNKTION

Die Nachtlicht-Funktion kann per kostenloser App aktiviert werden.

NIGHTLIGHT FUNKTION

La fonction veilleuse peut être activée via appli gratuite.



MOTION DETECTION

When motion is detected, the camera turns on automatically. At dusk and at night, also the light is switched on.

BEWEGUNGSERKENNUNG

Bei Bewegungserkennung schaltet sich die Kamera automatisch ein. Bei Dämmerung und in der Nacht wird zusätzlich das Licht eingeschaltet.

DÉTECTION DE MOUVEMENTS

Lorsque la détection de mouvement est allumée, la caméra s'allume automatiquement. À la tombée de la nuit et lorsqu'il fait nuit, la lumière est également allumée.



INTERNAL MEMORY*

The memory card is built into the housing in such a way that external access is not possible.

INTERNER SPEICHER*

Die Speicherkarte ist so im Gehäuse verbaut, dass ein Zugriff von außen nicht möglich ist.

MÉMOIRE INTERNE*

La carte mémoire est intégrée dans le boîtier de telle sorte qu'un accès externe n'est pas possible.

* Recording of video and sound up to 96h (16 GB Micro SD card integrated), Video downloadable on Smartphone and Tablet / Aufnahme von Video und Ton bis zu 96h (16 GB Micro SD-Karte integriert), Video downloadbar auf Smartphone und Tablet / Enregistrement vidéo et audio jusqu'à 96 h (carte Micro SD 16 Go intégrée), Vidéo téléchargeable sur smartphone et tablette

SAFETY & COMFORT



Light at the right time

Smart light activated by movements offers many advantages. EGLO sensor luminaires and sensors provide you with a great deal of comfort in your daily life and increase the safety of your own four walls.

Licht zum richtigen Zeitpunkt

Smartes Licht, das durch Bewegungen aktiviert wird, bietet Ihnen viele Vorteile. Mit den Sensorleuchten und Sensoren von EGLO bringen Sie erheblichen Komfort in Ihren Alltag und erhöhen die Sicherheit rund um Ihr Zuhause.

Lumière au bon moment

Lumière intelligente, qui est activé par le mouvement, offre de nombreux avantages. Avec les lumières des capteurs et des capteurs de EGLO apporter un confort considérable dans votre vie quotidienne et d'augmenter la sécurité de vos propres quatre murs.



1. COMFORT



2. SAFETY



3. SECURITY



4. SAVE MONEY

1. COMFORT

The light comes on – without requiring you to push a button, leaving your hands free to carry your shopping bags. Come home comfortably with the sensors and sensor lamps by EGLO.

2. SAFETY

EGLO sensors and sensor lamps will show you thresholds and tripping hazards in time. Lower your accident risk in and around your home.

3. SECURITY

Motion detection will safely light up badly visible areas when this is necessary. You will always be able to see what is happening and can deter unbidden guests with the EGLO sensors and sensor lamps.

4. SAVE MONEY

Sensors and sensor lamps by EGLO help you save money. Your light will only come on when it is needed, and lower the energy costs for every home.

1. KOMFORT

Das Licht geht an – ohne dass Sie einen Schalter drücken mussten und Sie haben die Hände frei, um die Einkäufe zu tragen. Kommen Sie komfortabel nach Hause mit den Sensoren und Sensorleuchten von EGLO.

2. SICHERHEIT

EGLO Sensoren und Sensorleuchten lassen Sie Schwellen und Stolperfallen rechtzeitig erkennen. Senken Sie dadurch das Unfallrisiko in und um Ihr Zuhause.

3. SCHUTZ

Durch die Erfassung von Bewegung können schlecht sichtbare Bereiche beleuchtet werden, wenn es notwendig ist. Sehen Sie immer was passiert und schrecken Sie ungebetene Gäste mit EGLO Sensoren und Sensorleuchten ab.

4. GELD SPAREN

Sensoren und Sensorleuchten von EGLO helfen Ihnen bares Geld zu sparen. Das Licht geht nur an wenn es benötigt wird und senkt damit die Energiekosten in Ihrem Zuhause.

1. COMFORT

La lumière s'allume – sans que vous n'avez besoin de presser un interrupteur et vous avez les mains libres pour porter les achats. Entrez confortablement chez vous avec les capteurs et les luminaires à capteurs d'EGLO.

2. SÛRETÉ

Les capteurs et les luminaires à capteurs d'EGO vous permettent de déceler d'avance les seuils et sources de trébuchement. Réduisez ainsi les risques d'accident dans et autour de votre foyer.

3. SÉCURITÉ

Il est possible grâce à la saisie des mouvements d'éclairer au besoin des zones difficiles à voir. Ayez toujours un œil sur ce qu'il se passe et découragez les intrus avec les capteurs et les lampes à capteur d'EGO.

4. DE L'ARGENT EN SÉCURITÉ

Les capteurs et les lampes à capteur d'EGLO vous aident à économiser de l'argent comptant. La lumière ne vient que lorsque celle-ci est requise, ce qui réduit ainsi les dépenses énergétiques de tout foyer.

OVERVIEW

SAFETY & COMFORT

Chapter / Kapitel / Chapitre Modern / Kamera HD



MANFRIA-HD
p.40



MARCHESA-HD
p.56

Chapter / Kapitel / Chapitre Modern / Sensor



MANFRIA
p.40



CORNALE
p.42



AMAROSI
p.44



FIUMICINO
p.46



ATOLLARI
p.52



ATOLLARI
p.52



POLIENTO
p.58



NISIA
p.62



HELSINKI
p.64



HELSINKI
p.64



HELSINKI
p.65



CALDIERO
p.66



FAVRIA 1
p.76



FAVRIA 1
p.76



FAVRIA
p.76



FAVRIA
p.76



TRONO STICK
p.78



TRIBANO
p.78



SESIMBA 1
p.82



SESIMBA 1
p.82



SESIMBA 1
p.82



BREGANZO 1
p.94



BREGANZO 1
p.94



CERNO
p.96



FRANCARI
p.54



PERNATE
p.55



CICERONE
p.56



CALDIERO
p.67



RIGA 5
p.72



RIGA 5
p.72



AZZINANO
p.79



MUSSOTTO
p.79



VERRES
p.79



CITY
p.96



CITY
p.96



RALORA 1
p.98



OVERVIEW

SAFETY & COMFORT

Chapter / Kapitel / Chapitre **Topline / Sensor**



SAKEDA
p.108



PROPENDA
p.110



PROPENDA
p.110



BELCREDA
p.112



BELCREDA
p.112



CHEIRA
p.118

Chapter / Kapitel / Chapitre **Classic / Kamera HD**



MONTEVECCHIO-HD
p.146

Chapter / Kapitel / Chapitre **Classic / Sensor**



SIRMIONE
p.128



VERLUCCA
p.131



LISIO
p.157



MOUNA
p.157



SIDNEY
p.158



SOSSANO
p.160



SOSSANO
p.161



MONSELICE
p.161



MANERBIO
p.161



LATERNA 4
p.163



LATERNA 5
p.165



NAVEDO
p.166



MONSELICE
p.160



MANERBIO
p.160



NAVEDO
p.170



OVERVIEW

SAFETY & COMFORT

Chapter / Kapitel / Chapitre

Spots / Recessed & Accessoires / Sensor



PAGINO
p.176



PAGINO
p.176



PAGINO
p.176



PAGINO
p.176



CASABAS
p.176



CASABAS
p.176



PALIZZI
p.178



PASTION
p.178



CASABAS
p.178



CASABAS
p.178



LM_LED_E27
p.181



DETECT ME 5
p.181



DETECT ME 5
p.181



DETECT ME 6
p.182



DETECT ME 6
p.182



DETECT ME 3
p.182



DETECT ME 3
p.182



DETECT ME 4
p.182



DETECT ME 4
p.182



DETECT ME 1
p.183



DETECT ME 1
p.183



FAEDO 3
p.186



FAEDO 3
p.186



FAEDO 3
p.186



FAEDO 3
p.186



FAEDO 3
p.191



FAEDO 3
p.191



FAEDO 3
p.191



FAEDO 3
p.191



MODERN

MODERN
MODERNE

CLEAR LINES - A straight-lined and minimalist design ensures a modern touch. The luminaires made of stainless steel, aluminium or steel, combined with refined glass elements, will make your outdoor area shine in a modern and yet timeless light.

KLARE LINIEN - Geradliniges und minimalistisches Design sorgt für einen modernen Touch. Die Leuchten aus Edelstahl, Aluminium oder Stahl, kombiniert mit edlen Glaselementen, lassen Ihren Außenbereich modern und dennoch zeitlos erstrahlen.



LIGNES DISTINCTIVES - Un design minimaliste et à lignes droites assure un flair moderne. Associés à de nobles éléments en verre, les luminaires en acier, acier inoxydable ou en aluminium laissent votre extérieur rayonner d'un aspect moderne et pourtant intemporel.



OVERVIEW

MODERN



MANFRIA
40



PONSO
42



CORNALE
42



MONTEROS
43



AMAROSI
44



CULPINA
45



FIUMICINO
46



DONINNI 1
48

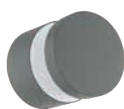

MELZO
51



MELZO
51



ATOLLARI
52



MAZZINI
53



FRANCARI
54



BIOSGA
55



PERNATE
55



CICERONE
56



MARCHESA-HD
56



POLIENTO
58



BASALGO 1
60



NISIA
62



ONCALA
63



HELSINKI
64



CALDIERO
66



STOCKHOLM 1
69



ROBLEDO
69



BEVERLY
70



MERLITO
70



RIGA-LED
71



RIGA 5
72



RIGA
72



RIGA
73



TONEGO
74



CISTIerna
75



FAVRIA
76



DARIL
78



TRONO STICK
78



OROPPOS
79



AZZINANO
79



MUSSOTTO
79



VERRES
79



VENTO 1
80



ONTANEDA
80



VENTO 2
80



ARGOLIS
80



PILONE
81



SESIMBA 1
82



MORINO
84



PREDAZZO
84



GORZANO
84



REDONDO
85



BOSARO
86



AGOLADA
87



JORBA
88



PERAFITA
89

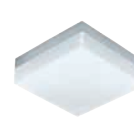

SONELLA
90



ARGOLIS
90

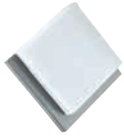

INFESTO 1
91



SITIA
92



KIBEA
93



NADELA
93



BINASCO
93



PARK
94



BREGANZO
94



CERNO
96



CERNO
96



CITY
96



CITY
96



CITY
96



CITY
96



RALORA
98



TABO
98



ACATE
98



RALORA 1
98



TABO-LED
99



PIAS
99



CALGARY 1
99



SEVILLA
100



MILTON
100



LEPUS
100



ENTRIMO
100



ONJA
102



ANOLA
103



LORMES
103



PENALVA
68



98097 MANFRIA

floor luminaire; aluminium, anthracite, white
 Stehleuchte; Alu, anthrazit, weiss
 lampadaire; aluminium, anthracite, blanc

L 135, B 75, H 870



98098 MANFRIA

wall luminaire; aluminium, anthracite, white
 Wandleuchte; Alu, anthrazit, weiss
 applique; aluminium, anthracite, blanc

L 200, H 325, A 80



98094 MANFRIA-HD

wall luminaire; cast aluminium, anthracite, white
 Wandleuchte; Aluguss, anthrazit, weiss
 applique; fonte d'aluminium, anthracite, blanc

L 200, H 300, A 80

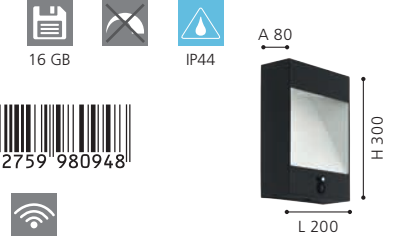

98095 MANFRIA

wall luminaire; aluminium, anthracite, white
 Wandleuchte; Alu, anthrazit, weiss
 applique; aluminium, anthracite, blanc

L 200, H 300, A 80



98096 MANFRIA

pedestal luminaire; aluminium, anthracite, white
 Sockelleuchte; Alu, anthrazit, weiss
 luminaire pour socle; aluminium, anthracite, blanc

L 135, B 75, H 380



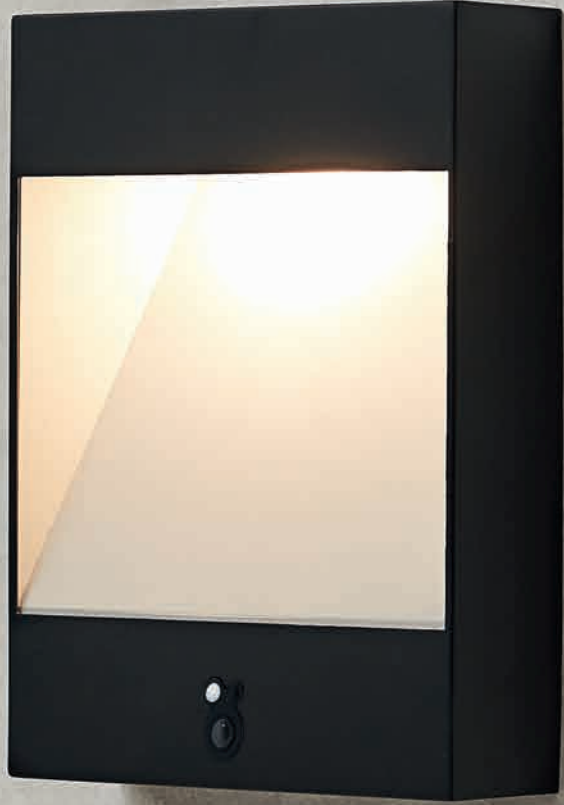

98094



97117 PONSO

wall luminaire; zinc-plated steel, anthracite, white / glass, clear
Wandleuchte; Stahl verzinkt, anthrazit, weiss / Glas, klar
applique; acier galvanisé, anthracite, blanc / verre, clair

L 180, H 230, A 85



1x 4,8W 450lm



9 002759 971175



97289 CORNALE

wall / ceiling luminaire; plastic, anthracite / plastic, white
Wand- / Deckenleuchte; Kunststoff, anthrazit / Kunststoff, weiss
applique / plafonnier; plastique, anthracite / plastique, blanc

L 215, H 215, A 70



1x 8,2W 1x 820lm



9 002759 972899

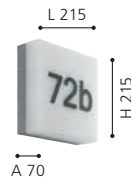

97289

Automatic illumination. This photoelectric lighting controller is used for controlling lighting systems for building fronts and automatically switches light 'ON' at dusk automatically 'OFF' again at dawn. Of course, the light-level threshold at which the sensor responds and turns the light 'ON' is defined by no other than you yourself.

Automatische Beleuchtung. Der Day & Night Sensor dient zur Steuerung von Beleuchtungsanlagen an Hausfronten und schaltet bei Dämmerung automatisch Licht AN und am Morgen automatisch wieder AUS. Die Dämmerungsschwelle, bei der der Sensor reagiert und die Beleuchtung schaltet, definieren Sie natürlich selbst.

Un éclairage automatique. Le Interrupteur crépusculaire pour la commande des installations d'éclairage pour les façades de maison e il allume automatiquement la lumière au crépuscule et l'éteint automatiquement à l'aube. C'est naturellement à vous de définir le seuil de luminosité auquel doit réagir le détecteur et allumer la lumière.



97117



1x A-F 3x 0-9

97289, 97117

Letters and numbers included in delivery.

Buchstaben und Zahlen im Lieferumfang enthalten.

Les lettres et les nombres sont inclus dans la livraison.



98144 MONTEROS

wall luminaire; aluminium, anthracite / satin glass, white
 Wandleuchte; Alu, anthrazit / Glas satiniert, weiss
 applique; aluminium, anthracite / verre satiné, blanc

L 250, H 335, A 95



E27 1x 40W IP44



9 002759 981440



A+++



98144



98143 MONTEROS

wall luminaire; aluminium, white / satin glass, white
 Wandleuchte; Alu, weiss / Glas satiniert, weiss
 applique; aluminium, blanc / verre satiné, blanc

L 250, H 335, A 95



E27 1x 40W IP44



9 002759 981433



A+++





98091 AMAROSI

wall luminaire; aluminium, black / plastic, white
Wandleuchte; Alu, schwarz / Kunststoff, weiss
applique; aluminium, noir / plastique, blanc

L 170, H 210, A 205



11 W 1200 lm



98092 AMAROSI

wall luminaire; aluminium, black / plastic, white
Wandleuchte; Alu, schwarz / Kunststoff, weiss
applique; aluminium, noir / plastique, blanc

L 170, H 210, A 205



11 W 1200 lm



98091, 98092, 98144, 98143, 98147

Letters and numbers included in delivery.

Buchstaben und Zahlen im Lieferumfang enthalten.

Les lettres et les nombres sont inclus dans la livraison.



98091



98087 CULPINA

wall luminaire; aluminium, white / plastic, white
Wandleuchte; Alu, weiss / Kunststoff, weiss
applique; aluminium, blanc / plastique, blanc

L 190, H 270, A 80



1x 10W 1100lm



98088 CULPINA

wall luminaire; aluminium, anthracite / plastic, white
Wandleuchte; Alu, anthrazit / Kunststoff, weiss
applique; aluminium, anthracite / plastique, blanc

L 190, H 270, A 80



1x 10W 1100lm



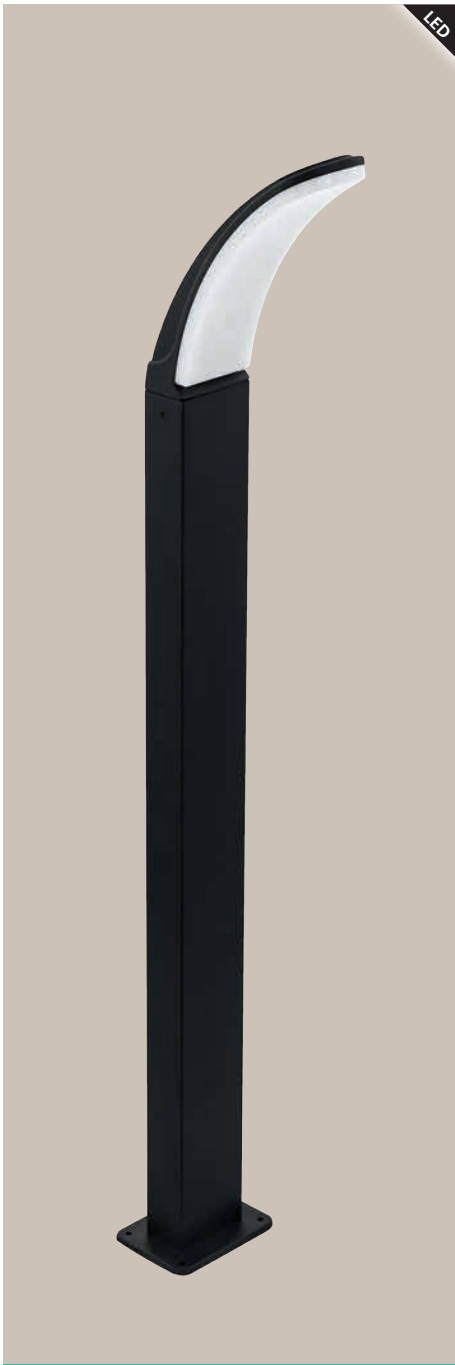

LED



LED



LED

98151 FIUMICINO

pedestal luminaire; aluminium, black / plastic, white
 Sockelleuchte; Alu, schwarz / Kunststoff, weiss
 luminaire pour socle; aluminium, noir / plastique, blanc

H 450, Base: B 110, T 80



1x 11 W

1500lm

IP44



9 002759 981518



98148 FIUMICINO

wall luminaire; aluminium, black / plastic, white
 Wandleuchte; Alu, schwarz / Kunststoff, weiss
 applique; aluminium, noir / plastique, blanc

L 70, H 180, A 190



1x 11 W

1500lm

IP44



9 002759 981488



LED



100°, 8 m
 5 sec. - 5 min.

SAFETY & COMFORT

98152 FIUMICINO

floor luminaire; aluminium, black / plastic, white
 Stehleuchte; Alu, schwarz / Kunststoff, weiss
 lampadaire; aluminium, noir / plastique, blanc

H 900, Base: B 110, T 80



1x 11 W

1500lm

IP44



9 002759 981525



98149 FIUMICINO

wall luminaire; aluminium, black / plastic, white
 Wandleuchte; Alu, schwarz / Kunststoff, weiss
 applique; aluminium, noir / plastique, blanc

L 70, H 180, A 190



1x 11 W

1500lm

IP44



9 002759 981495





98148

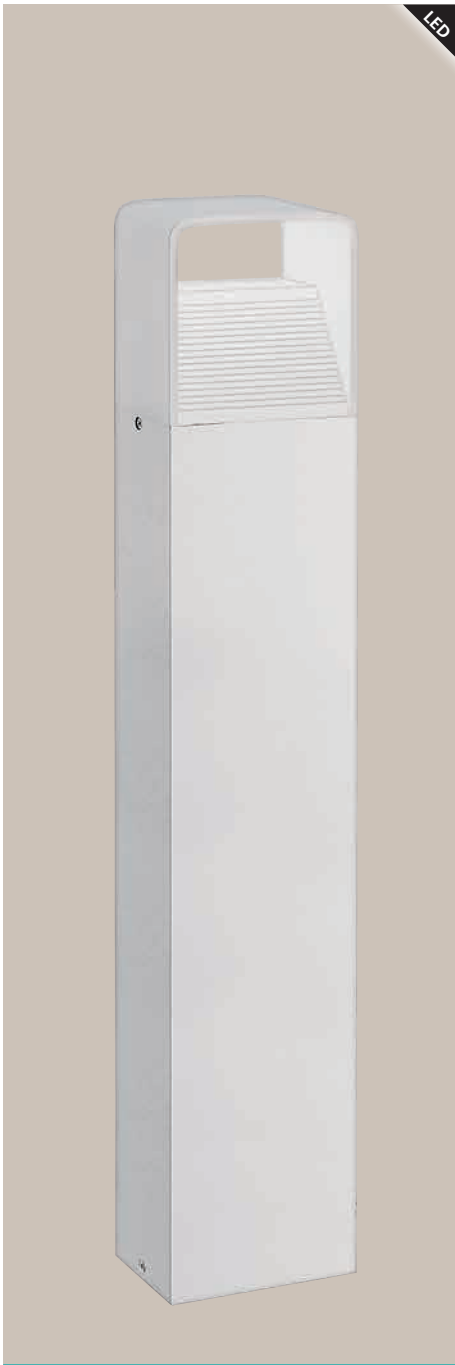

98267 DONINNI 1

pedestal luminaire; aluminium, white / plastic, white
 Sockelleuchte; Alu, weiss / Kunststoff, weiss
 luminaire pour socle; aluminium, blanc / plastique, blanc

L 135, B 75, H 400



98266 DONINNI 1

wall luminaire; aluminium, white / plastic, white
 Wandleuchte; Alu, weiss / Kunststoff, weiss
 applique; aluminium, blanc / plastique, blanc

L 135, B 120, H 75



98268 DONINNI 1

floor luminaire; aluminium, white / plastic, white
 Stehleuchte; Alu, weiss / Kunststoff, weiss
 lampadaire; aluminium, blanc / plastique, blanc

L 135, B 75, H 800

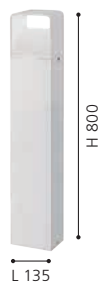

98271 DONINNI 1

pedestal luminaire; aluminium, anthracite / plastic, white
 Sockelleuchte; Alu, anthrazit / Kunststoff, weiss
 luminaire pour socle; aluminium, anthracite / plastique, blanc

L 135, B 75, H 400



98269 DONINNI 1

wall luminaire; aluminium, anthracite / plastic, white
 Wandleuchte; Alu, anthrazit / Kunststoff, weiss
 applique; aluminium, anthracite / plastique, blanc

L 135, B 120, H 75





98272 DONINNI 1

floor luminaire; aluminium, anthracite / plastic, white
 Stehleuchte; Alu, anthrazit / Kunststoff, weiss
 lampadaire; aluminium, anthracite / plastique, blanc

L 135, B 75, H 800

LED

6W

warm
WHITE

750lm



IP44



9 002759 982720

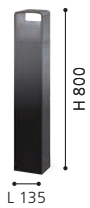

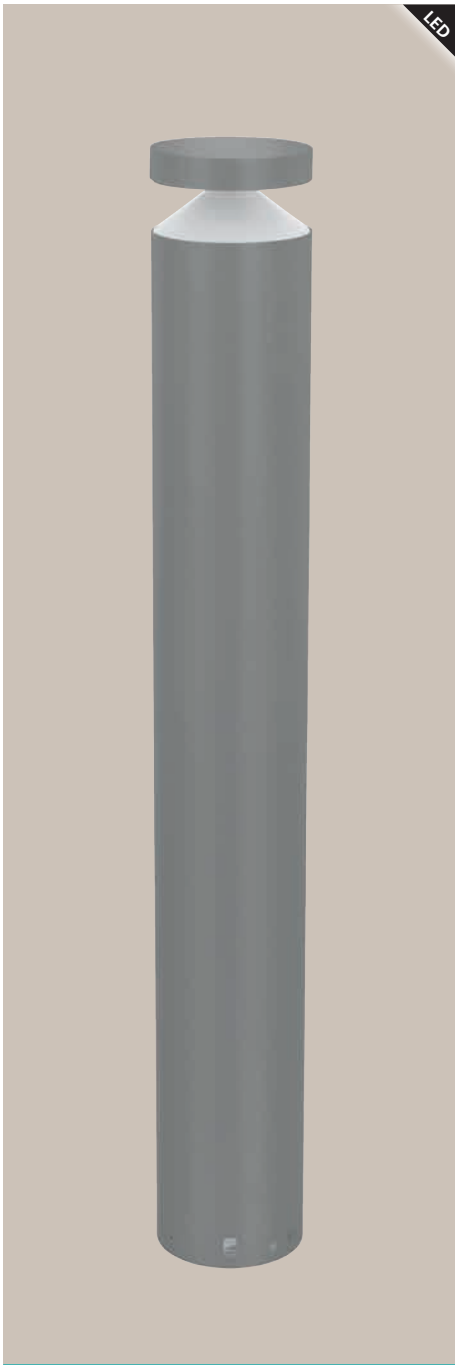

LED

97302 MELZO

floor luminaire; cast aluminium, silver / plastic, transparent
 Stehleuchte; Aluguss, silber / Kunststoff, transparent
 lampadaire; fonte d'aluminium, argent / plastique, transparent

H 990, Ø 135



1x 11 W 1x 950lm

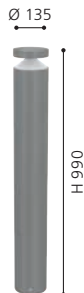

9 002759 973025



LED

97304 MELZO

floor luminaire; cast aluminium, black / plastic, transparent
 Stehleuchte; Aluguss, schwarz / Kunststoff, transparent
 lampadaire; fonte d'aluminium, noir / plastique, transparent

H 990, Ø 135



1x 11 W 1x 950lm



9 002759 973049



LED

97632 MELZO

pedestal luminaire; cast aluminium, black / plastic, transparent
 Sockelleuchte; Aluguss, schwarz / Kunststoff, transparent
 luminaire pour socle; fonte d'aluminium, noir / plastique, transparent

H 450, Ø 135



1x 11 W 1x 950lm



9 002759 976323



LED

97631 MELZO

pedestal luminaire; cast aluminium, silver / plastic, transparent
 Sockelleuchte; Aluguss, silber / Kunststoff, transparent
 luminaire pour socle; fonte d'aluminium, argent / plastique, transparent

H 450, Ø 135



1x 11 W 1x 950lm



9 002759 976316

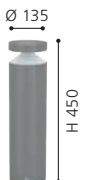

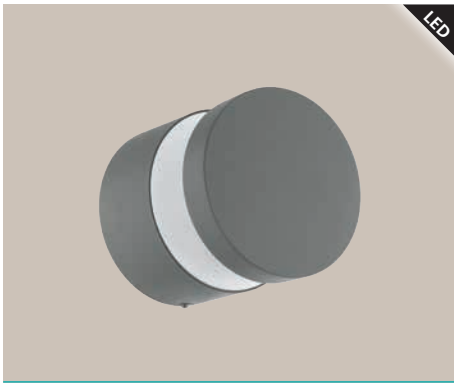

97301 MELZO

wall luminaire; cast aluminium, silver / plastic, transparent
Wandleuchte; Aluguss, silber / Kunststoff, transparent
applique; fonte d'aluminium, argent / plastique, transparent

97303 MELZO

wall luminaire; cast aluminium, black / plastic, transparent
Wandleuchte; Aluguss, schwarz / Kunststoff, transparent
applique; fonte d'aluminium, noir / plastique, transparent

H 130, Ø 135



1x 11 W
1x
950lm

H 130, Ø 135



1x 11 W
1x
950lm

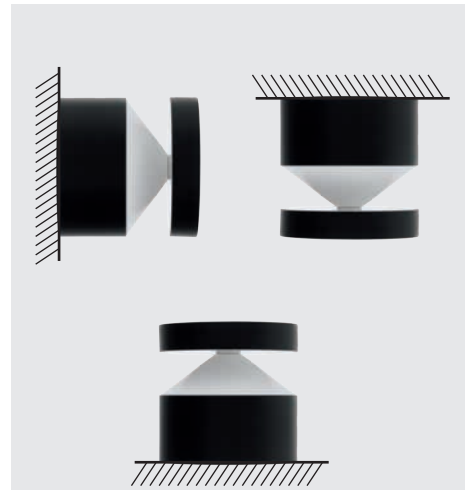

97301, 97303

These lamps have diverse uses: They can be installed on the wall or on the ceiling. The lamps variable design also permits floor placement.

Diese Leuchten sind vielseitig einsetzbar: sie können sowohl an der Wand, als auch an der Decke montiert werden. Ebenfalls ist durch das variable Design der Leuchte eine Bodenplatzierung möglich.

Ces luminaires sont d'une application multiple : ils peuvent être aussi bien montés sur le mur qu'attachés au plafond. Un placement au sol est aussi rendu possible par le design variable des luminaires.



9 002759 973018

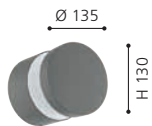

9 002759 973032





96276 ATOLLARI

wall luminaire; cast aluminium, anthracite / plastic, white
 Wandleuchte; Aluguss, anthrazit / Kunststoff, weiss
 applique; fonte d'aluminium, anthracite / plastique, blanc

L 100, H 230, A 155

2x 6W	2x 500lm			



9 002759 962760

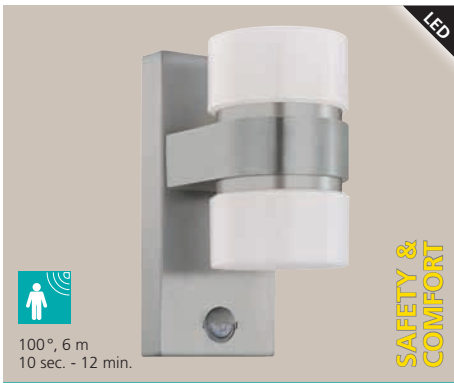

96277 ATOLLARI

wall luminaire; cast aluminium, stainless steel, silver / plastic, white
 Wandleuchte; Aluguss, edelstahl, silber / Kunststoff, weiss
 applique; fonte d'aluminium, acier inoxydable, argent / plastique, blanc

L 100, H 230, A 155

2x 6W	2x 500lm			



9 002759 962777

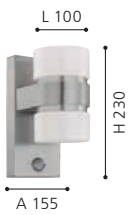

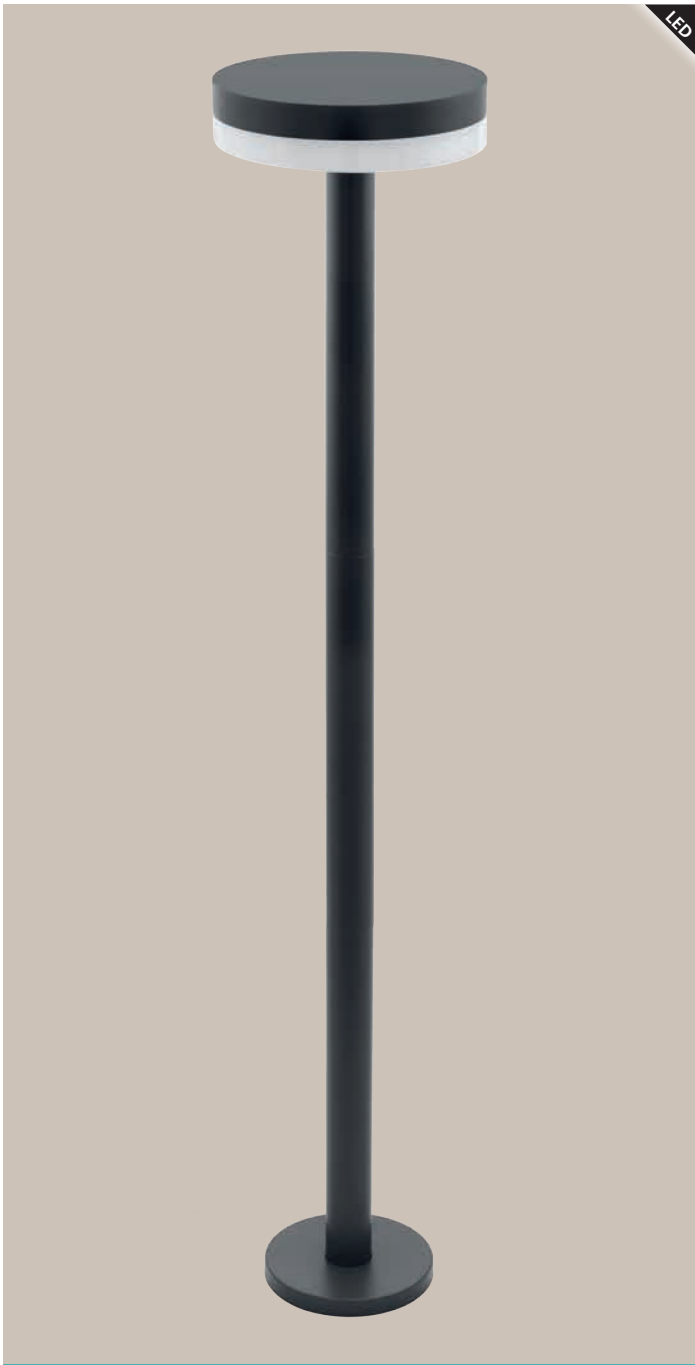

97145 MAZZINI

floor luminaire; cast aluminium, anthracite / plastic, white
 Stehleuchte; Aluguss, anthrazit / Kunststoff, weiss
 lampadaire; fonte d'aluminium, anthracite / plastique, blanc

L 200, H 1000, Base: Ø 140

LED	warm WHITE		
1x 11 W	1x		IP44
	950lm		



9 002759 971458



97144 MAZZINI

wall luminaire; cast aluminium, anthracite / plastic, white
 Wandleuchte; Aluguss, anthrazit / Kunststoff, weiss
 applique; fonte d'aluminium, anthracite / plastique, blanc

L 200, H 180, A 245

LED	warm WHITE		
1x 11 W	1x		IP44
	950lm		



9 002759 971441





98233



98233 FRANCARI

wall luminaire; cast aluminium, anthracite / plastic, white
Wandleuchte; Aluguss, anthrazit / Kunststoff, weiss
applique; fonte d'aluminium, anthracite / plastique, blanc

L 220, H 295, A 230



98232 FRANCARI

wall luminaire; cast aluminium, anthracite / plastic, white
Wandleuchte; Aluguss, anthrazit / Kunststoff, weiss
applique; fonte d'aluminium, anthracite / plastique, blanc

L 220, H 255, A 225





LED

97307 PERNATE

wall luminaire; cast aluminium, anthracite / plastic, white

Wandleuchte; Aluguss, anthrazit / Kunststoff, weiss

applique; fonte d'aluminium, anthracite / plastique, blanc

L 250, H 235, A 170

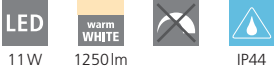

11 W 1250lm IP44



9 002759 973070

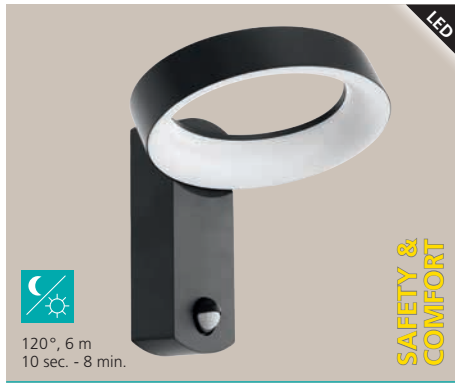

LED

97308 PERNATE

wall luminaire; cast aluminium, anthracite / plastic, white

Wandleuchte; Aluguss, anthrazit / Kunststoff, weiss

applique; fonte d'aluminium, anthracite / plastique, blanc

L 250, H 235, A 170



11 W 1250lm IP44



9 002759 973087



SAFETY & COMFORT

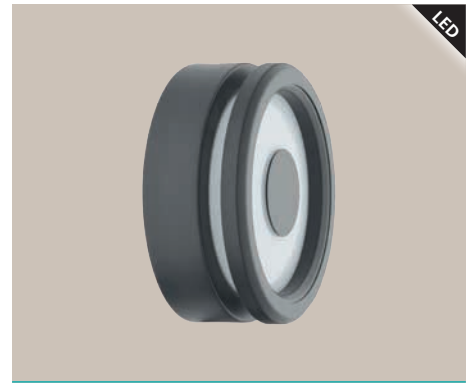

LED

97148 BIOSGA

wall luminaire; zinc-plated steel, anthracite / plastic, white

Wandleuchte; Stahl verzinkt, anthrazit / Kunststoff, weiss

applique; acier galvanisé, anthracite / plastique, blanc

Ø 180, A 65



1x 11 W 950lm IP44



9 002759 971489

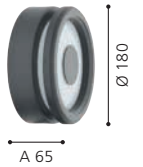

97308



98146 MARCHESA-HD

wall luminaire; stainless steel, stainless steel / plastic, white
 Wandleuchte; Edelstahl, edelstahl / Kunststoff, weiss
 applique; acier inoxydable, acier inoxydable / plastique, blanc

H 70, Ø 300, A 80



98147 MARCHESA

wall luminaire; stainless steel, stainless steel / plastic, white
 Wandleuchte; Edelstahl, edelstahl / Kunststoff, weiss
 applique; acier inoxydable, acier inoxydable / plastique, blanc

H 70, Ø 300, A 80



98128 CICERONE

wall luminaire; stainless steel, plastic, stainless steel, silver / plastic, white
 Wandleuchte; Edelstahl, Kunststoff, edelstahl, silber / Kunststoff, weiss
 applique; acier inoxydable, plastique, acier inoxydable, argent / plastique, blanc

L 200, H 315, A 175



98127 CICERONE

wall luminaire; stainless steel, plastic, stainless steel, silver / plastic, white
 Wandleuchte; Edelstahl, Kunststoff, edelstahl, silber / Kunststoff, weiss
 applique; acier inoxydable, plastique, acier inoxydable, argent / plastique, blanc

L 200, H 315, A 175





98127



90°, 7 m
10 sec. - 4 min.

**SAFETY &
COMFORT**

95017 POLIENTO

wall luminaire; stainless steel, stainless steel / plastic, glass, clear, white

Wandleuchte; Edelstahl, edelstahl / Kunststoff, Glas, klar, weiss

applique; acier inoxydable, acier inoxydable / plastique, verre, clair, blanc

L 150, H 325, A 195



E27



1x 40W



IP44



9 002759 950170



95016 POLIENTO

wall luminaire; stainless steel, stainless steel / plastic, glass, clear, white

Wandleuchte; Edelstahl, edelstahl / Kunststoff, Glas, klar, weiss

applique; acier inoxydable, acier inoxydable / plastique, verre, clair, blanc

L 150, H 325, A 195



E27



1x 40W



IP44



9 002759 950163



95018 POLIENTO

pedestal luminaire; stainless steel, stainless steel / plastic, glass, clear, white

Sockelleuchte; Edelstahl, edelstahl / Kunststoff, Glas, klar, weiss
luminaire pour socle; acier inoxydable, acier inoxydable / plastique, verre, clair, blanc

H 500, Ø 150, Base: Ø 115



E27



1x 40W



IP44



9 002759 950187



95016





95018



94277 BASALGO 1

wall luminaire; stainless steel, stainless steel / plastic, clear, white
 Wandleuchte; Edelstahl, edelstahl / Kunststoff, klar, weiss
 applique; acier inoxydable, acier inoxydable / plastique, clair, blanc

L 105, H 180, A 210

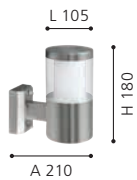

94278 BASALGO 1

floor luminaire; stainless steel, stainless steel / plastic, clear, white
 Stehleuchte; Edelstahl, edelstahl / Kunststoff, klar, weiss
 lampadaire; acier inoxydable, acier inoxydable / plastique, clair, blanc

H 450, Ø 105

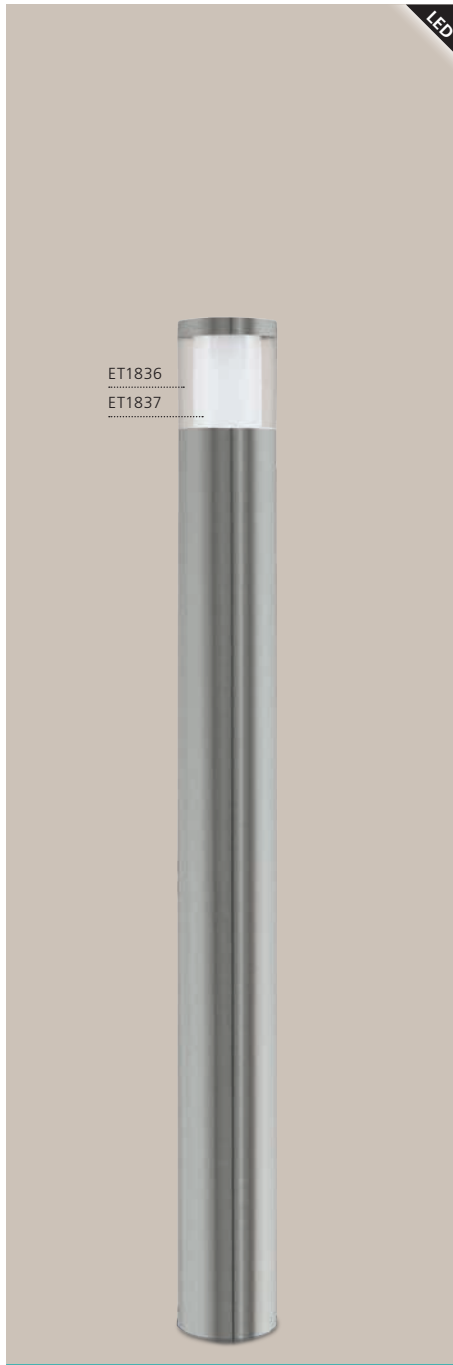
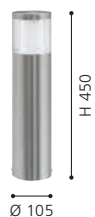

94279 BASALGO 1

floor luminaire; stainless steel, stainless steel / plastic, clear, white
 Stehleuchte; Edelstahl, edelstahl / Kunststoff, klar, weiss
 lampadaire; acier inoxydable, acier inoxydable / plastique, clair, blanc

H 1050, Ø 105

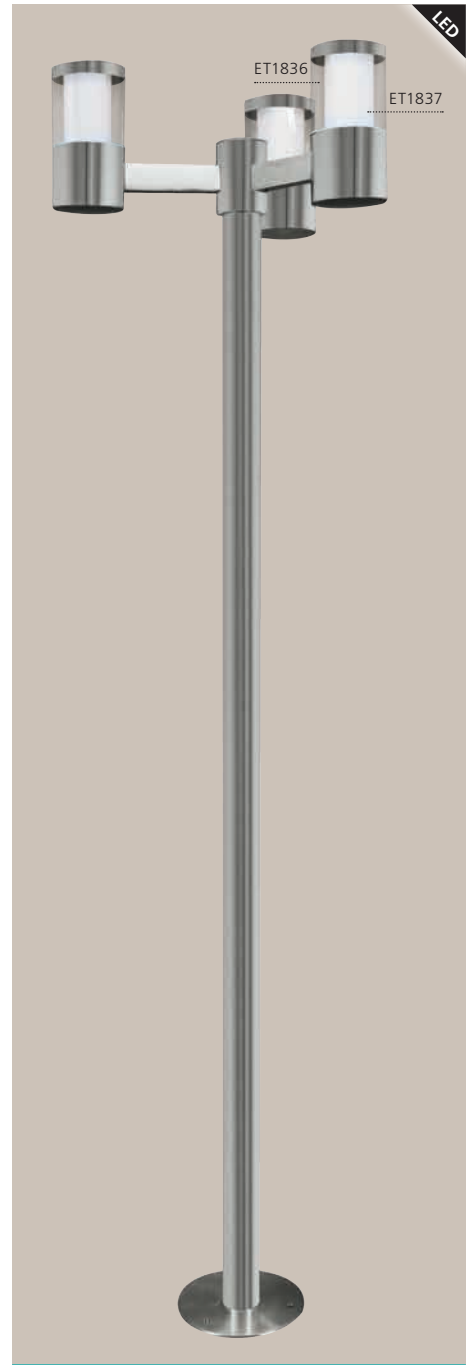

94281 BASALGO 1

floor luminaire; stainless steel, stainless steel / plastic, clear, white
 Stehleuchte; Edelstahl, edelstahl / Kunststoff, klar, weiss
 lampadaire; acier inoxydable, acier inoxydable / plastique, clair, blanc

H 1900, Ø 490, Base: Ø 205

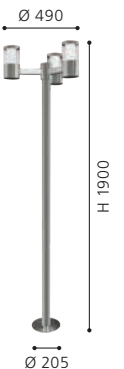
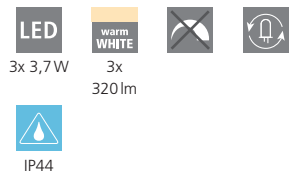



94278



94277



GL2852



GL2852



90°, 8 m
5 sec. - 4 min.

SAFETY &
COMFORT

27126 NISIA

wall luminaire; stainless steel, stainless steel / glass, white

Wandleuchte; Edelstahl, edelstahl / Glas, weiss

applique; acier inoxydable, acier inoxydable / verre, blanc

L 200, H 355, A 240



E27



1x 60W



IP44



9 002759 271268



GL2852

30206 NISIA

floor luminaire; stainless steel, stainless steel / satin glass, white

Stehleuchte; Edelstahl, edelstahl / Glas satiniert, weiss

lampadaire; acier inoxydable, acier inoxydable / verre satiné, blanc

H 500, Ø 200, Base: Ø 130



E27



1x 60W



IP44



9 002759 302061



30207 NISIA

floor luminaire; stainless steel, stainless steel / satin glass, white

Stehleuchte; Edelstahl, edelstahl / Glas satiniert, weiss

lampadaire; acier inoxydable, acier inoxydable / verre satiné, blanc

H 1000, Ø 200



E27



1x 60W



IP44

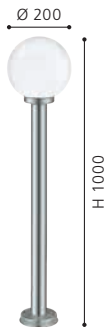

9 002759 302078



30205 NISIA

wall luminaire; stainless steel, stainless steel / satin glass, white

Wandleuchte; Edelstahl, edelstahl / Glas satiniert, weiss

applique; acier inoxydable, acier inoxydable / verre satiné, blanc

L 200, H 360, A 240



E27



1x 60W



IP44



9 002759 302054



95982 ONCALA

wall luminaire; stainless steel, stainless steel / satin glass, white

Wandleuchte; Edelstahl, edelstahl / Glas satiniert, weiss

applique; acier inoxydable, acier inoxydable / verre satiné, blanc

L 150, H 140, A 190



11W



950lm



IP44



9 002759 959821





95982

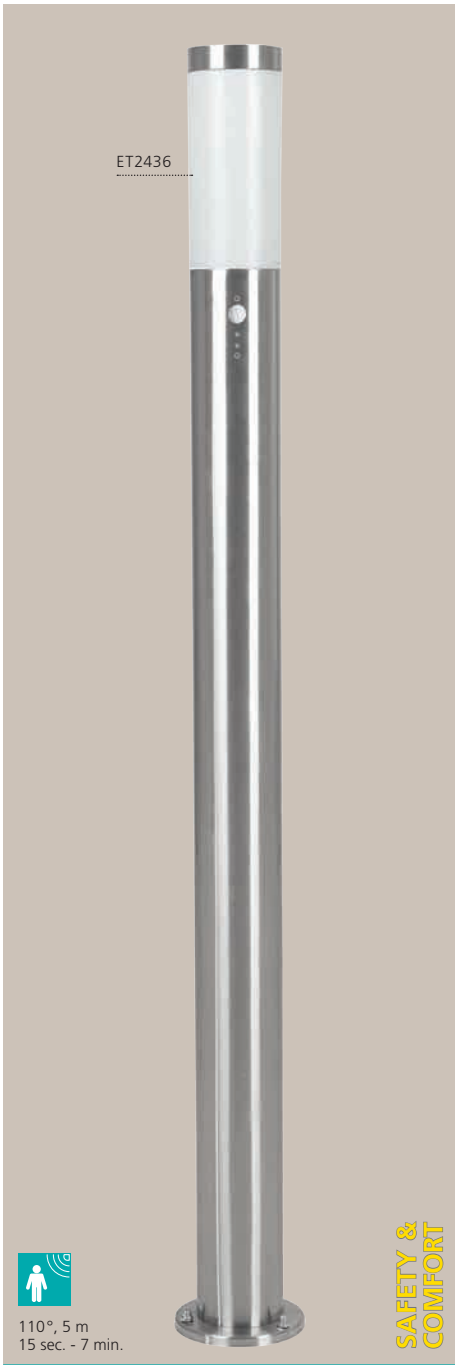

83281 HELSINKI

floor luminaire; stainless steel, stainless steel / plastic, white
 Stehleuchte; Edelstahl, edelstahl / Kunststoff, weiss
 lampadaire; acier inoxydable, acier inoxydable / plastique, blanc

H 1100, Ø 75, Base: Ø 115

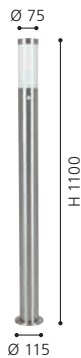

81752 HELSINKI

floor luminaire; stainless steel, stainless steel / plastic, white
 Stehleuchte; Edelstahl, edelstahl / Kunststoff, weiss
 lampadaire; acier inoxydable, acier inoxydable / plastique, blanc

H 1100, Ø 75, Base: Ø 115

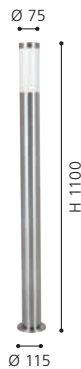

83279 HELSINKI

floor luminaire; stainless steel, stainless steel / plastic, white
 Stehleuchte; Edelstahl, edelstahl / Kunststoff, weiss
 lampadaire; acier inoxydable, acier inoxydable / plastique, blanc

H 450, Ø 75, Base: Ø 115



81751 HELSINKI

floor luminaire; stainless steel, stainless steel / plastic, white
 Stehleuchte; Edelstahl, edelstahl / Kunststoff, weiss
 lampadaire; acier inoxydable, acier inoxydable / plastique, blanc

H 450, Ø 75, Base: Ø 115

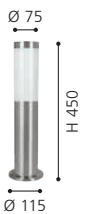

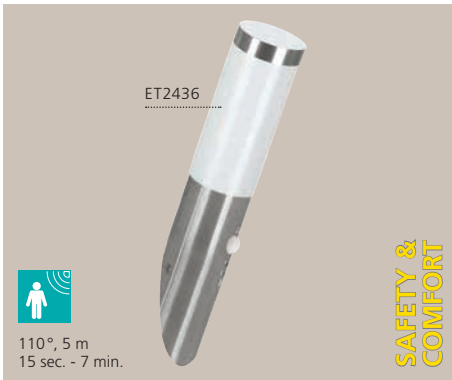

83278 HELSINKI

wall luminaire; stainless steel, stainless steel / plastic, white
Wandleuchte; Edelstahl, edelstahl / Kunststoff, weiss
applique; acier inoxydable, acier inoxydable / plastique, blanc

H 425, Ø 75, A 165



81753 HELSINKI

wall luminaire; stainless steel, stainless steel / plastic, white
Wandleuchte; Edelstahl, edelstahl / Kunststoff, weiss
applique; acier inoxydable, acier inoxydable / plastique, blanc

H 390, Ø 75, A 165



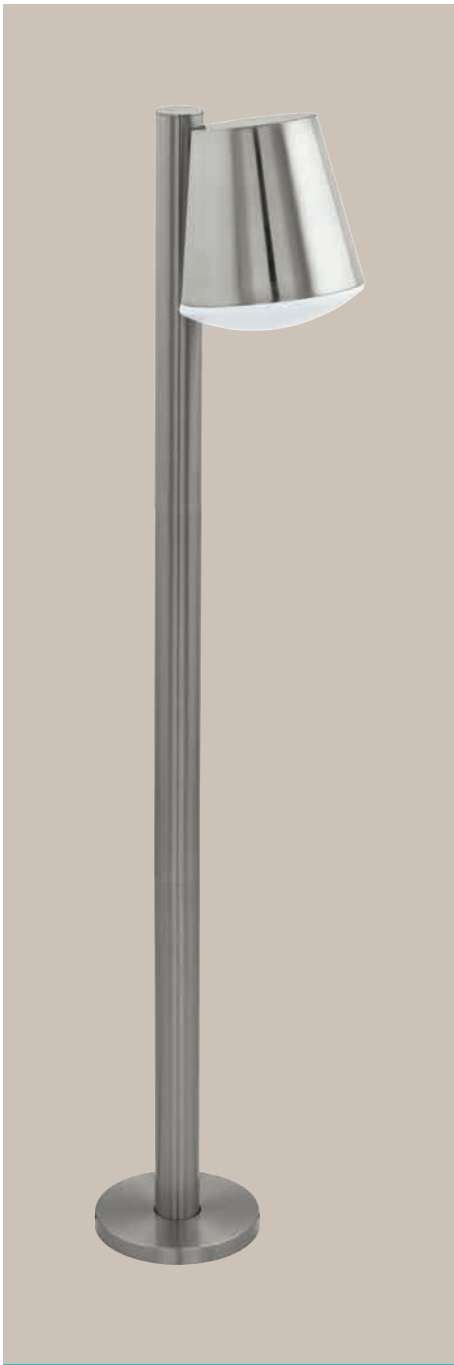

97454 CALDIERO

floor luminaire; stainless steel, stainless steel / plastic, white
 Stehleuchte; Edelstahl, edelstahl / Kunststoff, weiss
 lampadaire; acier inoxydable, acier inoxydable / plastique, blanc

L 240, B 140, H 965, Base: Ø 140

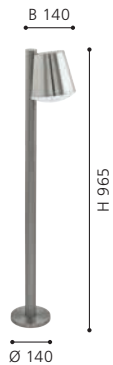

97452 CALDIERO

wall luminaire; stainless steel, stainless steel / plastic, white
 Wandleuchte; Edelstahl, edelstahl / Kunststoff, weiss
 applique; acier inoxydable, acier inoxydable / plastique, blanc

L 140, H 240, A 185



90°, 6 m
 10 sec. - 10 min.

**SAFETY &
 COMFORT**

97453 CALDIERO

wall luminaire; stainless steel, stainless steel / plastic, white
 Wandleuchte; Edelstahl, edelstahl / Kunststoff, weiss
 applique; acier inoxydable, acier inoxydable / plastique, blanc

L 140, H 240, A 185

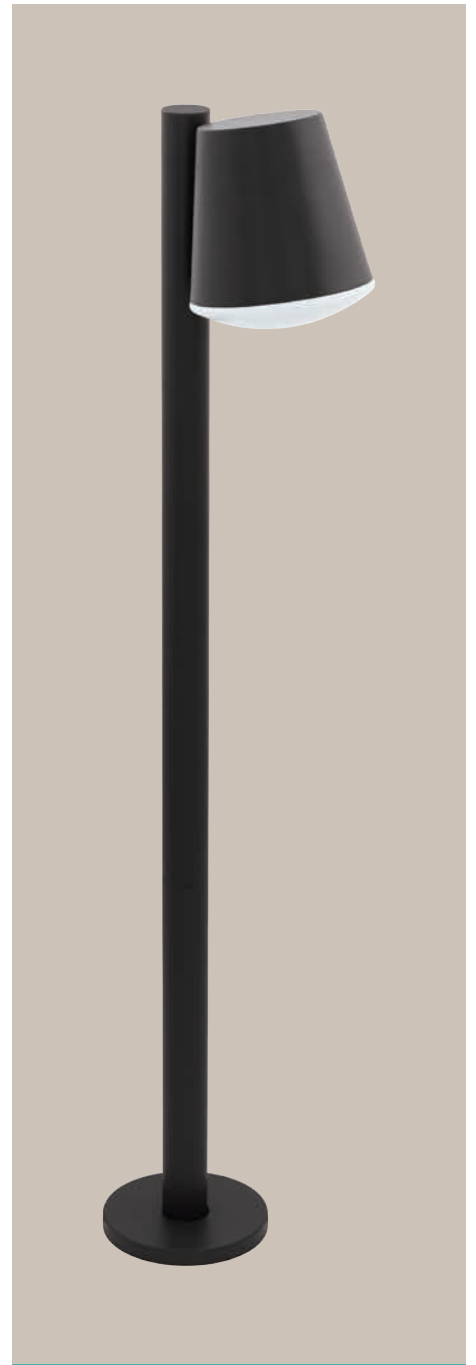

97147 CALDIERO

floor luminaire; zinc-plated steel, anthracite / plastic, white
 Stehleuchte; Stahl verzinkt, anthrazit / Kunststoff, weiss
 lampadaire; acier galvanisé, anthracite / plastique, blanc

L 240, B 140, H 965, Base: Ø 140

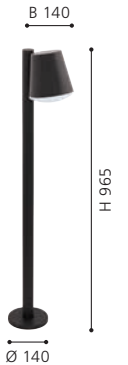



97146 CALDIERO

wall luminaire; zinc-plated steel, anthracite / plastic, white
Wandleuchte; Stahl verzinkt, anthrazit / Kunststoff, weiss
applique; acier galvanisé, anthracite / plastique, blanc

L 140, H 240, A 185



97451 CALDIERO

wall luminaire; zinc-plated steel, anthracite / plastic, white
Wandleuchte; Stahl verzinkt, anthrazit / Kunststoff, weiss
applique; acier galvanisé, anthracite / plastique, blanc

L 140, H 240, A 185

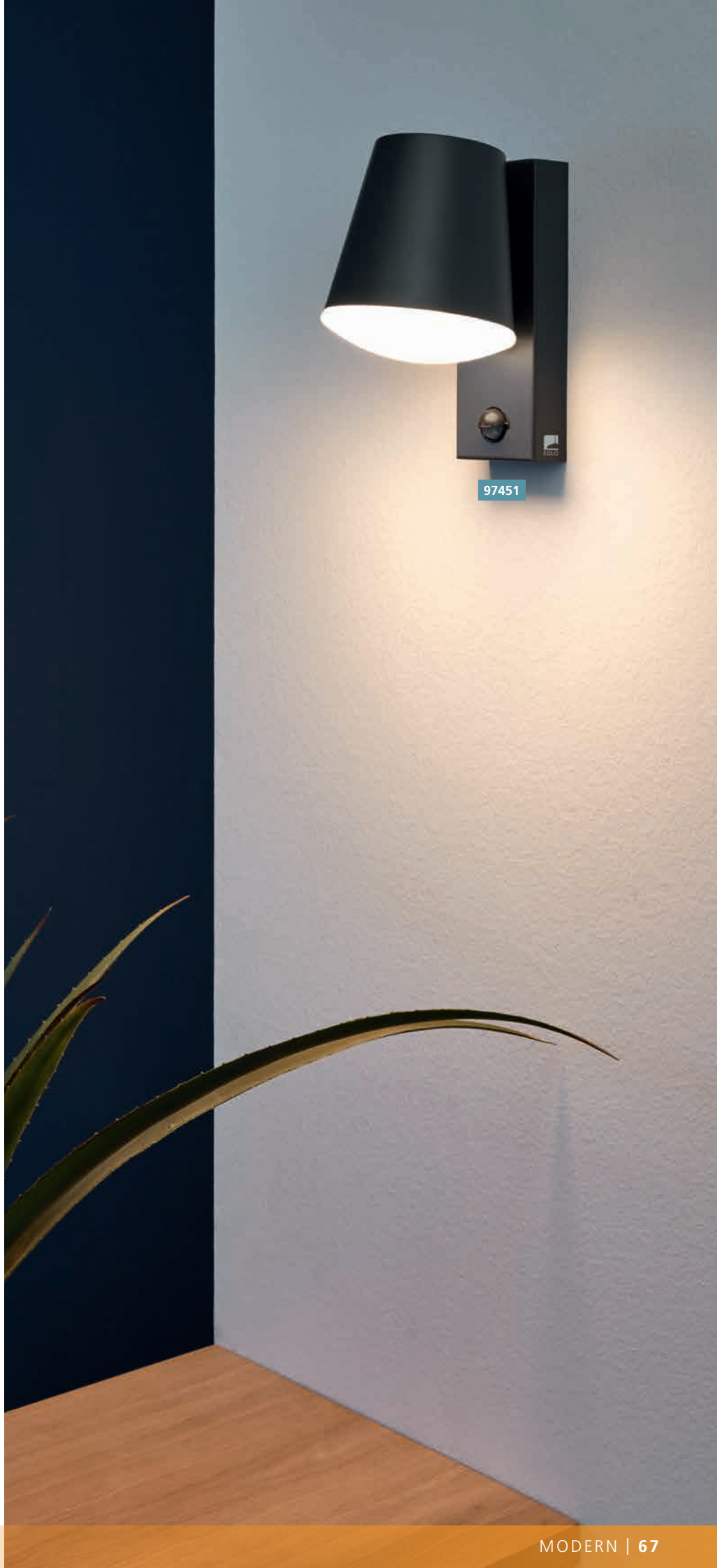

97451



94811 PENALVA

wall luminaire; stainless steel, stainless steel / plastic, clear, white
 Wandleuchte; Edelstahl, edelstahl / Kunststoff, klar, weiss
 applique; acier inoxydable, acier inoxydable / plastique, clair, blanc

L 75, H 225, A 110



94812 PENALVA

wall luminaire; stainless steel, stainless steel / plastic, clear, white
 Wandleuchte; Edelstahl, edelstahl / Kunststoff, klar, weiss
 applique; acier inoxydable, acier inoxydable / plastique, clair, blanc

L 75, H 335, A 110

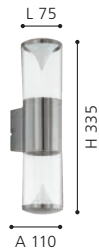

PENALVA

With direkt and/or indirect light this luminaire create a spectacular effect.

Diese Leuchten schaffen durch direktes und/oder indirektes Licht einen tollen Effekt.

Ce luminaire créé un effets lumineux special pour une illumination direct et/ou indirect.



94812



96013 ROBLEDO

wall luminaire; stainless steel, stainless steel / plastic, transparent
 Wandleuchte; Edelstahl, edelstahl / Kunststoff, transparent
 applique; acier inoxydable, acier inoxydable / plastique, transparent

L 75, H 260, A 120

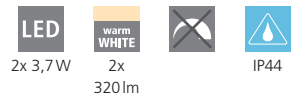

93268 STOCKHOLM 1

wall luminaire; stainless steel, stainless steel / glass, clear
 Wandleuchte; Edelstahl, edelstahl / Glas, klar
 applique; acier inoxydable, acier inoxydable / verre, clair

Ø 100

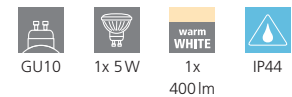

96013



97844 MERLITO

wall luminaire; zinc-plated steel, anthracite / plastic, white
Wandleuchte; Stahl verzinkt, anthrazit / Kunststoff, weiss
applique; acier galvanisé, anthracite / plastique, blanc

L 115, H 185, A 155

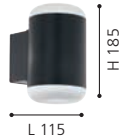

97843 MERLITO

wall luminaire; stainless steel, stainless steel / plastic, white
Wandleuchte; Edelstahl, edelstahl / Kunststoff, weiss
applique; acier inoxydable, acier inoxydable / plastique, blanc

L 115, H 185, A 155

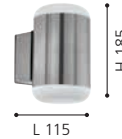

92736 RIGA-LED

wall luminaire; stainless steel, stainless steel / plastic, satin
Wandleuchte; Edelstahl, edelstahl / Kunststoff, satiniert
applique; acier inoxydable, acier inoxydable / plastique, satiné

L 65, H 205, A 95

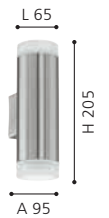
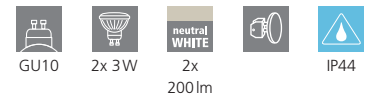

97844



86541 BEVERLY

wall luminaire; stainless steel, stainless steel, silver / satin glass, white
Wandleuchte; Edelstahl, edelstahl, silber / Glas satiniert, weiss
applique; acier inoxydable, acier inoxydable, argent / verre satiné, blanc

L 200, H 350, A 135

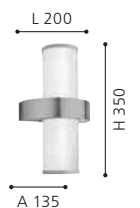







96505 RIGA-LED

wall luminaire; zinc-plated steel, black / plastic, satined
 Wandleuchte; Stahl verzinkt, schwarz / Kunststoff, satiniert
 applique; acier galvanisé, noir / plastique, satiné

L 65, H 205, A 100

-  GU10
-  2x 5W
-  neutral
WHITE
2x
400lm
-  IP44







9 002759 965051



96504 RIGA-LED

wall luminaire; zinc-plated steel, white / plastic, satined
 Wandleuchte; Stahl verzinkt, weiss / Kunststoff, satiniert
 applique; acier galvanisé, blanc / plastique, satiné

L 65, H 205, A 100

-  GU10
-  2x 5W
-  neutral
WHITE
2x
400lm
-  IP44



9 002759 965044





32898 RIGA 5

wall luminaire; stainless steel, stainless steel / glass, clear
Wandleuchte; Edelstahl, edelstahl / Glas, klar
applique; acier inoxydable, acier inoxydable / verre, clair

L 65, H 215, A 110

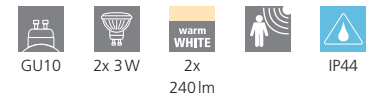

32899 RIGA 5

wall luminaire; zinc-plated steel, anthracite / glass, clear
Wandleuchte; Stahl verzinkt, anthrazit / Glas, klar
applique; acier galvanisé, anthracite / verre, clair

L 65, H 215, A 110

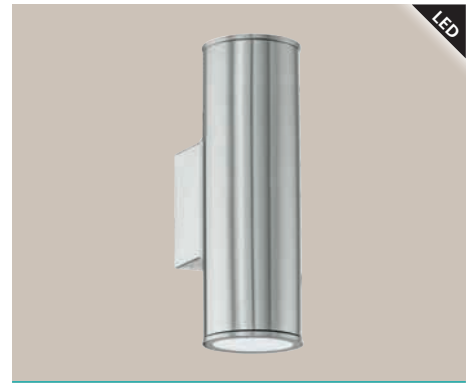
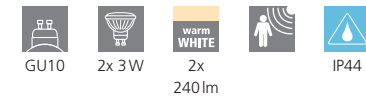

94107 RIGA

wall luminaire; stainless steel, stainless steel
Wandleuchte; Edelstahl, edelstahl
applique; acier inoxydable, acier inoxydable

L 65, H 200, A 95

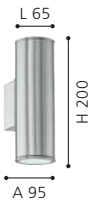
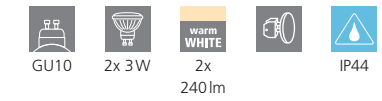

94107

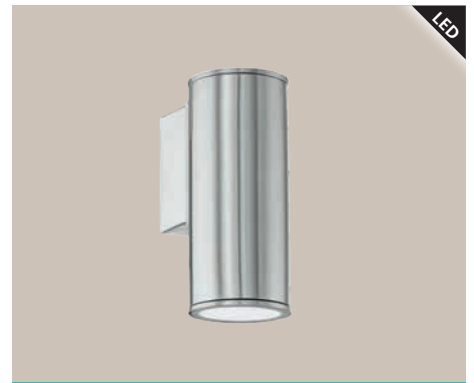

94106 RIGA

wall luminaire; stainless steel, stainless steel
Wandleuchte; Edelstahl, edelstahl
applique; acier inoxydable, acier inoxydable

L 65, H 150, A 95

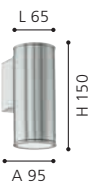



LED

94105 RIGA

wall luminaire; zinc-plated steel, antique-brown
Wandleuchte; Stahl verzinkt, antik-braun
applique; acier galvanisé, marron antique

L 65, H 200, A 95

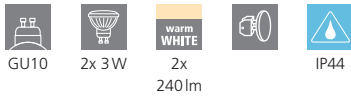

LED

94103 RIGA

wall luminaire; zinc-plated steel, anthracite
Wandleuchte; Stahl verzinkt, anthrazit
applique; acier galvanisé, anthracite

L 65, H 200, A 95

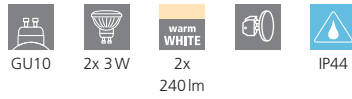

LED

94101 RIGA

wall luminaire; zinc-plated steel, white
Wandleuchte; Stahl verzinkt, weiss
applique; acier galvanisé, blanc

L 65, H 200, A 95

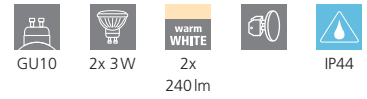

LED

94104 RIGA

wall luminaire; zinc-plated steel, antique-brown
Wandleuchte; Stahl verzinkt, antik-braun
applique; acier galvanisé, marron antique

L 65, H 150, A 95

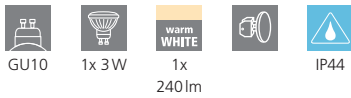

LED

94102 RIGA

wall luminaire; zinc-plated steel, anthracite
Wandleuchte; Stahl verzinkt, anthrazit
applique; acier galvanisé, anthracite

L 65, H 150, A 95

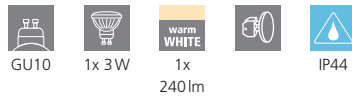

LED

94099 RIGA

wall luminaire; zinc-plated steel, white
Wandleuchte; Stahl verzinkt, weiss
applique; acier galvanisé, blanc

L 65, H 150, A 95





97119



97119 TONEGO

wall luminaire; zinc-plated steel, anthracite / plastic, white
Wandleuchte; Stahl verzinkt, anthrazit / Kunststoff, weiss
applique; acier galvanisé, anthracite / plastique, blanc

L 75, H 310, A 100



2x 6W



2x
500lm



IP44



9 002759 971199



A+





98085 CISTIENA

wall luminaire; stainless steel, stainless steel / plastic, white
Wandleuchte; Edelstahl, edelstahl / Kunststoff, weiss
applique; acier inoxydable, acier inoxydable / plastique, blanc

L 180, H 350, A 90



E27



2x 10W



IP44



9 002759 980856



98086 CISTIENA

wall luminaire; zinc-plated steel, anthracite / plastic, white
Wandleuchte; Stahl verzinkt, anthrazit / Kunststoff, weiss
applique; acier galvanisé, anthracite / plastique, blanc

L 180, H 350, A 90



E27



2x 10W



IP44



9 002759 980863



98086



97315 FAVRIA

wall luminaire; aluminium, silver / plastic, white
 Wandleuchte; Alu, silber / Kunststoff, weiss
 applique; aluminium, argent / plastique, blanc

L 125, H 185, A 115

LED
 1x 11W
warm WHITE
 1x
 1250lm
 IP44
 A+
 9 002759 973155
 L 125, H 185, A 115



97316 FAVRIA

wall luminaire; aluminium, anthracite / plastic, white
 Wandleuchte; Alu, anthrazit / Kunststoff, weiss
 applique; aluminium, anthracite / plastique, blanc

L 125, H 185, A 115

LED
 1x 11W
warm WHITE
 1x
 1250lm
 IP44
 A+
 9 002759 973162
 L 125, H 185, A 115



97314 FAVRIA 1

wall luminaire; aluminium, anthracite / plastic, white
 Wandleuchte; Alu, anthrazit / Kunststoff, weiss
 applique; aluminium, anthracite / plastique, blanc

L 125, H 260, A 115

LED
 2x 5,5W
warm WHITE
 2x
 650lm
 IP44
 A++
 9 002759 973148
 L 125, H 260, A 115



97313 FAVRIA 1

wall luminaire; aluminium, silver / plastic, white
 Wandleuchte; Alu, silber / Kunststoff, weiss
 applique; aluminium, argent / plastique, blanc

L 125, H 260, A 115

LED
 2x 5,5W
warm WHITE
 2x
 650lm
 IP44
 A++
 9 002759 973131
 L 125, H 260, A 115



97314



94128 TRONO STICK

wall luminaire; stainless steel, stainless steel / glass, plastic, clear
 Wandleuchte; Edelstahl, edelstahl / Glas, Kunststoff, klar
 applique; acier inoxydable, acier inoxydable / verre, plastique, clair

L 105, H 410, A 175

- GU10
 1x 3W
 warm WHITE
 LED
 1x 240lm
- IP44



94127 TRONO STICK

wall luminaire; stainless steel, stainless steel / glass, plastic, clear
 Wandleuchte; Edelstahl, edelstahl / Glas, Kunststoff, klar
 applique; acier inoxydable, acier inoxydable / verre, plastique, clair

L 105, H 350, A 115

- GU10
 1x 3W
 warm WHITE
 LED
 1x 280lm
- IP44



97284 TRIBANO

wall luminaire; zinc-plated steel, stainless steel / plastic, transparent
 Wandleuchte; Stahl verzinkt, edelstahl / Kunststoff, transparent
 applique; acier galvanisé, acier inoxydable / plastique, transparent

L 200, H 260, A 100

- E27
 1x 60W

 IP44



30173 DARIL

wall luminaire; stainless steel, stainless steel / plastic, clear
 Wandleuchte; Edelstahl, edelstahl / Kunststoff, klar
 applique; acier inoxydable, acier inoxydable / plastique, clair

L 195, H 240, A 110

- E27
 1x 60W
 IP44





90°, 7 m
10 sec. - 4 min.

**SAFETY &
COMFORT**

97238 VERRES

wall luminaire; stainless steel, plastic, stainless steel, white / plastic, white
Wandleuchte; Edelstahl, Kunststoff, edelstahl, weiss / Kunststoff, weiss
applique; acier inoxydable, plastique, acier inoxydable, blanc / plastique, blanc

L 180, H 290, A 90



180°, 7 m
10 sec. - 15 min.

**SAFETY &
COMFORT**

97218 MUSSOTTO

wall luminaire; stainless steel, plastic, stainless steel, white / plastic, white
Wandleuchte; Edelstahl, Kunststoff, edelstahl, weiss / Kunststoff, weiss
applique; acier inoxydable, plastique, acier inoxydable, blanc / plastique, blanc

L 210, H 305, A 90



120°, 6 m
10 sec. - 8 min.

**SAFETY &
COMFORT**

97159 AZZINANO

wall luminaire; zinc-plated steel, silver / plastic, white
Wandleuchte; Stahl verzinkt, silber / Kunststoff, weiss
applique; acier galvanisé, argent / plastique, blanc

L 185, H 115, A 125

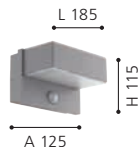

96237 OROPOS

wall luminaire; zinc-plated steel, silver / plastic, white
Wandleuchte; Stahl verzinkt, silber / Kunststoff, weiss
applique; acier galvanisé, argent / plastique, blanc

Ø 250, A 75



1x A-F 3x 0-9

OROPOS

Letters and numbers included in delivery.

Buchstaben und Zahlen im Lieferumfang enthalten.

Les lettres et les nombres sont inclus dans la livraison.



96491 ARGOLIS

wall / ceiling luminaire; cast aluminium, white / plastic, white

Wand- / Deckenleuchte; Aluguss, weiss / Kunststoff, weiss

applique / plafonnier; fonte d'aluminium, blanc / plastique, blanc

H 35, Ø 225



16,5W 1600lm

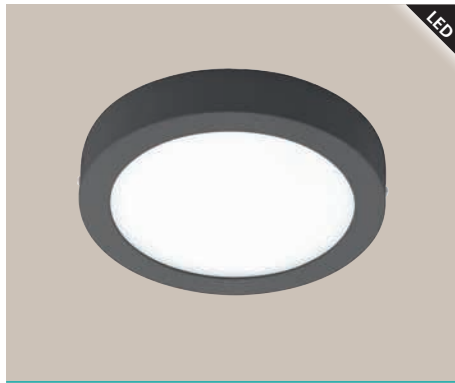

96492 ARGOLIS

wall / ceiling luminaire; cast aluminium, anthracite / plastic, white

Wand- / Deckenleuchte; Aluguss, anthrazit / Kunststoff, weiss

applique / plafonnier; fonte d'aluminium, anthracite / plastique, blanc

H 35, Ø 225



16,5W 1600lm



96365 VENTO 2

wall / ceiling luminaire; stainless steel, stainless steel / plastic, white

Wand- / Deckenleuchte; Edelstahl, edelstahl / Kunststoff, weiss

applique / plafonnier; acier inoxydable, acier inoxydable / plastique, blanc

Ø 185, A 70



1x 5,4W 1x 410lm



94785 ONTANEDA

wall / ceiling luminaire; plastic, white / plastic, white

Wand- / Deckenleuchte; Kunststoff, weiss / Kunststoff, weiss

applique / plafonnier; plastique, blanc / plastique, blanc

Ø 325, A 75



8,2W 820lm



94784 ONTANEDA

wall / ceiling luminaire; plastic, black / plastic, white

Wand- / Deckenleuchte; Kunststoff, schwarz / Kunststoff, weiss

applique / plafonnier; plastique, noir / plastique, blanc

Ø 325, A 75



8,2W 820lm



94121 VENTO 1

wall / ceiling luminaire; stainless steel, stainless steel / glass, white painted

Wand- / Deckenleuchte; Edelstahl, edelstahl / Glas, weiss lackiert

applique / plafonnier; acier inoxydable, acier inoxydable / verre, blanc laqué

Ø 285, A 80



11W 950lm





94785



97255 PILONE

wall / ceiling luminaire; steel, plastic, black / plastic, white
Wand- / Deckenleuchte; Stahl, Kunststoff, schwarz / Kunststoff, weiss
applique / plafonnier; acier, plastique, noir / plastique, blanc

H 70, Ø 300



1x 11 W



1x
950 lm



IP44



9 002759 972554



Ø 300



A+



97254 PILONE

wall / ceiling luminaire; steel, plastic, white / plastic, white
Wand- / Deckenleuchte; Stahl, Kunststoff, weiss / Kunststoff, weiss
applique / plafonnier; acier, plastique, blanc / plastique, blanc

H 70, Ø 300



1x 11 W



1x
950 lm



IP44



9 002759 972547



Ø 300



A+



96021 SESIMBA 1

wall luminaire; zinc-plated steel, black / plastic, clear
Wandleuchte; Stahl verzinkt, schwarz / Kunststoff, klar
applique; acier galvanisé, noir / plastique, clair

L 130, H 195, A 140

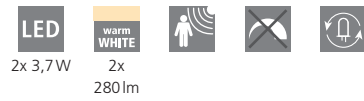

96019 SESIMBA 1

wall luminaire; zinc-plated steel, silver / plastic, clear
Wandleuchte; Stahl verzinkt, silber / Kunststoff, klar
applique; acier galvanisé, argent / plastique, clair

L 130, H 195, A 140



96022 SESIMBA 1

wall luminaire; zinc-plated steel, white / plastic, clear
Wandleuchte; Stahl verzinkt, weiss / Kunststoff, klar
applique; acier galvanisé, blanc / plastique, clair

L 130, H 195, A 140



94848 SESIMBA

wall luminaire; zinc-plated steel, black / plastic, clear
Wandleuchte; Stahl verzinkt, schwarz / Kunststoff, klar
applique; acier galvanisé, noir / plastique, clair

L 130, H 195, A 140



94796 SESIMBA

wall luminaire; zinc-plated steel, silver / plastic, clear
Wandleuchte; Stahl verzinkt, silber / Kunststoff, klar
applique; acier galvanisé, argent / plastique, clair

L 130, H 195, A 140





96019

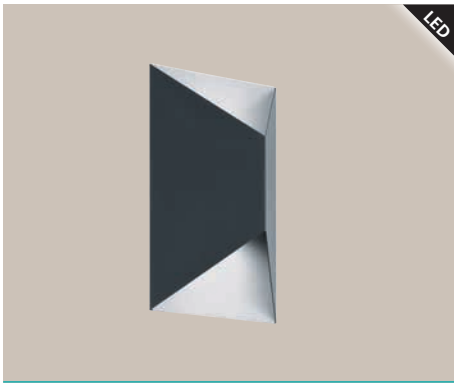

LED

93994 PREDAZZO

wall luminaire; zinc-plated steel, anthracite, white
Wandleuchte; Stahl verzinkt, anthrazit, weiss
applique; acier galvanisé, anthracite, blanc

L 140, H 210, A 75



LED

93319 MORINO

wall luminaire; cast aluminium, anthracite
Wandleuchte; Aluguss, anthrazit
applique; fonte d'aluminium, anthracite

L 140, H 180, A 105

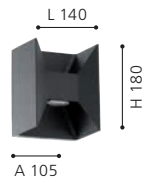

LED

93318 MORINO

wall luminaire; cast aluminium, white
Wandleuchte; Aluguss, weiss
applique; fonte d'aluminium, blanc

L 140, H 180, A 105

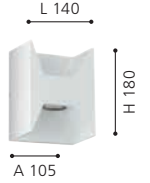

LED

97222 GORZANO

wall luminaire; zinc-plated steel, anthracite / plastic, satined
Wandleuchte; Stahl verzinkt, anthrazit / Kunststoff, satiniert
applique; acier galvanisé, anthracite / plastique, satiné

L 80, H 290, A 105

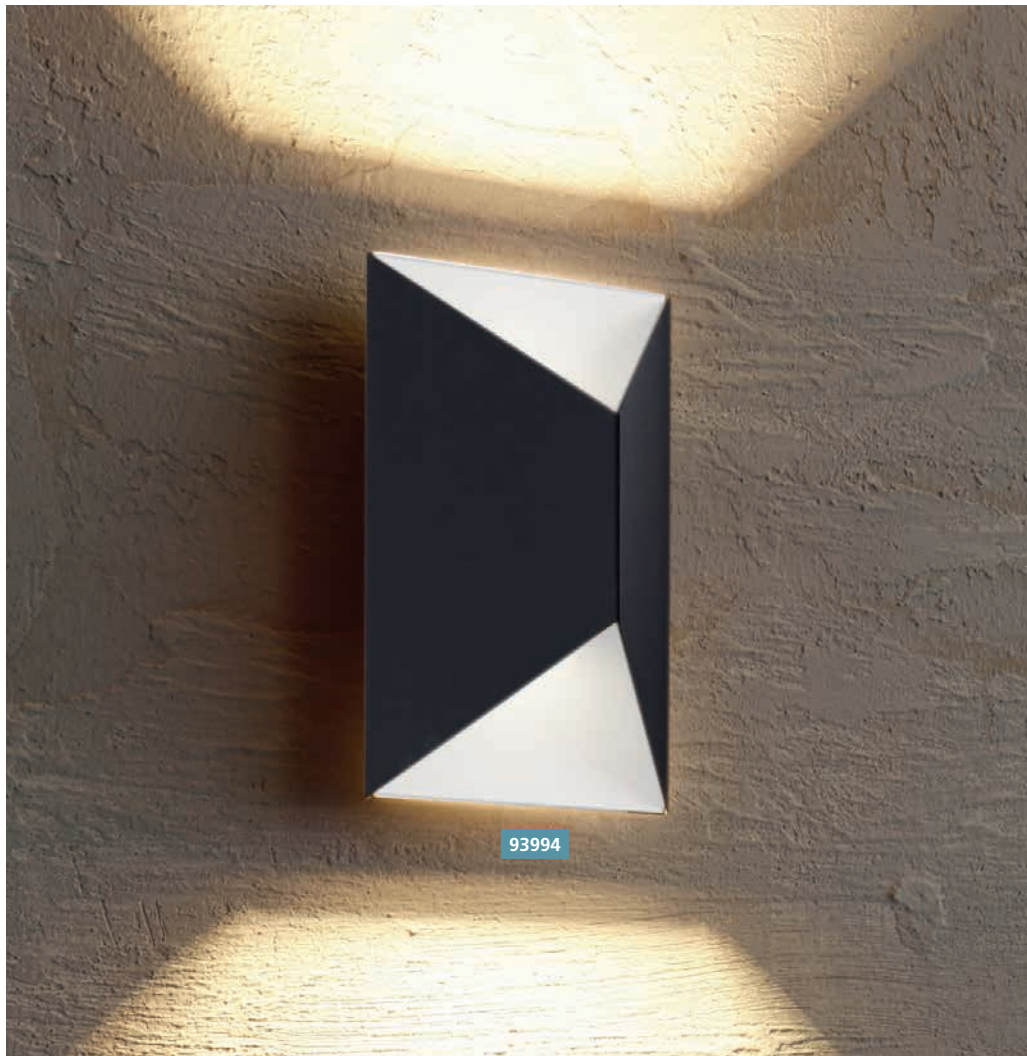

93994



93367 REDONDO

wall luminaire; cast aluminium, white
 Wandleuchte; Aluguss, weiss
 applique; fonte d'aluminium, blanc

L 160, H 175, A 125

LED
 2x 2,5W
 warm WHITE
 2x
 180lm
 IP44



9 002759 933678

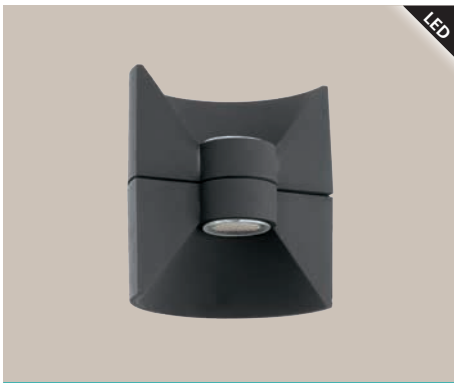

93368 REDONDO

wall luminaire; cast aluminium, anthracite
 Wandleuchte; Aluguss, anthrazit
 applique; fonte d'aluminium, anthracite

L 160, H 175, A 125

LED
 2x 2,5W
 warm WHITE
 2x
 180lm
 IP44



9 002759 933685



93367

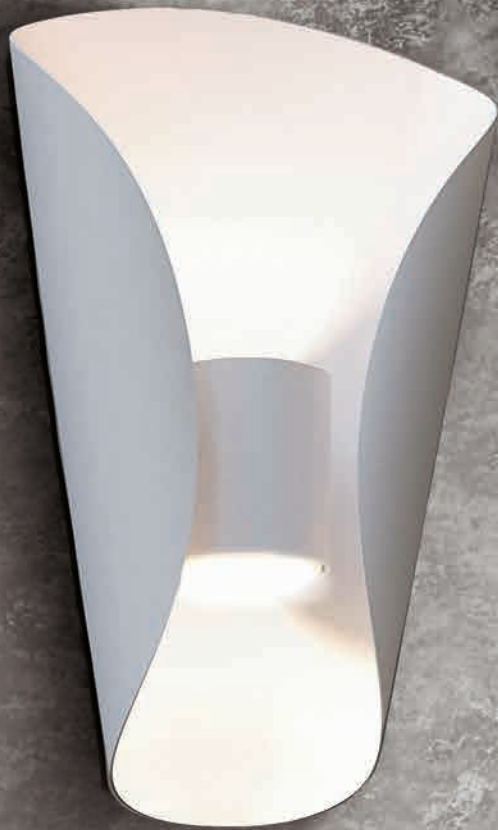

93991



93991 BOSARO

wall luminaire; zinc-plated steel, white
Wandleuchte; Stahl verzinkt, weiss
applique; acier galvanisé, blanc

L 170, H 270, A 105



94779 BOSARO

wall luminaire; stainless steel, stainless steel
Wandleuchte; Edelstahl, edelstahl
applique; acier inoxydable, acier inoxydable

L 170, H 270, A 105



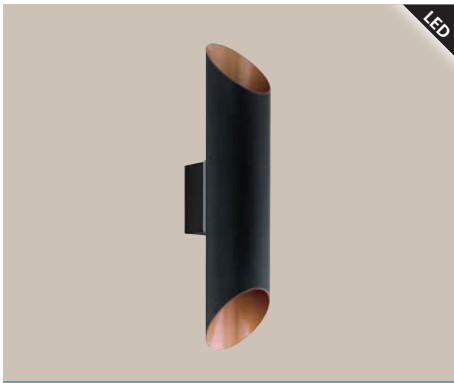

94804 AGOLADA

wall luminaire; zinc-plated steel, black, copper
Wandleuchte; Stahl verzinkt, schwarz, kupfer
applique; acier galvanisé, noir, cuivre

L 75, H 360, A 110

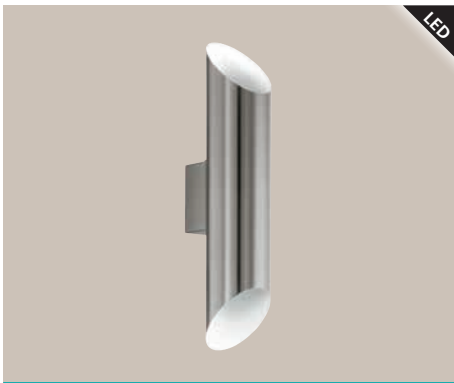

94803 AGOLADA

wall luminaire; stainless steel, stainless steel, white
Wandleuchte; Edelstahl, edelstahl, weiss
applique; acier inoxydable, acier inoxydable, blanc

L 75, H 360, A 110

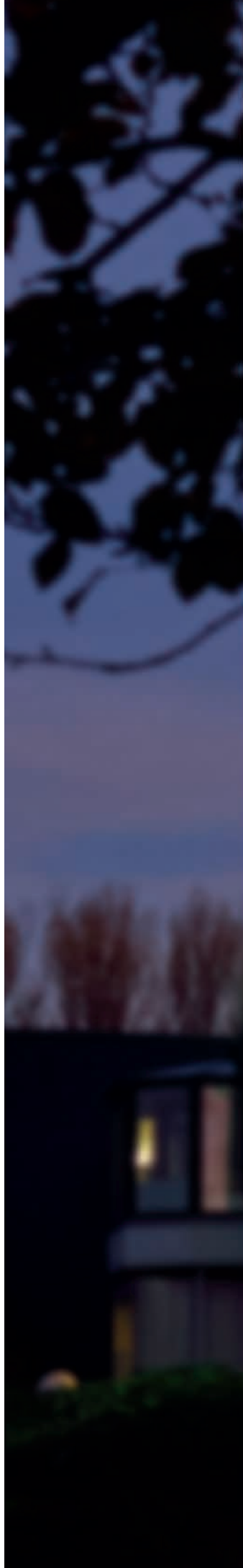
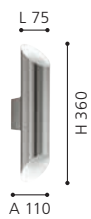

94803



96255



96256 JORBA

wall luminaire; cast aluminium, anthracite / plastic, white
Wandleuchte; Aluguss, anthrazit / Kunststoff, weiss
applique; fonte d'aluminium, anthracite / plastique, blanc

L 110, H 110, A 110

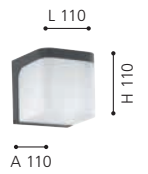

96255 JORBA

wall luminaire; cast aluminium, white / plastic, white
Wandleuchte; Aluguss, weiss / Kunststoff, weiss
applique; fonte d'aluminium, blanc / plastique, blanc

L 110, H 110, A 110

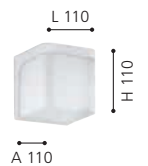



96007



96007 PERAFITA

wall luminaire; cast aluminium, anthracite / plastic, white
Wandleuchte; Aluguss, anthrazit / Kunststoff, weiss
applique; fonte d'aluminium, anthracite / plastique, blanc

L 175, H 170, A 95



2x 6W



2x
500lm



IP44



9 002759 960070



96006 PERAFITA

wall luminaire; cast aluminium, white / plastic, white
Wandleuchte; Aluguss, weiss / Kunststoff, weiss
applique; fonte d'aluminium, blanc / plastique, blanc

L 175, H 170, A 95



2x 6W



2x
500lm



IP44



9 002759 960063

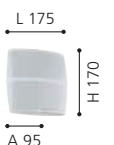



94871 SONELLA

wall / ceiling luminaire; plastic, white / plastic, white
 Wand- / Deckenleuchte; Kunststoff, weiss / Kunststoff, weiss
 applique / plafonnier; plastique, blanc / plastique, blanc
 L 215, B 215, A 70



94872 SONELLA

wall / ceiling luminaire; plastic, anthracite / plastic, white
 Wand- / Deckenleuchte; Kunststoff, anthrazit / Kunststoff, weiss
 applique / plafonnier; plastique, anthracite / plastique, blanc
 L 215, B 215, A 70



96494 ARGOLIS

wall / ceiling luminaire; cast aluminium, white / plastic, white
 Wand- / Deckenleuchte; Aluguss, weiss / Kunststoff, weiss
 applique / plafonnier; fonte d'aluminium, blanc / plastique, blanc
 L 300, B 300, H 40



96495



96495 ARGOLIS

wall / ceiling luminaire; cast aluminium, anthracite / plastic, white
 Wand- / Deckenleuchte; Aluguss, anthrazit / Kunststoff, weiss
 applique / plafonnier; fonte d'aluminium, anthracite / plastique, blanc
 L 300, B 300, H 40





ET2173

94877 INFESTO 1

wall / ceiling luminaire; stainless steel, plastic, stainless steel,
silver / plastic, white

Wand- / Deckenleuchte; Edelstahl, Kunststoff, edelstahl, silber /
Kunststoff, weiss

applique / plafonnier; acier inoxydable, plastique, acier inoxy-
dable, argent / plastique, blanc

L 250, H 250, A 70

LED

8,2W

warm
WHITE

820lm



IP44



9 002759 948771

A+

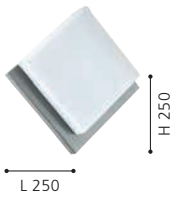

94877



95987



95988 SITIA

wall luminaire; zinc-plated steel, anthracite / plastic, white
Wandleuchte; Stahl verzinkt, anthrazit / Kunststoff, weiss
applique; acier galvanisé, anthracite / plastique, blanc

L 180, H 180, A 55

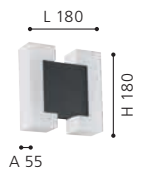

95987 SITIA

wall luminaire; zinc-plated steel, satin nickel / plastic, white
Wandleuchte; Stahl verzinkt, nickel-matt / Kunststoff, weiss
applique; acier galvanisé, nickel mat / plastique, blanc

L 180, H 180, A 55

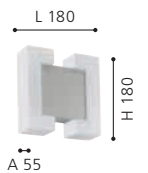



93254 KIBEA

wall luminaire; zinc-plated steel, white, anthracite
Wandleuchte; Stahl verzinkt, weiss, anthrazit
applique; acier galvanisé, blanc, anthracite

L 150, H 260, A 75



2x 2,5W 2x 180lm



9 002759 932541



A 75



93438 NADELA

wall luminaire; stainless steel, stainless steel / satin glass, white
Wandleuchte; Edelstahl, edelstahl / Glas satiniert, weiss
applique; acier inoxydable, acier inoxydable / verre satiné, blanc

L 215, H 290, A 90



2x 2,5W 2x 180lm

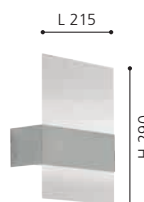

9 002759 934385



A 90

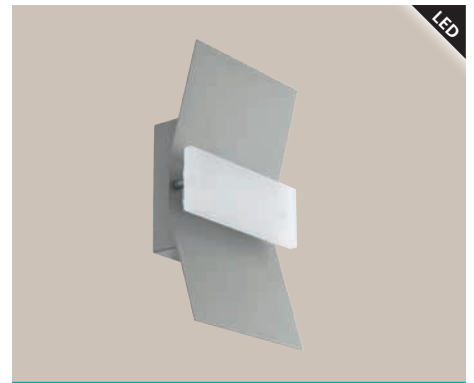

97158 BINASCO

wall luminaire; zinc-plated steel, silver / plastic, satiné
Wandleuchte; Stahl verzinkt, silber / Kunststoff, satiniert
applique; acier galvanisé, argent / plastique, satiné

L 180, H 300, A 60



1x 4,8W 1x 500lm

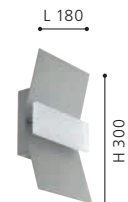

9 002759 971588



A 60



97158



LED

94138 BREGANZO

wall luminaire; zinc-plated steel, anthracite / plastic, white
Wandleuchte; Stahl verzinkt, anthrazit / Kunststoff, weiss
applique; acier galvanisé, anthracite / plastique, blanc

L 180, H 250, A 115



LED

94137 BREGANZO

wall luminaire; zinc-plated steel, silver / plastic, white
Wandleuchte; Stahl verzinkt, silber / Kunststoff, weiss
applique; acier galvanisé, argent / plastique, blanc

L 180, H 250, A 115



LED



90°, 6 m
10 sec. - 10 min.

SAFETY &
COMFORT

96018 BREGANZO 1

wall luminaire; zinc-plated steel, anthracite / plastic, white
Wandleuchte; Stahl verzinkt, anthrazit / Kunststoff, weiss
applique; acier galvanisé, anthracite / plastique, blanc

L 190, H 300, A 125



GL-803

83433 PARK

wall luminaire; cast aluminium, anthracite / satin glass, white
Wandleuchte; Aluguss, anthrazit / Glas satiniert, weiss
applique; fonte d'aluminium, anthracite / verre satiné, blanc

L 200, H 350, A 145

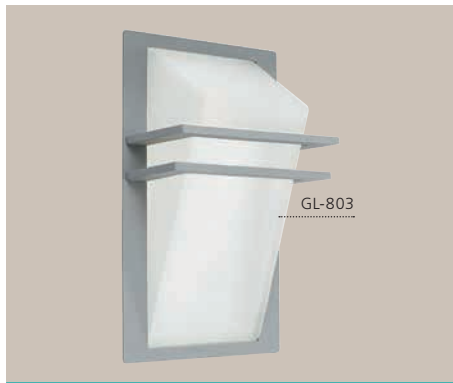

GL-803

83432 PARK

wall luminaire; cast aluminium, silver / satin glass, white
Wandleuchte; Aluguss, silber / Glas satiniert, weiss
applique; fonte d'aluminium, argent / verre satiné, blanc

L 200, H 350, A 145



LED



90°, 6 m
10 sec. - 10 min.

SAFETY &
COMFORT

96017 BREGANZO 1

wall luminaire; zinc-plated steel, silver / plastic, white
Wandleuchte; Stahl verzinkt, silber / Kunststoff, weiss
applique; acier galvanisé, argent / plastique, blanc

L 190, H 300, A 125

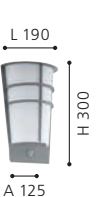



96017



30191 CERNO

wall luminaire; stainless steel, stainless steel / satin glass, white
Wandleuchte; Edelstahl, edelstahl / Glas satiniert, weiss
applique; acier inoxydable, acier inoxydable / verre satiné, blanc

L 140, H 165, A 105



88144 CITY

wall luminaire; stainless steel, stainless steel / plastic, white
Wandleuchte; Edelstahl, edelstahl / Kunststoff, weiss
applique; acier inoxydable, acier inoxydable / plastique, blanc

L 235, H 260, A 90

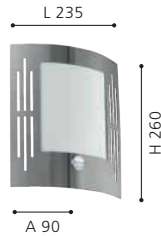

88142 CITY

wall luminaire; stainless steel, stainless steel / plastic, white
Wandleuchte; Edelstahl, edelstahl / Kunststoff, weiss
applique; acier inoxydable, acier inoxydable / plastique, blanc

L 235, H 260, A 90



30192 CERNO

wall luminaire; stainless steel, stainless steel / satin glass, white
Wandleuchte; Edelstahl, edelstahl / Glas satiniert, weiss
applique; acier inoxydable, acier inoxydable / verre satiné, blanc

L 140, H 190, A 110

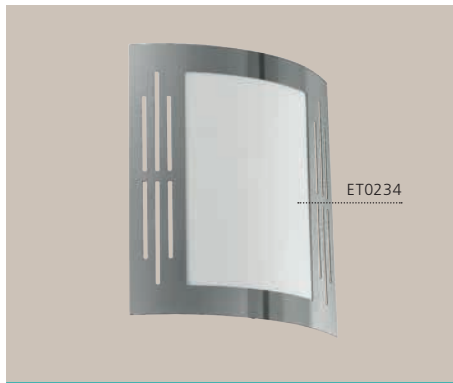

82309 CITY

wall luminaire; stainless steel, stainless steel / plastic, white
Wandleuchte; Edelstahl, edelstahl / Kunststoff, weiss
applique; acier inoxydable, acier inoxydable / plastique, blanc

L 235, H 260, A 90

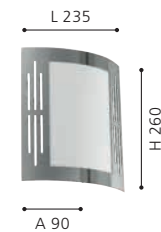

88139 CITY

wall luminaire; stainless steel, stainless steel / plastic, white
Wandleuchte; Edelstahl, edelstahl / Kunststoff, weiss
applique; acier inoxydable, acier inoxydable / plastique, blanc

L 235, H 260, A 90

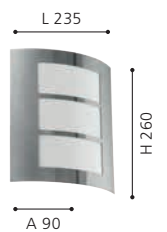



30192



95989 RALORA 1

wall luminaire; stainless steel, stainless steel / plastic, white
 Wandleuchte; Edelstahl, edelstahl / Kunststoff, weiss
 applique; acier inoxydable, acier inoxydable / plastique, blanc

L 170, H 290, A 100



94086 RALORA

wall luminaire; stainless steel, stainless steel / plastic, white
 Wandleuchte; Edelstahl, edelstahl / Kunststoff, weiss
 applique; acier inoxydable, acier inoxydable / plastique, blanc

L 140, H 240, A 70



94845 ACATE

wall / ceiling luminaire; aluminium, steel, silver / plastic, white
 Wand- / Deckenleuchte; Alu, Stahl, silber / Kunststoff, weiss
 applique / plafonnier; aluminium, acier, argent / plastique, blanc

L 100, H 350, A 60

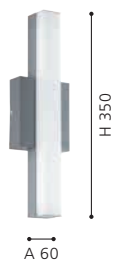

94186 TABO

wall luminaire; aluminium, silver
 Wandleuchte; Alu, silber
 applique; aluminium, argent

L 75, B 75, H 195, A 105





93365 PIAS

wall luminaire; stainless steel, stainless steel
 Wandleuchte; Edelstahl, edelstahl
 applique; acier inoxydable, acier inoxydable

L 150, H 250, A 55

LED
 2x 2,5W
 warm WHITE
 2x
 160lm
 IP44



9 002759 933654

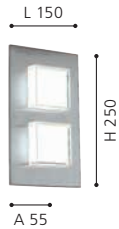

93364 TABO-LED

wall luminaire; stainless steel, stainless steel
 Wandleuchte; Edelstahl, edelstahl
 applique; acier inoxydable, acier inoxydable

L 80, H 195, A 110

LED
 2x 2,5W
 warm WHITE
 2x
 160lm
 IP44



9 002759 933647



94114 CALGARY 1

wall luminaire; stainless steel, stainless steel / plastic, white
 Wandleuchte; Edelstahl, edelstahl / Kunststoff, weiss
 applique; acier inoxydable, acier inoxydable / plastique, blanc

L 200, H 200, A 95

LED
 1x 3,7W
 warm WHITE
 1x
 320lm
 IP44



9 002759 941147

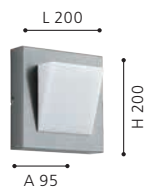



GL-859

88489 MILTON

wall luminaire; steel, zinc-plated / glass, clear
Wandleuchte; Stahl, feuerverzinkt / Glas, klar
applique; acier, galvanisé à chaud / verre, clair

H 310, A 310



GL1611

88119 SEVILLA

wall / ceiling luminaire; steel, zinc-plated / satin glass, white
Wand- / Deckenleuchte; Stahl, feuerverzinkt / Glas satiniert, weiss
applique / plafonnier; acier, galvanisé à chaud / verre satiné, blanc

Ø 285, A 83



96206 ENTRIMO

wall luminaire; zinc-plated steel, zinc-plated / plastic, white
Wandleuchte; Stahl verzinkt, feuerverzinkt / Kunststoff, weiss
applique; acier galvanisé, galvanisé à chaud / plastique, blanc

L 200, H 185, A 235



ET1602

90867 LEPUS

wall luminaire; steel, zinc-plated / plastic, white
Wandleuchte; Stahl, feuerverzinkt / Kunststoff, weiss
applique; acier, galvanisé à chaud / plastique, blanc

L 235, H 120, A 125





**15
YEARS
GUARANTEE**

88119

**88489, 88119,
96206, 90867**

15 years guarantee
against corrosion
on the hot dipped
galvanized surface.

15 Jahre Garantie
gegen Korrosion
der feuerverzinkten
Oberfläche.

Garantie de 15 ans
contre la corrosion
de surface galvanisé
à chaud.



GL2440



GL2440

89768 ONJA

wall luminaire; cast aluminium, white / glass fluted, clear
Wandleuchte; Aluguss, weiss / Glas geriffelt, klar
applique; fonte d'aluminium, blanc / verre cannelé, clair

L 220, H 155, A 150

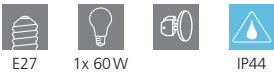

E27

1x 60W

IP44



9 002759 897680



89767 ONJA

wall luminaire; cast aluminium, black / glass fluted, clear
Wandleuchte; Aluguss, schwarz / Glas geriffelt, klar
applique; fonte d'aluminium, noir / verre cannelé, clair

L 220, H 155, A 150

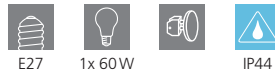

E27

1x 60W

IP44



9 002759 897673



89768



ONJA

With direkt and indirect light this luminaire create a spectacular effect.

Diese Leuchten schaffen durch direktes und indirektes Licht einen tollen Effekt.

Ce luminaire créé un effets lumineux special pour une illumination direct et indirect.



96583 LORMES

wall luminaire; plastic, white / plastic, white
Wandleuchte; Kunststoff, weiss / Kunststoff, weiss
applique; plastique, blanc / plastique, blanc

L 150, H 195, A 165



96584 LORMES

wall luminaire; plastic, black / plastic, clear
Wandleuchte; Kunststoff, schwarz / Kunststoff, klar
applique; plastique, noir / plastique, clair

L 150, H 195, A 165



88802 ANOLA

wall / ceiling luminaire; plastic, black / glass, clear
Wand- / Deckenleuchte; Kunststoff, schwarz / Glas, klar
applique / plafonnier; plastique, noir / verre, clair

L 203, B 113, A 94



TOPLINE

TOPLINE - Purist design and high quality materials characterize the exterior lighting program for extraordinary expectations. We are supporting the architecture that creates wellness spaces. Treat yourself to the topline of EGLO.

TOPLINE - Puristisches Design und Hochwertigkeit der Materialien zeichnen das Außenleuchten-Programm für gehobene Ansprüche besonders aus. Wir setzen damit Akzente für die Architektur des Wohlfühl-Raums. Gönnen Sie sich die Topline von EGLO.



TOPLINE - Conception puriste et matériaux de haute qualité caractérisent le programme d'éclairage extérieur pour les clients avec des attentes élevées. Nous avons donc donné le ton pour l'architecture de l'espace bien-être. Offrez-vous la Topline de EGLO.



OVERVIEW

TOPLINE





SAKEDA
108



SAKEDA
108



SAKEDA
108



GISOLA
109



GISOLA
109



GISOLA
109



PROPENDA
110



PROPENDA
110



PROPENDA
110



PROPENDA
110



ABRANTES
111



BELCREDA
112



BELCREDA
112



EMOLLIO
113



EMOLLIO
113



CALPINO
114



CALPINO
114



DESELLA 1
115



CANTZO
115



ROALES
116



ROALES
116



IPHIAS
117



IPHIAS
117



BEVERLY 1
118



BRIONES
118



CHEIRA
118

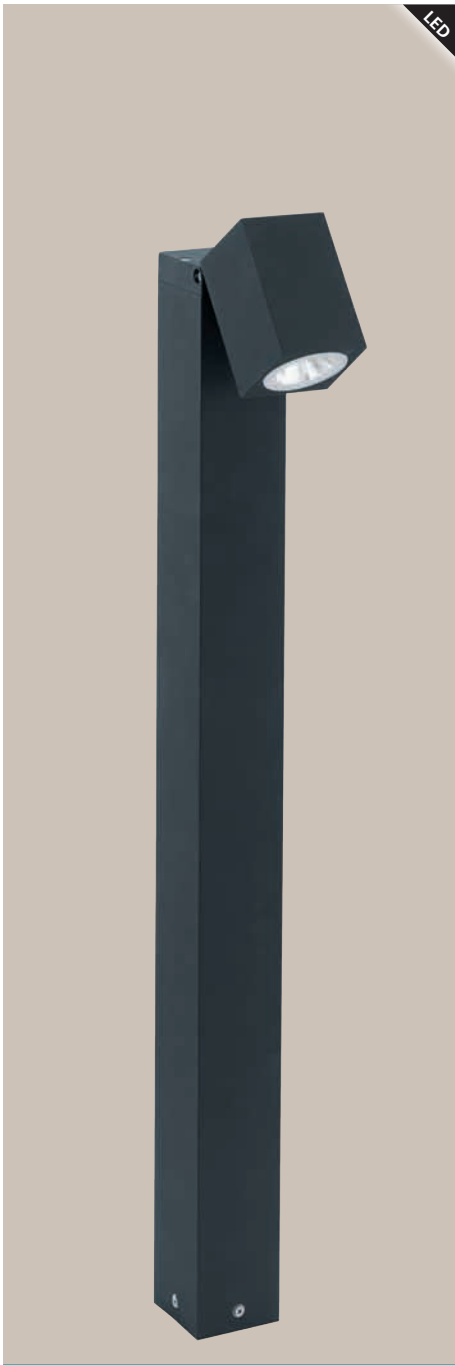

LED

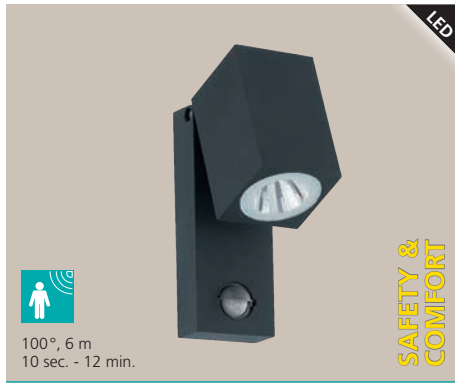

LED



100°, 6 m
10 sec. - 12 min.

SAFETY &
COMFORT



LED

96287 SAKEDA

wall luminaire; cast aluminium, anthracite
Wandleuchte; Aluguss, anthrazit
applique; fonte d'aluminium, anthracite

L 70, H 170, A 100



1x 5W



1x
650lm



IP44



9 002759 962876



96286 SAKEDA

wall luminaire; cast aluminium, anthracite
Wandleuchte; Aluguss, anthrazit
applique; fonte d'aluminium, anthracite

L 70, H 170, A 100



1x 5W



1x
650lm



IP44



9 002759 962869



96288 SAKEDA

floor luminaire; cast aluminium, anthracite
Stehleuchte; Aluguss, anthrazit
lampadaire; fonte d'aluminium, anthracite

L 135, B 70, H 780, Base: B 70, T 70



1x 5W



1x
650lm



IP44



9 002759 962883



96286



LED



LED

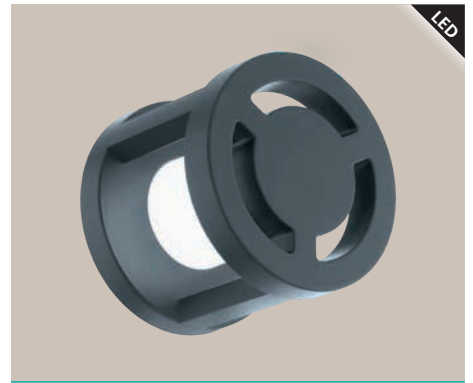

LED

97252 GISOLA

pedestal luminaire; cast aluminium, anthracite / plastic, satined
 Sockelleuchte; Aluguss, anthrazit / Kunststoff, satiniert
 luminaire pour socle; fonte d'aluminium, anthracite / plastique, satiné

H 450, Ø 150



1x 12W 1x 1000lm IP44



9 002759 972523



97251 GISOLA

wall / ceiling luminaire; cast aluminium, anthracite / plastic, satined
 Wand- / Deckenleuchte; Aluguss, anthrazit / Kunststoff, satiniert
 applique / plafonnier; fonte d'aluminium, anthracite / plastique, satiné

Ø 150, A 145



1x 12W 1x 1000lm IP44



9 002759 972516



97253 GISOLA

floor luminaire; cast aluminium, anthracite / plastic, satined
 Stehleuchte; Aluguss, anthrazit / Kunststoff, satiniert
 lampadaire; fonte d'aluminium, anthracite / plastique, satiné

H 1000, Ø 150



1x 12W 1x 1000lm IP44



9 002759 972530



97253



90°, 6 m
10 sec. - 5 min.

**SAFETY &
COMFORT**

96012 PROPENDA

floor luminaire; cast aluminium, anthracite / plastic, white
Stehleuchte; Aluguss, anthrazit / Kunststoff, weiss
lampadaire; fonte d'aluminium, anthracite / plastique, blanc

L 120, B 165, H 1035, Base: B 165, T 135



E27 1x 60W

IP44

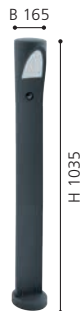

L 120



9 002759 960124



96011 PROPENDA

floor luminaire; cast aluminium, anthracite / plastic, white
Stehleuchte; Aluguss, anthrazit / Kunststoff, weiss
lampadaire; fonte d'aluminium, anthracite / plastique, blanc

L 120, B 165, H 1035, Base: B 165, T 135



E27 1x 60W

IP44

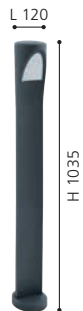

L 120



9 002759 960117



90°, 6 m
10 sec. - 5 min.

**SAFETY &
COMFORT**

96009 PROPENDA

wall luminaire; cast aluminium, anthracite / plastic, white
Wandleuchte; Aluguss, anthrazit / Kunststoff, weiss
applique; fonte d'aluminium, anthracite / plastique, blanc

L 120, H 260, A 175



E27

1x 60W

IP44



9 002759 960094



96008 PROPENDA

wall luminaire; cast aluminium, anthracite / plastic, white
Wandleuchte; Aluguss, anthrazit / Kunststoff, weiss
applique; fonte d'aluminium, anthracite / plastique, blanc

L 120, H 260, A 175



E27

1x 60W

IP44



9 002759 960087





LED

95076 ABRANTES

wall luminaire; cast aluminium, anthracite / glass, clear
Wandleuchte; Aluguss, anthrazit / Glas, klar
applique; fonte d'aluminium, anthracite / verre, clair

L 120, H 200, A 130

LED

2x 6W

warm
WHITE

1300lm



IP44



9 002759 950767

A+



96012



LED



120°, 6 m
10 sec. - 8 min.

**SAFETY &
COMFORT**

97312 BELCREDA

wall luminaire; cast aluminium, anthracite / plastic, white
Wandleuchte; Aluguss, anthrazit / Kunststoff, weiss
applique; fonte d'aluminium, anthracite / plastique, blanc

L 330, H 125, A 165



9,3W 1200lm



IP44



9 002759 973124



A++



LED



120°, 6 m
10 sec. - 8 min.

**SAFETY &
COMFORT**

97311 BELCREDA

wall luminaire; cast aluminium, white / plastic, white
Wandleuchte; Aluguss, weiss / Kunststoff, weiss
applique; fonte d'aluminium, blanc / plastique, blanc

L 330, H 125, A 165



9,3W 1200lm



IP44



9 002759 973117



A++

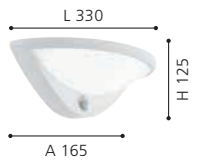

97312



96274 EMOLLIO

wall luminaire; cast aluminium, white / plastic, white
 Wandleuchte; Aluguss, weiss / Kunststoff, weiss
 applique; fonte d'aluminium, blanc / plastique, blanc

L 200, H 160, A 80



10W 1000lm

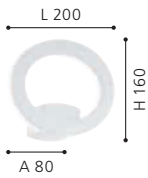

96275 EMOLLIO

wall luminaire; cast aluminium, anthracite / plastic, white
 Wandleuchte; Aluguss, anthrazit / Kunststoff, weiss
 applique; fonte d'aluminium, anthracite / plastique, blanc

L 200, H 160, A 80



10W 1000lm





97241 CALPINO

wall luminaire; cast aluminium, white
Wandleuchte; Aluguss, weiss
applique; fonte d'aluminium, blanc

L 105, H 105, A 110

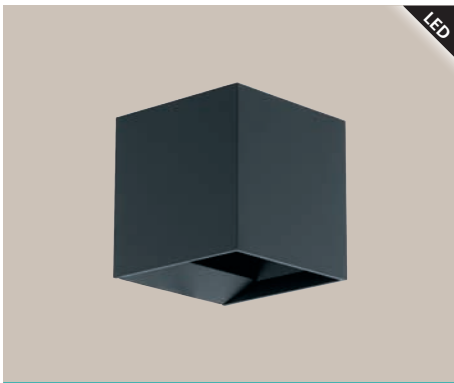
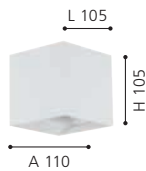

97242 CALPINO

wall luminaire; cast aluminium, anthracite
Wandleuchte; Aluguss, anthrazit
applique; fonte d'aluminium, anthracite

L 105, H 105, A 110

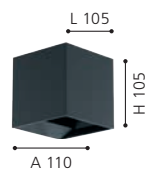



95097 DESELLA 1

wall luminaire; cast aluminium, anthracite / plastic, white
Wandleuchte; Aluguss, anthrazit / Kunststoff, weiss
applique; fonte d'aluminium, anthracite / plastique, blanc

L 160, H 160, A 190

LED

10W

warm
WHITE

900lm



IP54



9 002759 950972

A+

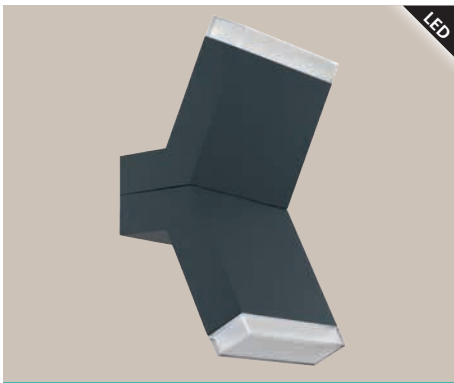
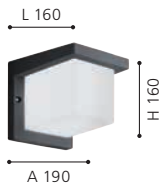

97154 CANTZO

wall luminaire; zinc-plated steel, anthracite / plastic, white
Wandleuchte; Stahl verzinkt, anthrazit / Kunststoff, weiss
applique; acier galvanisé, anthracite / plastique, blanc

L 115, H 225, A 105

LED

2x 4W

warm
WHITE

2x
550lm



IP44



9 002759 971540

A++

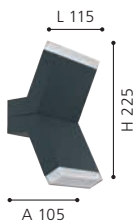

97154



96281 ROALES

wall luminaire; cast aluminium, silver / plastic, white
 Wandleuchte; Aluguss, silber / Kunststoff, weiss
 applique; fonte d'aluminium, argent / plastique, blanc

L 140, H 60, A 170



1x 3,2W 210lm

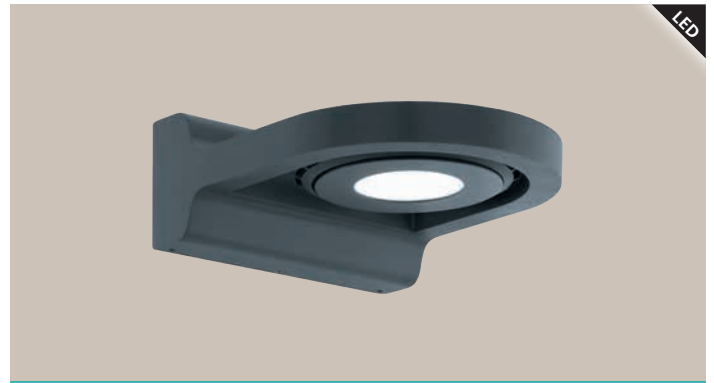
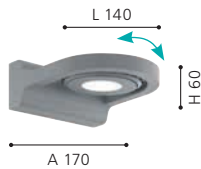

96282 ROALES

wall luminaire; cast aluminium, anthracite / plastic, white
 Wandleuchte; Aluguss, anthrazit / Kunststoff, weiss
 applique; fonte d'aluminium, anthracite / plastique, blanc

L 140, H 60, A 170



1x 3,2W 210lm

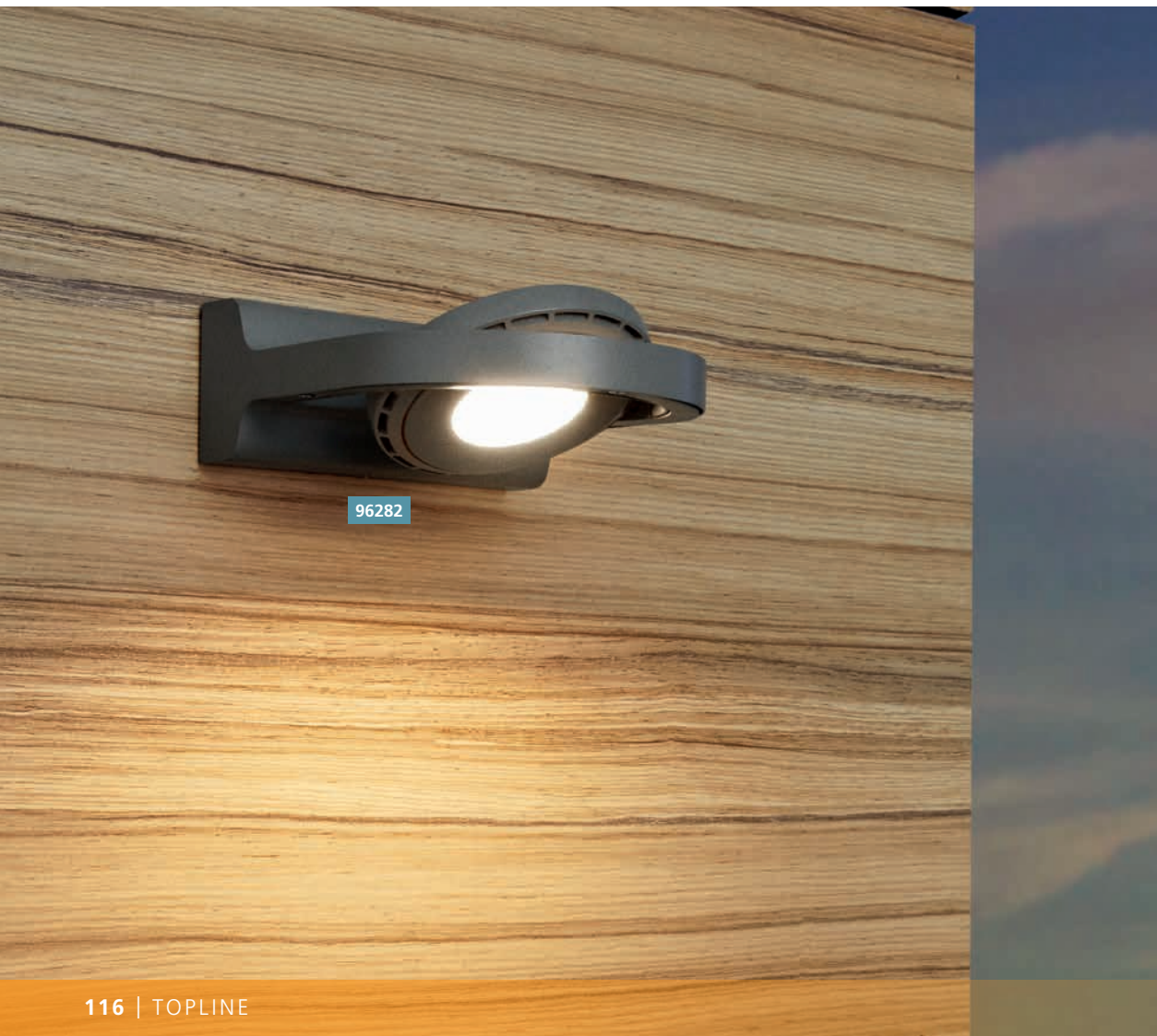
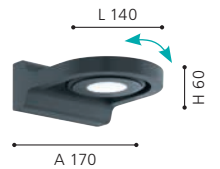

96282



ROALES

With this luminaire you can choose different lighting scenes.

Bei dieser Leuchte können sie nach Belieben unterschiedliche Lichtszenen wählen.

Vous pouvez sélectionner au choix avec ces luminaires trois différentes ambiances lumineuses.



96488

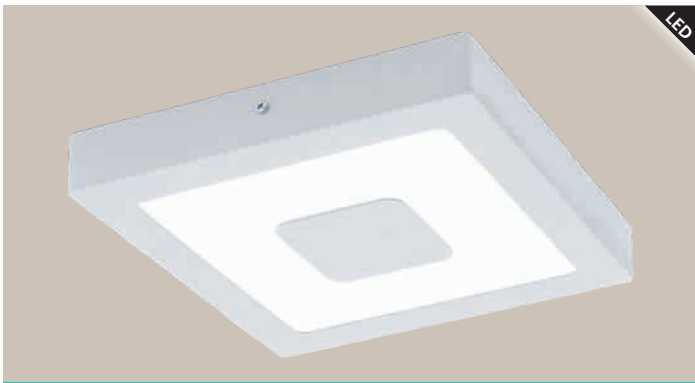

LED

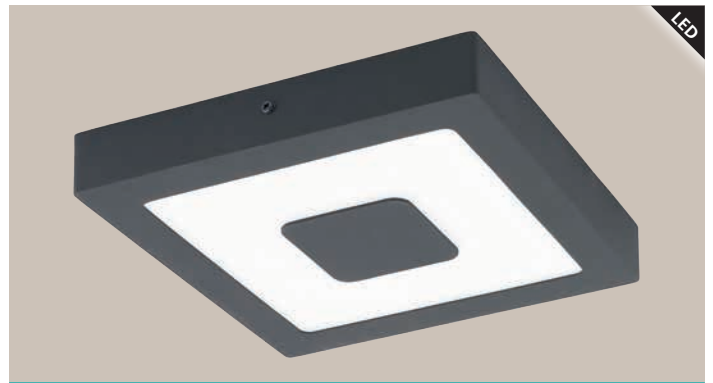

LED

96488 IPHIAS

wall / ceiling luminaire; cast aluminium, white / plastic, white
Wand- / Deckenleuchte; Aluguss, weiss / Kunststoff, weiss
applique / plafonnier; fonte d'aluminium, blanc / plastique, blanc

L 225, B 225, H 40



16,5W 1700lm

IP44



9 002759 964887

A+

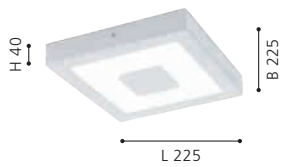

96489 IPHIAS

wall / ceiling luminaire; cast aluminium, anthracite / plastic, white
Wand- / Deckenleuchte; Aluguss, anthrazit / Kunststoff, weiss
applique / plafonnier; fonte d'aluminium, anthracite / plastique, blanc

L 225, B 225, H 40



16,5W 1700lm

IP44



9 002759 964894

A+

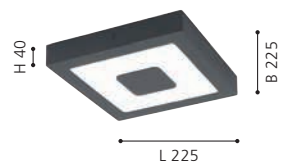



94799 BEVERLY 1

wall luminaire; stainless steel, stainless steel / plastic, white, clear
 Wandleuchte; Edelstahl, edelstahl / Kunststoff, weiss, klar
 applique; acier inoxydable, acier inoxydable / plastique, blanc, clair

L 200, H 270, A 130

LED
 2x 3,7W
 warm WHITE
 2x
 280lm
 IP44



9 002759 947996



95079 BRIONES

wall luminaire; cast aluminium, stainless steel / plastic, white
 Wandleuchte; Aluguss, edelstahl / Kunststoff, weiss
 applique; fonte d'aluminium, acier inoxydable / plastique, blanc

L 85, H 95, A 125

LED
 2x 3W
 warm WHITE
 500lm
 IP44



9 002759 950798

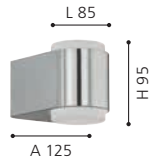

94799



120°, 6 m
 10 sec. - 8 min.

SAFETY & COMFORT

97297 CHEIRA

wall luminaire; cast aluminium, silver / plastic, white
 Wandleuchte; Aluguss, silber / Kunststoff, weiss
 applique; fonte d'aluminium, argent / plastique, blanc

L 295, H 300, A 60

LED
 2x 2,7W
 warm WHITE
 2x
 300lm
 LED
 1x 3,6W
 warm WHITE
 1x
 430lm
 IP44



9 002759 972974





97297

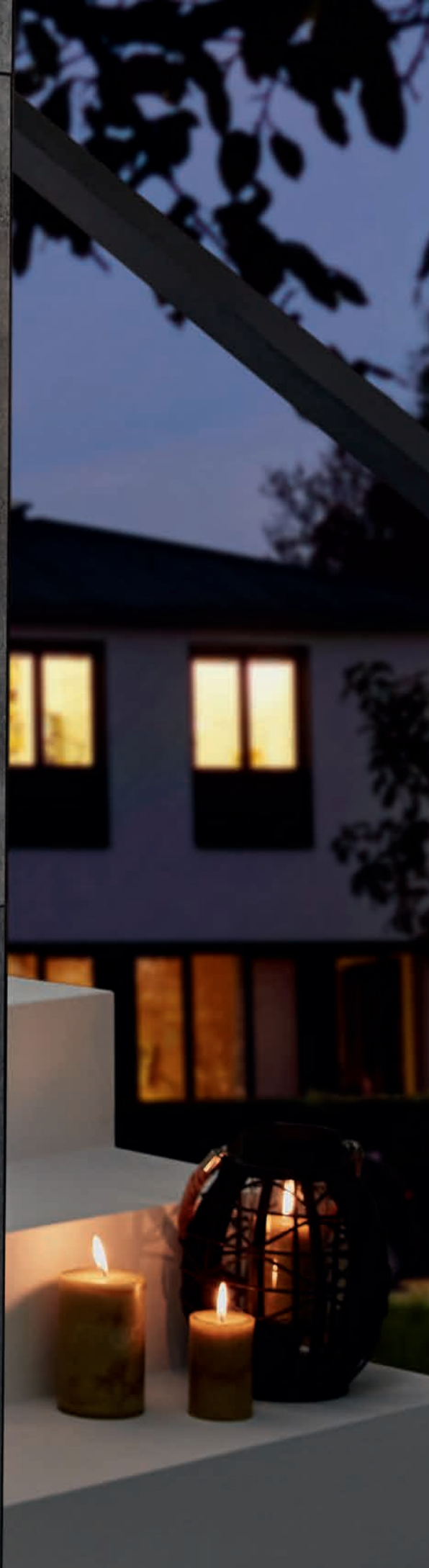

CLASSIC

KLASSIK
CLASSIQUE

TIMELESS CLASSICS - Romantic and nostalgic elements from different materials create unique luminaires for your outdoor area. True classics for a real wellness ambience.

ZEITLOSE KLASSIKER - Romantische und nostalgische Elemente aus unterschiedlichen Materialien kreieren einzigartige Leuchten für Ihren Außenbereich. Wahre Klassiker für echtes Wohlfühlambiente.



CLASSIQUE INTEMPOREL - Des éléments romantiques et nostalgiques issus de différents matériaux forment d' uniques luminaires pour votre extérieur. De véritables classiques pour une vraie ambiance de bien-être.



OVERVIEW

CLASSIC





VILLAGRAZIA
124



ALAMONTE
125



SONCINO
125



PARETTA
125



ALAMONTE 1
126



SIRMIONE
128



PAULLO
130



VERLUCCA
131



HILBURN
132



BARROSELA
135



HILBURN 1
135



ALBACETE
135



PULFERO
137



PULFERO 1
137



MELGOA
138



BARROSELA
138



AIROLA
139



ENTRIMO
139



SOSPIRO
139



CANOVE
140



TRECCATE
140



VALDEO
141



BOVOLONE
141



COLINDRES
142



BARROSELA
142



AIROLA
143



MELGOA
143



MILTON
144



SAN TELMO
144



VALDEO
144



ALBACETE
144



MONTEVECCHIO-HD
146



MONREALE
146



MONREALE
148



COMUNERO 2
150



ALORIA
153



ALORIA
155



LISIO
156



MILTON
157



MOUNA
157



SIDNEY
158



SOSSANO
160



MONSELICE
160



MANERBIO
160



SOSSANO
161



MONSELICE
161



MANERBIO
161



LATERNA 4
163



LATERNA 5
165



NAVEDO
166



NAVEDO
170

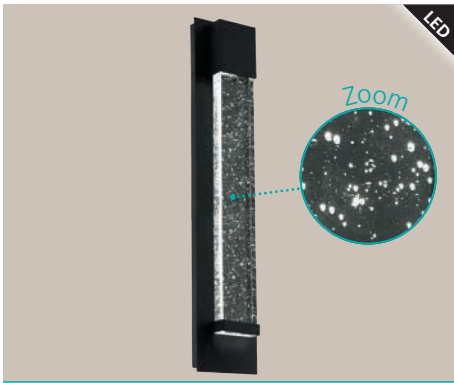

98154 VILLAGRAZIA

wall luminaire; aluminium, black / glass with air inclusions, clear
 Wandleuchte; Alu, schwarz / Glas mit Lufteinschlüssen, klar
 applique; aluminium, noir / verre avec inclusions d'air, clair

L 120, H 400, A 70

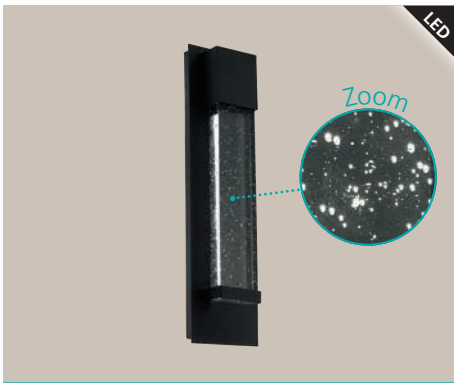
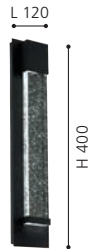

98153 VILLAGRAZIA

wall luminaire; aluminium, black / glass with air inclusions, clear
 Wandleuchte; Alu, schwarz / Glas mit Lufteinschlüssen, klar
 applique; aluminium, noir / verre avec inclusions d'air, clair

L 120, H 300, A 70





97477 PARETTA

wall luminaire; stainless steel, stainless steel / glass, clear
 Wandleuchte; Edelstahl, edelstahl / Glas, klar
 applique; acier inoxydable, acier inoxydable / verre, clair

L 170, H 275, A 100



97478 PARETTA

wall luminaire; zinc-plated steel, black / glass, clear
 Wandleuchte; Stahl verzinkt, schwarz / Glas, klar
 applique; acier galvanisé, noir / verre, clair

L 170, H 275, A 100



94827 ALAMONTE

wall luminaire; stainless steel, stainless steel / glass, clear
 Wandleuchte; Edelstahl, edelstahl / Glas, klar
 applique; acier inoxydable, acier inoxydable / verre, clair

L 170, H 260, A 100



97294 SONCINO

wall luminaire; cast aluminium, black / glass, clear
 Wandleuchte; Aluguss, schwarz / Glas, klar
 applique; fonte d'aluminium, noir / verre, clair

L 265, H 330, A 120





94833 ALAMONTE 1

floor luminaire; zinc-plated steel, black / glass, clear
 Stehleuchte; Stahl verzinkt, schwarz / Glas, klar
 lampadaire; acier galvanisé, noir / verre, clair

L 150, B 150, H 1015, Base: Ø 110



94831 ALAMONTE 1

wall luminaire; zinc-plated steel, black / glass, clear
 Wandleuchte; Stahl verzinkt, schwarz / Glas, klar
 applique; acier galvanisé, noir / verre, clair

L 170, H 260, A 100



98273 ALAMONTE 1

wall luminaire; zinc-plated steel, black / glass, clear
 Wandleuchte; Stahl verzinkt, schwarz / Glas, klar
 applique; acier galvanisé, noir / verre, clair

L 150, H 380, A 100



94789 ALAMONTE 1

table luminaire; zinc-plated steel, black / glass, clear
 Tischleuchte; Stahl verzinkt, schwarz / Glas, klar
 luminaire de table; acier galvanisé, noir / verre, clair

L 150, B 150, H 275

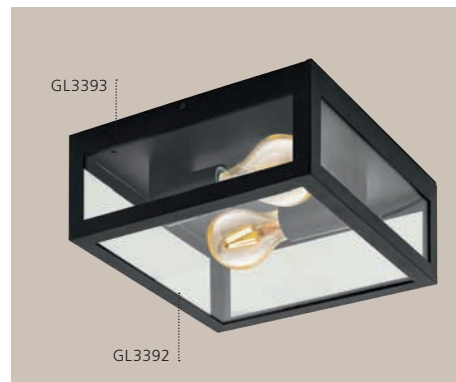

94832 ALAMONTE 1

wall / ceiling luminaire; zinc-plated steel, black / glass, clear
 Wand- / Deckenleuchte; Stahl verzinkt, schwarz / Glas, klar
 applique / plafonnier; acier galvanisé, noir / verre, clair

L 290, H 290, A 130





94788 ALAMONTE 1

pendant luminaire; zinc-plated steel, black / glass, clear
 Hängeleuchte; Stahl verzinkt, schwarz / Glas, klar
 luminaire en suspension; acier galvanisé, noir / verre, clair

L 150, B 150, H 1285



94831

94789



97287 SIRMIONE

floor luminaire; zinc-plated steel, black, gold / glass opal-matt, white

Stehleuchte; Stahl verzinkt, schwarz, gold / Glas opal-matt, weiss
lampadaire; acier galvanisé, noir, or / verre opale mat, blanc

L 340, B 270, H 1200, Base: Ø 110

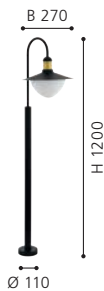

9 002759 972875

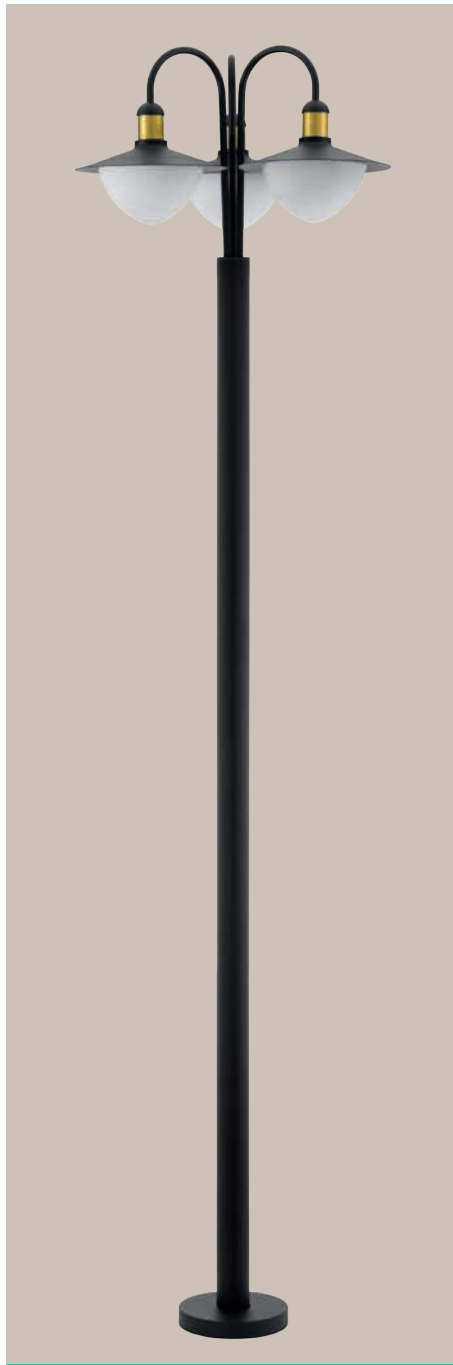

97288 SIRMIONE

floor luminaire; zinc-plated steel, black, gold / glass opal-matt, white

Stehleuchte; Stahl verzinkt, schwarz, gold / Glas opal-matt, weiss
lampadaire; acier galvanisé, noir, or / verre opale mat, blanc

H 2200, Ø 550, Base: Ø 200



9 002759 972882



97285 SIRMIONE

wall luminaire; zinc-plated steel, black, gold / glass opal-matt, white

Wandleuchte; Stahl verzinkt, schwarz, gold / Glas opal-matt, weiss
applique; acier galvanisé, noir, or / verre opale mat, blanc

L 270, H 375, A 330



9 002759 972851



97286 SIRMIONE

wall luminaire; zinc-plated steel, black, gold / glass opal-matt, white

Wandleuchte; Stahl verzinkt, schwarz, gold / Glas opal-matt, weiss
applique; acier galvanisé, noir, or / verre opale mat, blanc

L 270, H 375, A 330



9 002759 972868



SAFETY & COMFORT



100°, 8 m
10 sec. - 15 min.



97285

97287



97229 PAULLO

floor luminaire; zinc-plated steel, black / glass, white
 Stehleuchte; Stahl verzinkt, schwarz / Glas, weiss
 lampadaire; acier galvanisé, noir / verre, blanc

H 765, Ø 135, Base: Ø 100



97227 PAULLO

wall luminaire; zinc-plated steel, black / glass, white
 Wandleuchte; Stahl verzinkt, schwarz / Glas, weiss
 applique; acier galvanisé, noir / verre, blanc

L 135, H 345, A 160



97228 PAULLO

pedestal luminaire; zinc-plated steel, black / glass, white
 Sockelleuchte; Stahl verzinkt, schwarz / Glas, weiss
 luminaire pour socle; acier galvanisé, noir / verre, blanc

H 360, Ø 135, Base: Ø 100



97228



97245 VERLUCCA

floor luminaire; zinc-plated steel, black / glass, clear, black
 Stehleuchte; Stahl verzinkt, schwarz / Glas, klar, schwarz
 lampadaire; acier galvanisé, noir / verre, clair, noir

H 990, Ø 210, Base: Ø 140



97244 VERLUCCA

wall luminaire; zinc-plated steel, black / glass, clear, black
 Wandleuchte; Stahl verzinkt, schwarz / Glas, klar, schwarz
 applique; acier galvanisé, noir / verre, clair, noir

L 210, H 265, A 245



97445 VERLUCCA

wall luminaire; zinc-plated steel, black / glass, clear, black
 Wandleuchte; Stahl verzinkt, schwarz / Glas, klar, schwarz
 applique; acier galvanisé, noir / verre, clair, noir

L 210, H 335, A 220



SAFETY &
COMFORT



97244



94844 HILBURN

floor luminaire; zinc-plated steel, black / plastic, transparent
 Stehleuchte; Stahl verzinkt, schwarz / Kunststoff, transparent
 lampadaire; acier galvanisé, noir / plastique, transparent

L 200, B 135, H 1030, Base: Ø 150



E27 1x 60W IP44



9 002759 948443



94842 HILBURN

wall luminaire; zinc-plated steel, black / plastic, transparent
 Wandleuchte; Stahl verzinkt, schwarz / Kunststoff, transparent
 applique; acier galvanisé, noir / plastique, transparent

L 200, H 375, A 170



E27 1x 60W IP44



9 002759 948429



94843 HILBURN

wall luminaire; zinc-plated steel, black / plastic, transparent
 Wandleuchte; Stahl verzinkt, schwarz / Kunststoff, transparent
 applique; acier galvanisé, noir / plastique, transparent

L 200, H 280, A 200

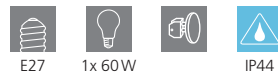

E27 1x 60W IP44



9 002759 948436



94864 HILBURN

pedestal luminaire; zinc-plated steel, black / plastic, transparent
 Sockelleuchte; Stahl verzinkt, schwarz / Kunststoff, transparent
 luminaire pour socle; acier galvanisé, noir / plastique, transparent

L 200, B 135, H 410, Base: Ø 110



E27 1x 60W IP44



9 002759 948641





94844



94868 HILBURN 1

floor luminaire; zinc-plated steel, silver-antique / plastic, transparent

Stehleuchte; Stahl verzinkt, silber-antik / Kunststoff, transparent

lampadaire; acier galvanisé, argent antique / plastique, transparent

L 200, B 135, H 1030, Base: Ø 150



E27



1x 60W



IP44



9 002759 948689



A++-E

L 200



H 1030



94865 HILBURN 1

wall luminaire; zinc-plated steel, silver-antique / plastic, transparent

Wandleuchte; Stahl verzinkt, silber-antik / Kunststoff, transparent

applique; acier galvanisé, argent antique / plastique, transparent

L 200, H 375, A 170

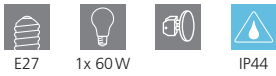

94866 HILBURN 1

wall luminaire; zinc-plated steel, silver-antique / plastic, transparent

Wandleuchte; Stahl verzinkt, silber-antik / Kunststoff, transparent

applique; acier galvanisé, argent antique / plastique, transparent

L 200, H 280, A 200

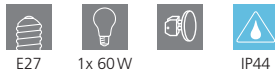

94867 HILBURN 1

pedestal luminaire; zinc-plated steel, silver-antique / plastic, transparent

Sockelleuchte; Stahl verzinkt, silber-antik / Kunststoff, transparent

luminaire pour socle; acier galvanisé, argent antique / plastique, transparent

L 200, B 135, H 410, Base: Ø 110

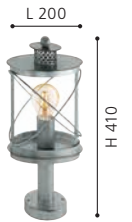

94859 BARROSELA

wall luminaire; zinc-plated steel, silver-antique / plastic, white

Wandleuchte; Stahl verzinkt, silber-antik / Kunststoff, weiss

applique; acier galvanisé, argent antique / plastique, blanc

L 220, H 240, A 230



96263 ALBACETE

wall luminaire; zinc-plated steel, silver-antique / glass with air inclusions, clear

Wandleuchte; Stahl verzinkt, silber-antik / Glas mit Lufteinschlüssen, klar

applique; acier galvanisé, argent antique / verre avec inclusions d'air, clair

L 265, H 255, A 280





94834

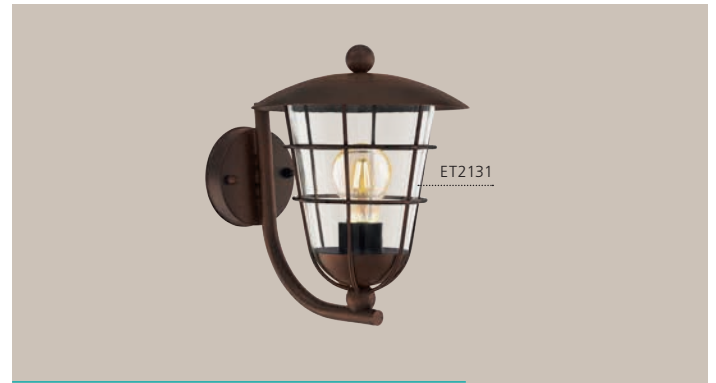

94855 PULFERO 1

wall luminaire; zinc-plated steel, brown / plastic, transparent
 Wandleuchte; Stahl verzinkt, braun / Kunststoff, transparent
 applique; acier galvanisé, marron / plastique, transparent

L 220, H 280, A 280



94854 PULFERO 1

wall luminaire; zinc-plated steel, brown / plastic, transparent
 Wandleuchte; Stahl verzinkt, braun / Kunststoff, transparent
 applique; acier galvanisé, marron / plastique, transparent

L 220, H 280, A 280

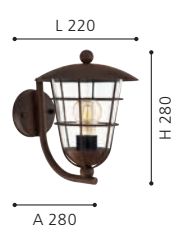

94841 PULFERO

wall luminaire; zinc-plated steel, black / plastic, transparent
 Wandleuchte; Stahl verzinkt, schwarz / Kunststoff, transparent
 applique; acier galvanisé, noir / plastique, transparent

L 220, H 280, A 280



94834 PULFERO

wall luminaire; zinc-plated steel, black / plastic, transparent
 Wandleuchte; Stahl verzinkt, schwarz / Kunststoff, transparent
 applique; acier galvanisé, noir / plastique, transparent

L 220, H 280, A 280





94792



94805 BARROSELA

wall luminaire; zinc-plated steel, black / plastic, white
Wandleuchte; Stahl verzinkt, schwarz / Kunststoff, weiss
applique; acier galvanisé, noir / plastique, blanc

L 220, H 240, A 230



94792 MELGOA

wall luminaire; zinc-plated steel, black / glass, clear
Wandleuchte; Stahl verzinkt, schwarz / Glas, klar
applique; acier galvanisé, noir / verre, clair

L 300, H 250, A 380





33143 AIROLA

wall luminaire; zinc-plated steel, black / plastic, white
Wandleuchte; Stahl verzinkt, schwarz / Kunststoff, weiss
applique; acier galvanisé, noir / plastique, blanc

L 220, H 220, A 230



96207 ENTRIMO

wall luminaire; zinc-plated steel, black / plastic, white
Wandleuchte; Stahl verzinkt, schwarz / Kunststoff, weiss

applique; acier galvanisé, noir / plastique, blanc

L 200, H 185, A 235



97246 SOSPIRO

wall luminaire; zinc-plated steel, black / glass opal-matt, white
Wandleuchte; Stahl verzinkt, schwarz / Glas opal-matt, weiss

applique; acier galvanisé, noir / verre opale mat, blanc

L 270, H 295, A 320



97246



97226 CANOVE

wall luminaire; zinc-plated steel, black / glass, clear, satiné
Wandleuchte; Stahl verzinkt, schwarz / Glas, klar, satiniert
applique; acier galvanisé, noir / verre, clair, satiné

L 230, H 240, A 235



97296 TRECATE

wall luminaire; zinc-plated steel, black / glass, clear
Wandleuchte; Stahl verzinkt, schwarz / Glas, klar
applique; acier galvanisé, noir / verre, clair

L 160, H 355, A 130





97261 BOVOLONE

wall luminaire; zinc-plated steel, black / glass, clear
Wandleuchte; Stahl verzinkt, schwarz / Glas, klar
applique; acier galvanisé, noir / verre, clair

L 110, H 340, A 155



97261



96239 VALDEO

wall luminaire; zinc-plated steel, black / glass, clear
Wandleuchte; Stahl verzinkt, schwarz / Glas, klar
applique; acier galvanisé, noir / verre, clair

L 165, H 275, A 200

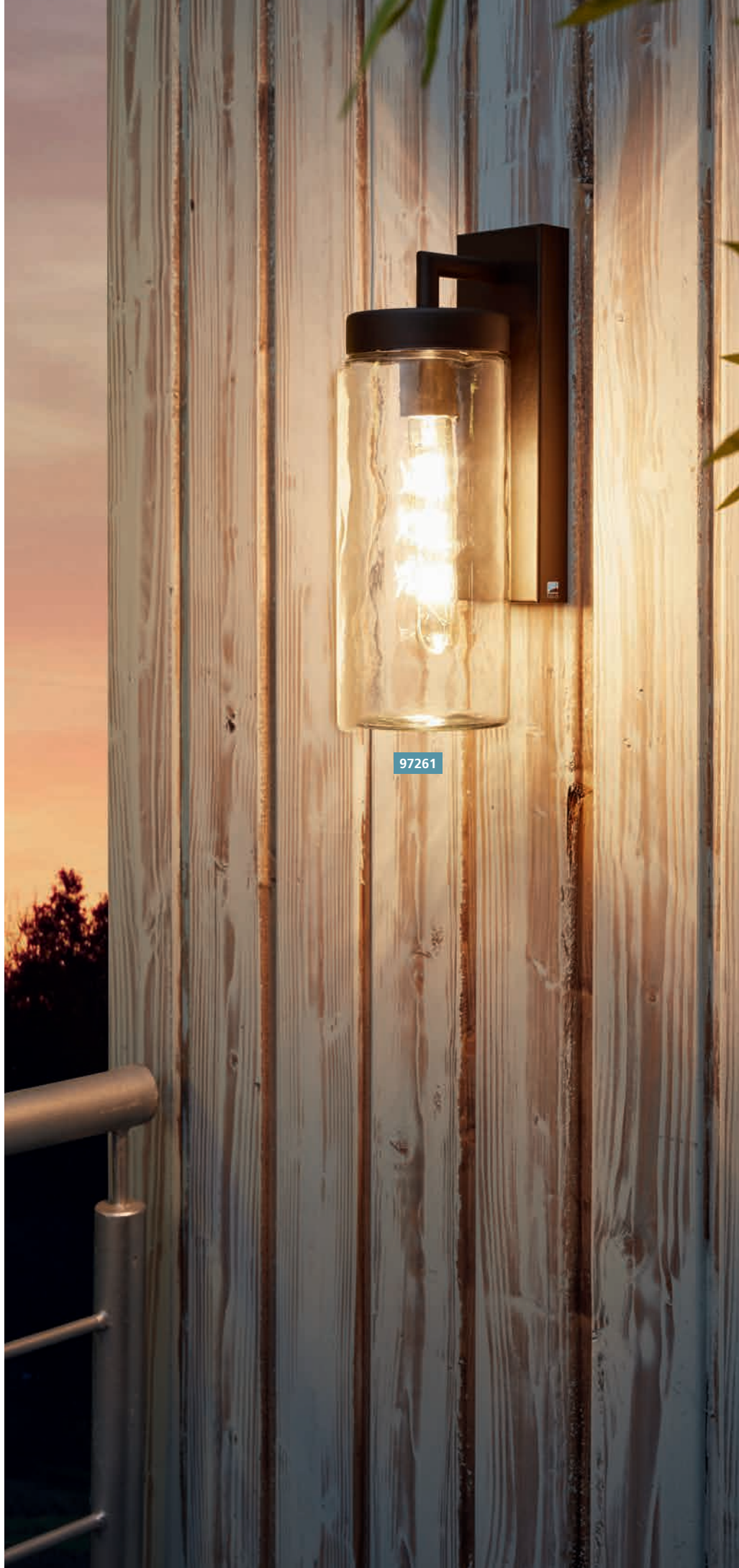



ET2130

94837 COLINDRES

pendant luminaire; zinc-plated steel, copper-coloured antique / plastic, white

Hängeleuchte; Stahl verzinkt, kupferfarben-antik / Kunststoff, weiss

luminaire en suspension; acier galvanisé, cuivré antique / plastique, blanc

H 1270, Ø 215



E27 1x 60W IP44



9 002759 948375

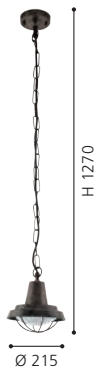

ET2130

94838 COLINDRES

wall luminaire; zinc-plated steel, copper-coloured antique / plastic, white

Wandleuchte; Stahl verzinkt, kupferfarben-antik / Kunststoff, weiss

applique; acier galvanisé, cuivré antique / plastique, blanc

L 215, H 290, A 275



E27 1x 60W IP44



9 002759 948382



ET2397

94858 BARROSELA

wall luminaire; zinc-plated steel, copper-coloured antique / plastic, white

Wandleuchte; Stahl verzinkt, kupferfarben-antik / Kunststoff, weiss

applique; acier galvanisé, cuivré antique / plastique, blanc

L 220, H 240, A 230



E27 1x 40W IP44



9 002759 948580



94838



33144



94863 MELGOA

wall luminaire; zinc-plated steel, copper-coloured antique / glass, clear
 Wandleuchte; Stahl verzinkt, kupferfarben-antik / Glas, klar
 applique; acier galvanisé, cuivré antique / verre, clair

L 300, H 250, A 380



33144 AIROLA

wall luminaire; zinc-plated steel, copper-coloured antique / plastic, white
 Wandleuchte; Stahl verzinkt, kupferfarben-antik / Kunststoff, weiss
 applique; acier galvanisé, cuivré antique / plastique, blanc

L 220, H 220, A 230





90184 SAN TELMO

wall luminaire; zinc-plated steel, cast aluminium, antique-brown / glass with air inclusions, clear
 Wandleuchte; Stahl verzinkt, Aluguss, antik-braun / Glas mit Luft einschüssen, klar
 applique; acier galvanisé, fonte d'aluminium, marron antique / verre avec inclusions d'air, clair

L 180, H 350, A 240



96241 VALDEO

wall luminaire; zinc-plated steel, copper-coloured antique / glass, clear
 Wandleuchte; Stahl verzinkt, kupferfarben-antik / Glas, klar
 applique; acier galvanisé, cuivré antique / verre, clair

L 165, H 275, A 200



96262 ALBACETE

wall luminaire; zinc-plated steel, brown, copper / glass with air inclusions, clear
 Wandleuchte; Stahl verzinkt, braun, kupfer / Glas mit Luft einschüssen, klar
 applique; acier galvanisé, marron, cuivre / verre avec inclusions d'air, clair

L 265, H 255, A 280



83589 MILTON

wall luminaire; zinc-plated steel, antique-brown / glass, clear
 Wandleuchte; Stahl verzinkt, antik-braun / Glas, klar
 applique; acier galvanisé, marron antique / verre, clair

B 240, H 310, A 300

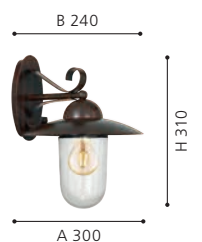
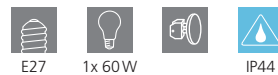



83589



98123 MONREALE

floor luminaire; cast aluminium, black / plastic, transparent
 Stehleuchte; Aluguss, schwarz / Kunststoff, transparent
 lampadaire; fonte d'aluminium, noir / plastique, transparent

H 995, Ø 230, Base: Ø 110



98121 MONREALE

wall luminaire; cast aluminium, black / plastic, transparent
 Wandleuchte; Aluguss, schwarz / Kunststoff, transparent
 applique; fonte d'aluminium, noir / plastique, transparent

L 230, H 275, A 255



98119 MONREALE

wall luminaire; cast aluminium, black / plastic, transparent
 Wandleuchte; Aluguss, schwarz / Kunststoff, transparent
 applique; fonte d'aluminium, noir / plastique, transparent

L 230, H 275, A 255



98122 MONREALE

pedestal luminaire; cast aluminium, black / plastic, transparent
 Sockelleuchte; Aluguss, schwarz / Kunststoff, transparent
 luminaire pour socle; fonte d'aluminium, noir / plastique, transparent

H 335, Ø 230, Base: Ø 110



98029 MONTEVECCHIO-HD

wall luminaire; plastic, steel, black / plastic, transparent
 Wandleuchte; Kunststoff, Stahl, schwarz / Kunststoff, transparent
 applique; plastique, acier, noir / plastique, transparent

L 220, H 330, A 250

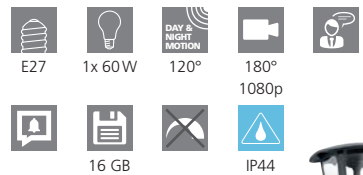

HD
SAFETY & COMFORT



98121



98118 MONREALE

floor luminaire; cast aluminium, white / plastic, transparent
 Stehleuchte; Aluguss, weiss / Kunststoff, transparent
 lampadaire; fonte d'aluminium, blanc / plastique, transparent

H 995, Ø 230, Base: Ø 110

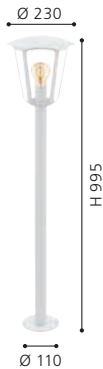

98116 MONREALE

wall luminaire; cast aluminium, white / plastic, transparent
 Wandleuchte; Aluguss, weiss / Kunststoff, transparent
 applique; fonte d'aluminium, blanc / plastique, transparent

L 230, H 275, A 255



98115 MONREALE

wall luminaire; cast aluminium, white / plastic, transparent
 Wandleuchte; Aluguss, weiss / Kunststoff, transparent
 applique; fonte d'aluminium, blanc / plastique, transparent

L 230, H 275, A 255



98117 MONREALE

pedestal luminaire; cast aluminium, white / plastic, transparent
 Sockelleuchte; Aluguss, weiss / Kunststoff, transparent
 luminaire pour socle; fonte d'aluminium, blanc / plastique, transparent

H 335, Ø 230, Base: Ø 110



98118

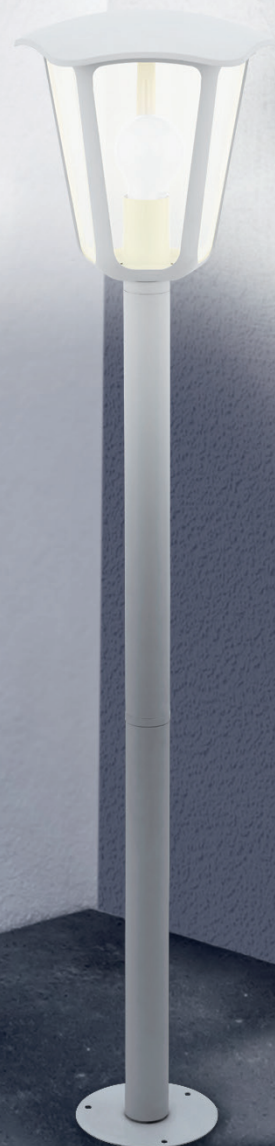



97338 COMUNERO 2

floor luminaire; cast aluminium, black / plastic, transparent
 Stehleuchte; Aluguss, schwarz / Kunststoff, transparent
 lampadaire; fonte d'aluminium, noir / plastique, transparent

H 1000, Ø 175, Base: Ø 110

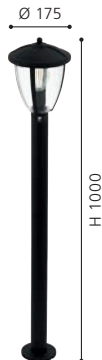
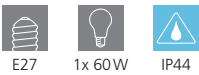

97335 COMUNERO 2

wall luminaire; cast aluminium, black / plastic, transparent
 Wandleuchte; Aluguss, schwarz / Kunststoff, transparent
 applique; fonte d'aluminium, noir / plastique, transparent

L 175, H 275, A 225



97336 COMUNERO 2

wall luminaire; cast aluminium, black / plastic, transparent
 Wandleuchte; Aluguss, schwarz / Kunststoff, transparent
 applique; fonte d'aluminium, noir / plastique, transparent

L 175, H 275, A 225



97337 COMUNERO 2

pedestal luminaire; cast aluminium, black / plastic, transparent
 Sockelleuchte; Aluguss, schwarz / Kunststoff, transparent
 luminaire pour socle; fonte d'aluminium, noir / plastique, transparent

H 300, Ø 175, Base: Ø 110





97336



97337





93406 ALORIA

pendant luminaire; cast aluminium, black / plastic, clear
 Hängeleuchte; Aluguss, schwarz / Kunststoff, klar
 luminaire en suspension; fonte d'aluminium, noir / plastique, clair

L 170, B 170, H 685

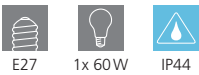

93409 ALORIA

floor luminaire; cast aluminium, black / plastic, clear
 Stehleuchte; Aluguss, schwarz / Kunststoff, klar
 lampadaire; fonte d'aluminium, noir / plastique, clair

H 1800, Ø 480, Base: Ø 215



93408 ALORIA

floor luminaire; cast aluminium, black / plastic, clear
 Stehleuchte; Aluguss, schwarz / Kunststoff, klar
 lampadaire; fonte d'aluminium, noir / plastique, clair

L 170, B 170, H 940, Base: Ø 170





93097 ALORIA

wall luminaire; cast aluminium, black / plastic, clear
Wandleuchte; Aluguss, schwarz / Kunststoff, klar
applique; fonte d'aluminium, noir / plastique, clair

L 170, H 225, A 190



93098 ALORIA

wall luminaire; cast aluminium, black / plastic, clear
Wandleuchte; Aluguss, schwarz / Kunststoff, klar
applique; fonte d'aluminium, noir / plastique, clair

L 170, H 225, A 190



93407 ALORIA

wall luminaire; cast aluminium, black / plastic, clear
Wandleuchte; Aluguss, schwarz / Kunststoff, klar
applique; fonte d'aluminium, noir / plastique, clair

L 180, H 200, A 120



93099 ALORIA

pedestal luminaire; cast aluminium, black / plastic, clear
Sockelleuchte; Aluguss, schwarz / Kunststoff, klar
luminaire pour socle; fonte d'aluminium, noir / plastique, clair

L 170, B 170, H 300, Base: Ø 170



93098



93402 ALORIA

pendant luminaire; cast aluminium, white / plastic, clear
 Hängeleuchte; Aluguss, weiss / Kunststoff, klar
 luminaire en suspension; fonte d'aluminium, blanc / plastique, clair

L 170, B 170, H 685



E27 1x 60W IP44



9 002759 934026

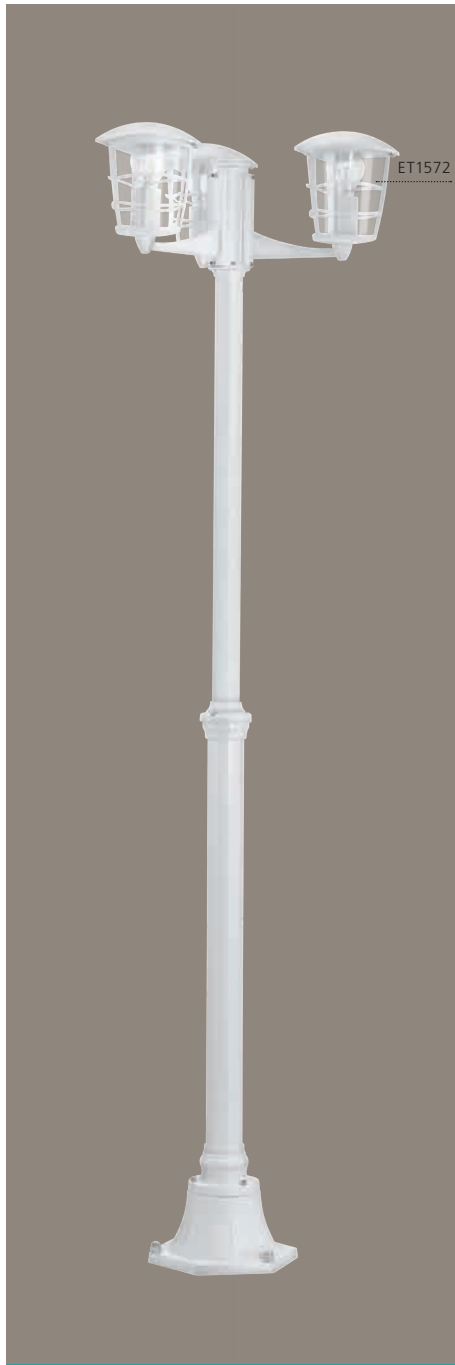

93405 ALORIA

floor luminaire; cast aluminium, white / plastic, clear
 Stehleuchte; Aluguss, weiss / Kunststoff, klar
 lampadaire; fonte d'aluminium, blanc / plastique, clair

H 1800, Ø 480, Base: Ø 215



E27 3x 60W IP44



9 002759 934057



93404 ALORIA

floor luminaire; cast aluminium, white / plastic, clear
 Stehleuchte; Aluguss, weiss / Kunststoff, klar
 lampadaire; fonte d'aluminium, blanc / plastique, clair

L 170, B 170, H 940, Base: Ø 170



E27 1x 60W IP44



9 002759 934040

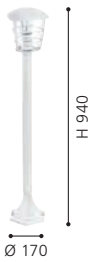



93094 ALORIA

wall luminaire; cast aluminium, white / plastic, clear
Wandleuchte; Aluguss, weiss / Kunststoff, klar
applique; fonte d'aluminium, blanc / plastique, clair

L 170, H 225, A 190



93095 ALORIA

wall luminaire; cast aluminium, white / plastic, clear
Wandleuchte; Aluguss, weiss / Kunststoff, klar
applique; fonte d'aluminium, blanc / plastique, clair

L 170, H 225, A 190



93403 ALORIA

wall luminaire; cast aluminium, white / plastic, clear
Wandleuchte; Aluguss, weiss / Kunststoff, klar
applique; fonte d'aluminium, blanc / plastique, clair

L 180, H 200, A 120



93096 ALORIA

pedestal luminaire; cast aluminium, white / plastic, clear
Sockelleuchte; Aluguss, weiss / Kunststoff, klar
luminaire pour socle; fonte d'aluminium, blanc / plastique, clair

L 170, B 170, H 300, Base: Ø 170



93403



30186 LISIO

pendant luminaire; stainless steel, stainless steel / glass, clear
 Hängeleuchte; Edelstahl, edelstahl / Glas, klar
 luminaire en suspension; acier inoxydable, acier inoxydable / verre, clair

H 880, Ø 175

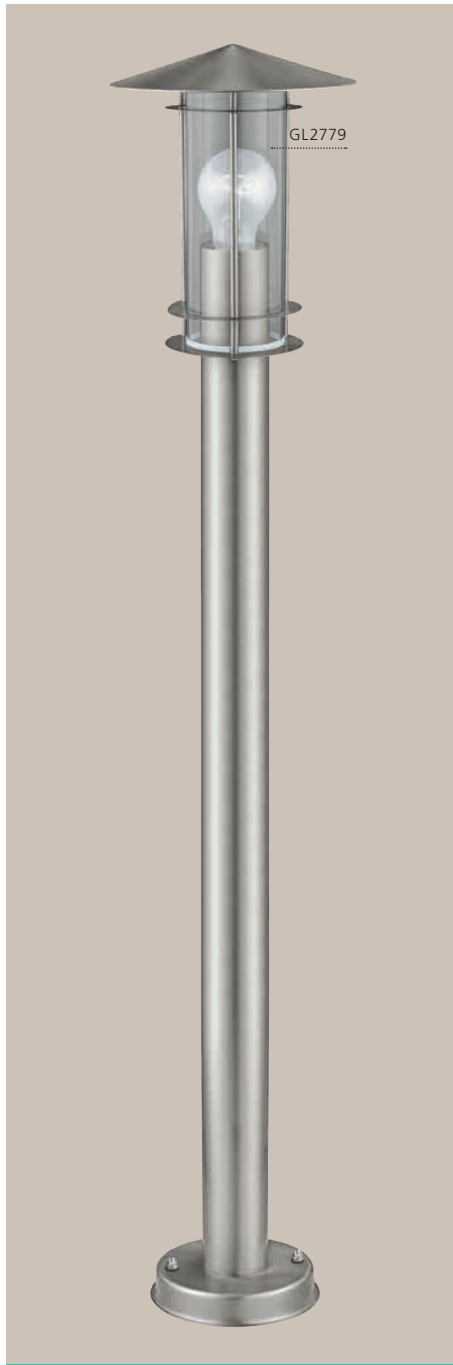

30188 LISIO

floor luminaire; stainless steel, stainless steel / glass, clear
 Stehleuchte; Edelstahl, edelstahl / Glas, klar
 lampadaire; acier inoxydable, acier inoxydable / verre, clair

H 1000, Ø 175, Base: Ø 130

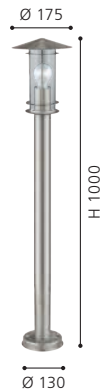

30184 LISIO

wall luminaire; stainless steel, stainless steel / glass, clear
 Wandleuchte; Edelstahl, edelstahl / Glas, klar
 applique; acier inoxydable, acier inoxydable / verre, clair

L 175, H 300, A 225



30187 LISIO

floor luminaire; stainless steel, stainless steel / glass, clear
 Stehleuchte; Edelstahl, edelstahl / Glas, klar
 lampadaire; acier inoxydable, acier inoxydable / verre, clair

H 500, Ø 175, Base: Ø 130

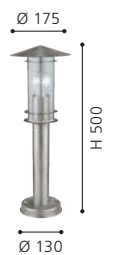

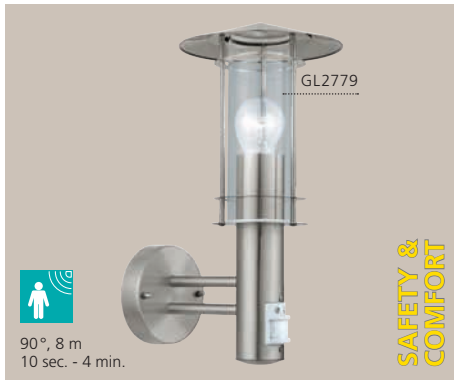

30185 LISIO

wall luminaire; stainless steel, stainless steel / glass, clear
Wandleuchte; Edelstahl, edelstahl / Glas, klar
applique; acier inoxydable, acier inoxydable / verre, clair

L 175, H 360, A 225

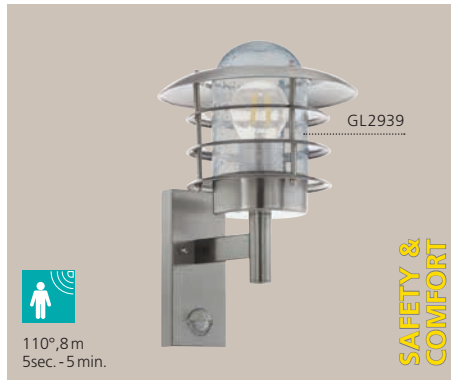
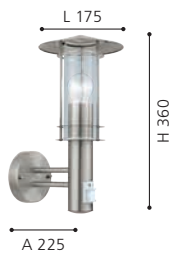
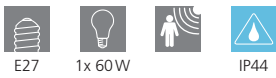

96402 MOUNA

wall luminaire; stainless steel, stainless steel / glass, clear
Wandleuchte; Edelstahl, edelstahl / Glas, klar
applique; acier inoxydable, acier inoxydable / verre, clair

H 265, Ø 220, A 240

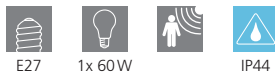

83588 MILTON

wall luminaire; stainless steel, stainless steel / glass, clear
Wandleuchte; Edelstahl, edelstahl / Glas, klar
applique; acier inoxydable, acier inoxydable / verre, clair

B 240, H 310, A 300

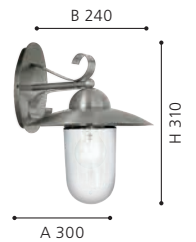
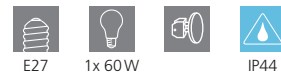

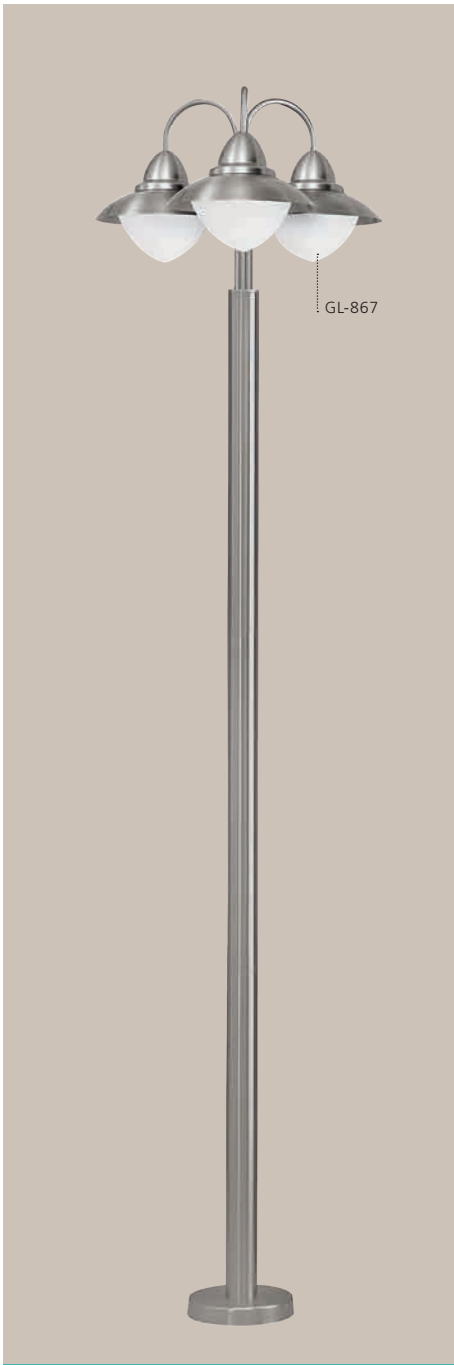

83971 SIDNEY

floor luminaire; stainless steel, stainless steel / glass opal-matt, white

Stehleuchte; Edelstahl, edelstahl / Glas opal-matt, weiss
 lampadaire; acier inoxydable, acier inoxydable / verre opale mat, blanc

H 2200, Ø 600, Base: Ø 200

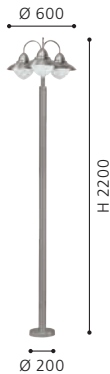

83969 SIDNEY

floor luminaire; stainless steel, stainless steel / glass opal-matt, white

Stehleuchte; Edelstahl, edelstahl / Glas opal-matt, weiss
 lampadaire; acier inoxydable, acier inoxydable / verre opale mat, blanc

B 350, H 1200, Base: Ø 120

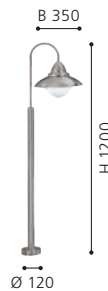

83966 SIDNEY

wall luminaire; stainless steel, stainless steel / glass opal-matt, white

Wandleuchte; Edelstahl, edelstahl / Glas opal-matt, weiss
 applique; acier inoxydable, acier inoxydable / verre opale mat, blanc

H 375, Ø 270, A 325



87105 SIDNEY

wall luminaire; stainless steel, stainless steel / glass opal-matt, white

Wandleuchte; Edelstahl, edelstahl / Glas opal-matt, weiss
 applique; acier inoxydable, acier inoxydable / verre opale mat, blanc

H 375, Ø 275, A 325





83969



97259



180°, 6 m
10 sec. - 15 min.

**SAFETY &
COMFORT**

97153 SOSSANO

wall luminaire; plastic, black / glass with air inclusions, clear
Wandleuchte; Kunststoff, schwarz / Glas mit Lufteinschlüssen, klar
applique; plastique, noir / verre avec inclusions d'air, clair

L 200, H 335, A 210



E27



1x 28W



IP44



L 200



H 335

A 210



9 002759 971533



110°, 7 m
5 sec. - 5 min.

**SAFETY &
COMFORT**

97259 MANERBIO

wall luminaire; cast aluminium, black / glass, clear
Wandleuchte; Aluguss, schwarz / Glas, klar
applique; fonte d'aluminium, noir / verre, clair

L 240, H 295, A 125



E27



1x 60W



IP44



L 240



H 295

A 125



9 002759 972592



180°, 6 m
10 sec. - 15 min.

**SAFETY &
COMFORT**

97257 MONSELICE

wall luminaire; plastic, black / glass, black, clear
Wandleuchte; Kunststoff, schwarz / Glas, schwarz, klar
applique; plastique, noir / verre, noir, clair

L 195, H 430, A 205



E27



1x 28W



IP44



L 195



H 430

A 205



9 002759 972578





180°, 6 m
10 sec. - 15 min.

**SAFETY &
COMFORT**

97155 SOSSANO

wall luminaire; plastic, white / glass with air inclusions, clear
Wandleuchte; Kunststoff, weiss / Glas mit Lufteinschlüssen, klar
applique; plastique, blanc / verre avec inclusions d'air, clair

L 200, H 335, A 210



110°, 7 m
5 sec. - 5 min.

**SAFETY &
COMFORT**

97258 MANERBIO

wall luminaire; cast aluminium, white / glass, clear
Wandleuchte; Aluguss, weiss / Glas, klar
applique; fonte d'aluminium, blanc / verre, clair

L 240, H 295, A 125

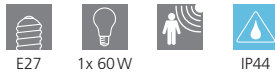

180°, 6 m
10 sec. - 15 min.

**SAFETY &
COMFORT**

97256 MONSELICE

wall luminaire; plastic, white / glass, white, clear
Wandleuchte; Kunststoff, weiss / Glas, weiss, klar
applique; plastique, blanc / verre, blanc, clair

L 195, H 430, A 205

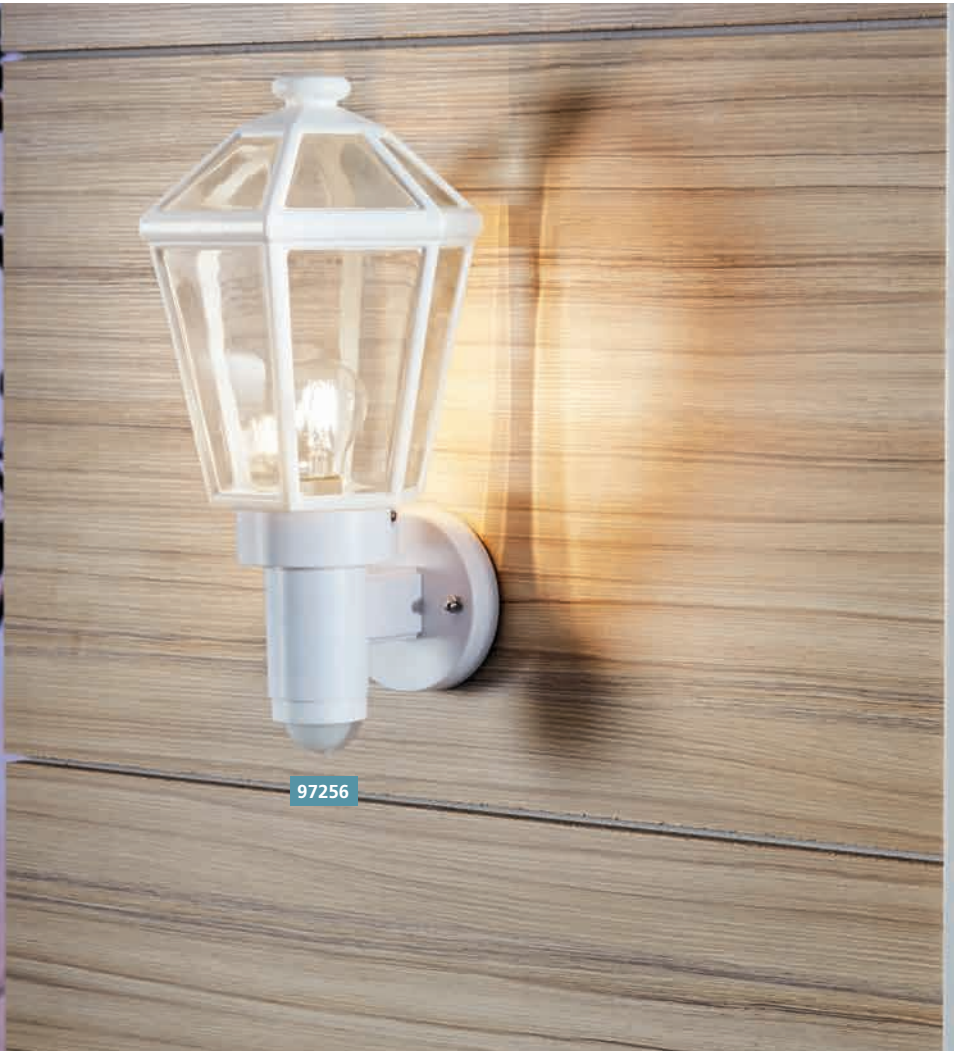

97256



22471 LATERNA 4

pendant luminaire; cast aluminium, black / glass, clear
 Hängeleuchte; Aluguss, schwarz / Glas, klar
 luminaire en suspension; fonte d'aluminium, noir / verre, clair

H 900, Ø 205

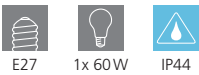

22145 LATERNA 4

floor luminaire; cast aluminium, black / glass, clear
 Stehleuchte; Aluguss, schwarz / Glas, klar
 lampadaire; fonte d'aluminium, noir / verre, clair

H 1920, Ø 550, Base: Ø 260



22144 LATERNA 4

floor luminaire; cast aluminium, black / glass, clear
 Stehleuchte; Aluguss, schwarz / Glas, klar
 lampadaire; fonte d'aluminium, noir / verre, clair

H 1000, Ø 205, Base: Ø 170

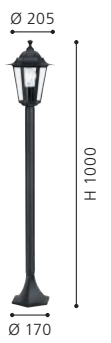



22467 LATERNA 4

wall luminaire; cast aluminium, black / glass, clear
Wandleuchte; Aluguss, schwarz / Glas, klar
applique; fonte d'aluminium, noir / verre, clair

L 165, H 350, A 210



22468 LATERNA 4

wall luminaire; cast aluminium, black / glass, clear
Wandleuchte; Aluguss, schwarz / Glas, klar
applique; fonte d'aluminium, noir / verre, clair

L 165, H 320, A 230



22469 LATERNA 4

wall luminaire; cast aluminium, black / glass, clear
Wandleuchte; Aluguss, schwarz / Glas, klar
applique; fonte d'aluminium, noir / verre, clair

L 165, H 360, A 215

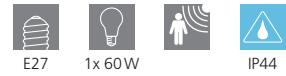

SAFETY & COMFORT

120°, 8 m
5 sec. - 9 min.



22472 LATERNA 4

pedestal luminaire; cast aluminium, black / glass, clear
Sockelleuchte; Aluguss, schwarz / Glas, klar
luminaire pour socle; fonte d'aluminium, noir / verre, clair

H 385, Ø 195, Base: Ø 170

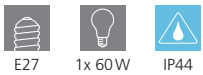

22468

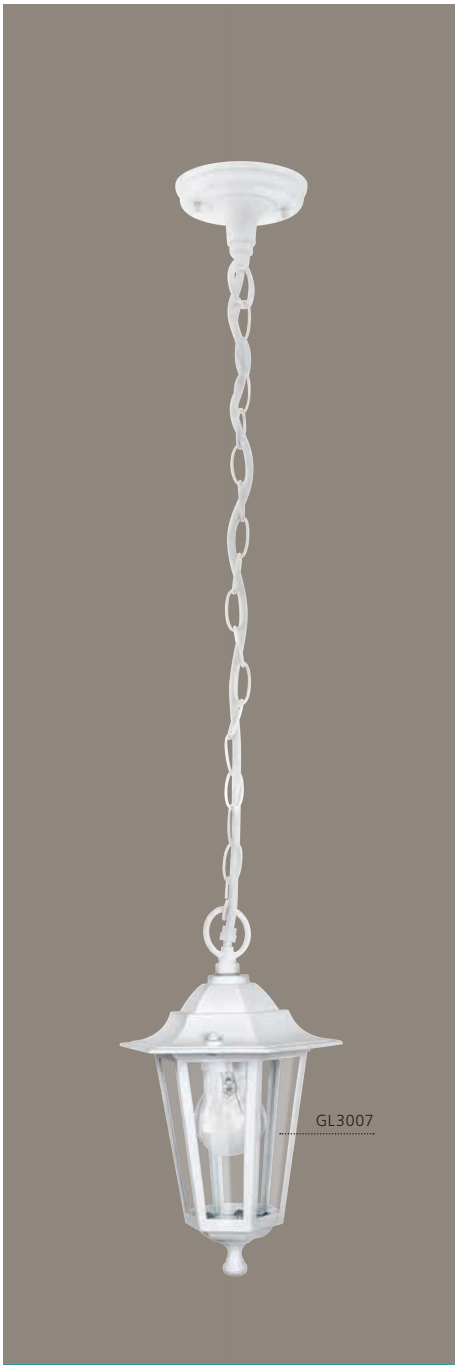

22465 LATERNA 5

pendant luminaire; cast aluminium, white / glass, clear
 Hängeleuchte; Aluguss, weiss / Glas, klar
 luminaire en suspension; fonte d'aluminium, blanc / verre, clair

H 900, Ø 205



22996 LATERNA 5

floor luminaire; cast aluminium, white / glass, clear
 Stehleuchte; Aluguss, weiss / Glas, klar
 lampadaire; fonte d'aluminium, blanc / verre, clair

H 1920, Ø 535, Base: Ø 260

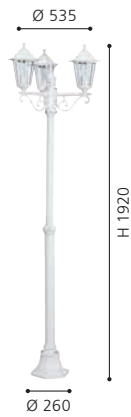

22995 LATERNA 5

floor luminaire; cast aluminium, white / glass, clear
 Stehleuchte; Aluguss, weiss / Glas, klar
 lampadaire; fonte d'aluminium, blanc / verre, clair

H 1030, Ø 195, Base: Ø 170

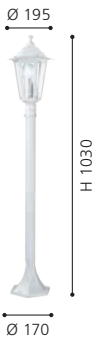



GL3007

22462 LATERNA 5

wall luminaire; cast aluminium, white / glass, clear
Wandleuchte; Aluguss, weiss / Glas, klar
applique; fonte d'aluminium, blanc / verre, clair

L 165, H 350, A 210



GL3007

22463 LATERNA 5

wall luminaire; cast aluminium, white / glass, clear
Wandleuchte; Aluguss, weiss / Glas, klar
applique; fonte d'aluminium, blanc / verre, clair

L 165, H 320, A 230



GL3007



120°, 8 m
5 sec. - 9 min.

SAFETY & COMFORT

22464 LATERNA 5

wall luminaire; cast aluminium, white / glass, clear
Wandleuchte; Aluguss, weiss / Glas, klar
applique; fonte d'aluminium, blanc / verre, clair

L 165, H 360, A 215

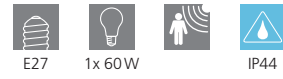

GL3007

22466 LATERNA 5

pedestal luminaire; cast aluminium, white / glass, clear
Sockelleuchte; Aluguss, weiss / Glas, klar
luminaire pour socle; fonte d'aluminium, blanc / verre, clair

H 385, Ø 195, Base: Ø 170



22465



GL3005

93456 NAVEDO

wall luminaire; cast aluminium, black, silver-patina / glass, clear
Wandleuchte; Aluguss, schwarz, silber-patina / Glas, klar
applique; fonte d'aluminium, noir, argent patiné / verre, clair

L 200, H 475, A 285



GL3005

93457 NAVEDO

wall luminaire; cast aluminium, black, silver-patina / glass, clear
Wandleuchte; Aluguss, schwarz, silber-patina / Glas, klar
applique; fonte d'aluminium, noir, argent patiné / verre, clair

L 200, H 475, A 285



GL3005



110°, 7 m
5 sec. - 5 min.

SAFETY &
COMFORT

93458 NAVEDO

wall luminaire; cast aluminium, black, silver-patina / glass, clear
Wandleuchte; Aluguss, schwarz, silber-patina / Glas, klar
applique; fonte d'aluminium, noir, argent patiné / verre, clair

L 200, H 425, A 285



GL3006

93459 NAVEDO

wall luminaire; cast aluminium, black, silver-patina / glass, clear
Wandleuchte; Aluguss, schwarz, silber-patina / Glas, klar
applique; fonte d'aluminium, noir, argent patiné / verre, clair

L 290, H 430, A 130



GL3005

93462 NAVEDO

pedestal luminaire; cast aluminium, black, silver-patina / glass, clear
Sockelleuchte; Aluguss, schwarz, silber-patina / Glas, klar
luminaire pour socle; fonte d'aluminium, noir, argent patiné / verre, clair

H 470, Ø 230, Base: Ø 170



GL3005

93455 NAVEDO

pendant luminaire; cast aluminium, black, silver-patina / glass, clear
Hängeleuchte; Aluguss, schwarz, silber-patina / Glas, klar
luminaire en suspension; fonte d'aluminium, noir, argent patiné / verre, clair

H 1045, Ø 230





93457





93465 NAVEDO

floor luminaire; cast aluminium, black, silver-patina / glass, clear
 Stehleuchte; Aluguss, schwarz, silber-patina / Glas, klar
 lampadaire; fonte d'aluminium, noir, argent patiné / verre, clair

H 2200, Ø 560, Base: Ø 230

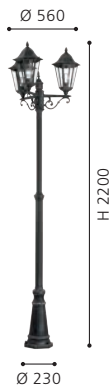

93464 NAVEDO

floor luminaire; cast aluminium, black, silver-patina / glass, clear
 Stehleuchte; Aluguss, schwarz, silber-patina / Glas, klar
 lampadaire; fonte d'aluminium, noir, argent patiné / verre, clair

H 2000, Ø 230, Base: Ø 245



93463 NAVEDO

floor luminaire; cast aluminium, black, silver-patina / glass, clear
 Stehleuchte; Aluguss, schwarz, silber-patina / Glas, klar
 lampadaire; fonte d'aluminium, noir, argent patiné / verre, clair

H 1200, Ø 230, Base: Ø 170





93454 NAVEDO

floor luminaire; cast aluminium, white / glass, clear
 Stehleuchte; Aluguss, weiss / Glas, klar
 lampadaire; fonte d'aluminium, blanc / verre, clair

H 2200, Ø 560, Base: Ø 230

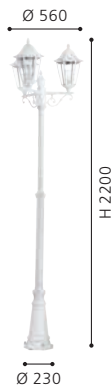

93453 NAVEDO

floor luminaire; cast aluminium, white / glass, clear
 Stehleuchte; Aluguss, weiss / Glas, klar
 lampadaire; fonte d'aluminium, blanc / verre, clair

H 2000, Ø 230, Base: Ø 245

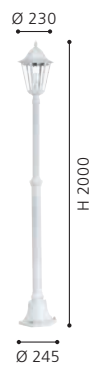

93452 NAVEDO

floor luminaire; cast aluminium, white / glass, clear
 Stehleuchte; Aluguss, weiss / Glas, klar
 lampadaire; fonte d'aluminium, blanc / verre, clair

H 1200, Ø 230, Base: Ø 170





93445 NAVEDO

wall luminaire; cast aluminium, white / glass, clear
Wandleuchte; Aluguss, weiss / Glas, klar
applique; fonte d'aluminium, blanc / verre, clair

L 200, H 475, A 285



93446 NAVEDO

wall luminaire; cast aluminium, white / glass, clear
Wandleuchte; Aluguss, weiss / Glas, klar
applique; fonte d'aluminium, blanc / verre, clair

L 200, H 475, A 285



93447 NAVEDO

wall luminaire; cast aluminium, white / glass, clear
Wandleuchte; Aluguss, weiss / Glas, klar
applique; fonte d'aluminium, blanc / verre, clair

L 200, H 425, A 285

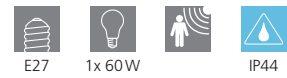

SAFETY & COMFORT

110°, 7 m
5 sec. - 5 min.



93448 NAVEDO

wall luminaire; cast aluminium, white / glass, clear
Wandleuchte; Aluguss, weiss / Glas, klar
applique; fonte d'aluminium, blanc / verre, clair

L 290, H 430, A 130



93451 NAVEDO

pedestal luminaire; cast aluminium, white / glass, clear
Sockelleuchte; Aluguss, weiss / Glas, klar
luminaire pour socle; fonte d'aluminium, blanc / verre, clair

H 470, Ø 230, Base: Ø 170



93444 NAVEDO

pendant luminaire; cast aluminium, white / glass, clear
Hängeleuchte; Aluguss, weiss / Glas, klar
luminaire en suspension; fonte d'aluminium, blanc / verre, clair

H 1045, Ø 230





93445

SPOTS, RECESSED & ACCESSOIRES

SPOTS, EINBAULEUCHTEN & ZUBEHÖR

SPOTS, LUMINAIRES ENCASTRÉS & ACCESSOIRES

HIGHLIGHTS FOR

OUTDOORS - Any outdoor area can be skilfully presented with spots, fitted lamps and the associated accessories. Stairwells, paths or the favourite spot in your garden will become a highlight this way.

HIGHLIGHTS FÜR DRAUSSEN - Mit Spots, Einbauleuchten und den dazugehörigen Accessoires lässt sich jeder Außenbereich gekonnt in Szene setzen. Treppenaufgänge, Wege oder der Lieblingsplatz im Garten werden so zum Highlight.



POINTS FORTS POUR

L'EXTÉRIEUR - Des spots, les luminaires encastrables et les accessoires associés mettent en scène avec savoir tout espace extérieur. Les accès à des escaliers, les chemins ou bien votre emplacement préféré deviennent ainsi le centre des attentions.



OVERVIEW

SPOTS, RECESSED & ACCESSOIRES





PAGINO
176



PAGINO
176



CASABAS
176



PALIZZI
178



CASABAS
178



PASTION
178



LUNANO
180



LM_LED_E27
181



DETECT ME 5
181



DETECT ME 6
182



DETECT ME 3
182



DETECT ME 4
182



DETECT ME 1
183



NEMA 1
184



NEMA 1
184



NEMA
184



FAEDO 4
184



PIERA 2
185



SPINETOLI
185



FAEDO 4
185



FAEDO 3
186



FAEDO 3
188



FAEDO 3
190



FAEDO 3
191



LAMEDO
192



LAMEDO
192



RIGA 3
193



TRONTO
192



MARGO
194



PINEDA-IP
194



PINEDA-IP
194



ZIMBA
196



ZIMBA
196



ZIMBA-LED
196



ZIMBA-LED
196



CONNECTOR BOX
198



CONNECTOR BOX
198



PARK 4
198



PARK T
198



200



CUBA
200



98175 PAGINOPAGINO

wall luminaire; plastic, white
Wandleuchte; Kunststoff, weiss
applique; plastique, blanc

L 245, H 220, A 180

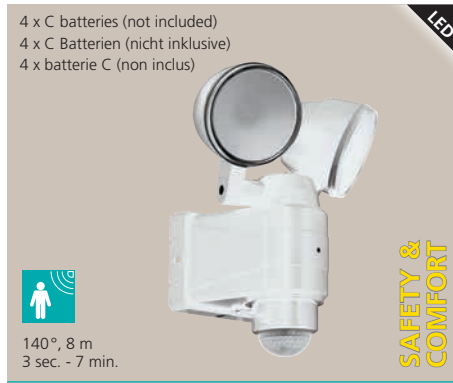
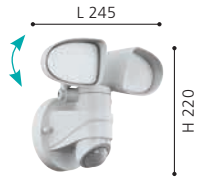

98194 CASABAS

wall luminaire; plastic, white / plastic, satiné
Wandleuchte; Kunststoff, weiss / Kunststoff, satiniert
applique; plastique, blanc / plastique, satiné

L 190, H 240, A 120

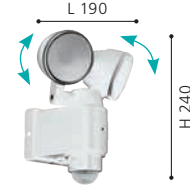

98177 PAGINOPAGINO

wall luminaire; plastic, white
Wandleuchte; Kunststoff, weiss
applique; plastique, blanc

L 180, H 260, A 160

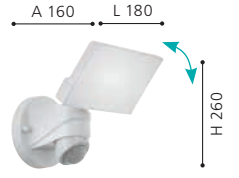

98176 PAGINOPAGINO

wall luminaire; plastic, black
Wandleuchte; Kunststoff, schwarz
applique; plastique, noir

L 245, H 220, A 180



98189 CASABAS

wall luminaire; plastic, black / plastic, satiné
Wandleuchte; Kunststoff, schwarz / Kunststoff, satiniert
applique; plastique, noir / plastique, satiné

L 190, H 240, A 120



98178 PAGINOPAGINO

wall luminaire; plastic, black
Wandleuchte; Kunststoff, schwarz
applique; plastique, noir

L 180, H 260, A 160





98178



98195 CASABAS

wall luminaire; plastic, black / plastic, white
Wandleuchte; Kunststoff, schwarz / Kunststoff, weiss
applique; plastique, noir / plastique, blanc

L 115, H 155, A 130

LED 5,4W cold WHITE 230lm
ACCU Li-ion 1800mAh
IP44
A+++ - A



98196 CASABAS

wall luminaire; plastic, white / plastic, white
Wandleuchte; Kunststoff, weiss / Kunststoff, weiss
applique; plastique, blanc / plastique, blanc

L 115, H 155, A 130

LED 5,4W cold WHITE 230lm
ACCU Li-ion 1800mAh
IP44
A+++ - A



98187 PALIZZI

wall luminaire; plastic, black / plastic, transparent
Wandleuchte; Kunststoff, schwarz / Kunststoff, transparent
applique; plastique, noir / plastique, transparent

L 155, H 145, A 110

LED 2W warm WHITE 150lm
ACCU AA, Ni-Mh 600mAh
IP44
A+++ - A



98196



98191 PASTION

wall luminaire; plastic, black

L 180, H 120, A 130

LED 4,5W warm WHITE 200lm
ACCU Li-ion 2200mAh
IP44
A+++ - A



98191



97339 LUNANO

wall luminaire; plastic, silver / plastic, white
 Wandleuchte; Kunststoff, silber / Kunststoff, weiss
 applique; plastique, argent / plastique, blanc

L 200, H 215, A 75

LED
 2W
warm WHITE
ACCU
 Li-ion 2000mAh

IP44



97339

Security and Comfort without electricity

This luminaire has a solar panel (full capacity with 6h sun).
 No difficult cabling necessary, battery operated.
 2 operation modes:
ECO mode: 3lm / 40h bright life
Standard mode: 20lm / 8h bright life

Sicherheit und Komfort ohne Strom

Diese Leuchte hat ein Solarpanel (volle Kapazität nach 6 Sonnenstunden). Keine aufwändige Verkabelung notwendig, da batteriebetrieben.
 2 Einstellungsmodi:
ECO mode: 3lm / 40h Leuchtdauer
Standard mode: 20lm / 8h Leuchtdauer

Sécurité et confort sans électricité

Ce luminaire dispose d'un panneau solaire (pleine capacité avec 6h de soleil). Pas de câblage difficile nécessaire, à la batterie.
 2 operation modes:
ECO mode: 3lm / 40h vie lumineuse
Standard mode: 20lm / 8h vie lumineuse



1x A-F 3x 0-9

97339

Letters and numbers included in delivery.

Buchstaben und Zahlen im Lieferumfang enthalten.

Les lettres et les nombres sont inclus dans la livraison.





SAFETY & COMFORT

97418 DETECT ME 5

motion detector; plastic, white
Bewegungsmelder; Kunststoff, weiss
détecteur de mouvement; plastique, blanc

L 65, H 95, A 35



IP44



9 002759 974183



A 35



806 lm

5 year warranty
5 ans de garantie
5 años de garantía

SAFETY & COMFORT

11714 E27-LED-A60

illuminant
Leuchtmittel
ampoule

L 115, Ø 60



E27

1x 9,5W

3000K

25000h



220-240V, 15000x
50/60Hz

15000x

>80

10



9 002759 117146



A+



9,5W

60W



11714

Security and Comfort for little money

This bulb has a Day & Night sensor and switches on automatically at dusk or off at dawn. Thanks to the E27 socket the bulb can easily be exchanged for existing luminaires. With an average electricity price of € 0,16 / KWh and an average lighting time of 8 hours / day, the costs amount to approx. € 5,00 per year.

Sicherheit und Komfort für wenig Geld

Dieses Leuchtmittel verfügt über einen Day & Night Sensor und schaltet sich selbständig bei Dunkelheit ein bzw. bei Helligkeit aus. Dank der E27 Fassung kann das Leuchtmittel einfach in bestehende Leuchten getauscht werden. Bei einem durchschnittlichen Strompreis von € 0,16 / KWh und einer durchschnittlichen Leuchtdauer von 8 Stunden / Tag belaufen sich die Kosten auf ca. € 5,00 pro Jahr.

Sécurité et confort pour peu d'argent

Cette ampoule possède un capteur Day & Night et s'allume automatiquement au crépuscule ou à l'aube. Grâce à la prise E27, l'ampoule peut être facilement échangée contre les luminaires extérieurs. Avec un prix moyen de l'électricité de € 0,16 / KWh et un temps d'éclairage moyen de 8 heures / jour, les coûts s'élèvent à env. € 5,00 par an.



SAFETY & COMFORT

97419 DETECT ME 5

motion detector; plastic, black
Bewegungsmelder; Kunststoff, schwarz
détecteur de mouvement; plastique, noir

L 65, H 95, A 35



IP44



9 002759 974190



A 35



DETECT ME 5

Automatic illumination. This Photo-electric lighting controller is used for controlling lighting systems for building fronts and automatically switches light 'ON' at dusk automatically 'OFF' again at dawn. Of course, the light-level threshold at which the sensor responds and turns the light 'ON' is defined by no other than you yourself.

Automatische Beleuchtung. Der Day & Night Sensor dient zur Steuerung von Beleuchtungsanlagen an Hausfronten und schaltet bei Dämmerung automatisch Licht AN und am Morgen automatisch wieder AUS. Die Dämmerungsschwelle, bei der der Sensor reagiert und die Beleuchtung schaltet, definieren Sie natürlich selbst.

Un éclairage automatique. Le Interrupteur crépusculaire pour la commande des installations d'éclairage pour les façades de maison e il allume automatiquement la lumière au crépuscule et l'éteint automatiquement à l'aube. C'est naturellement à vous de définir le seuil de luminosité auquel doit réagir le détecteur et allumer la lumière.



97464 DETECT ME 3

motion detector; plastic, white
 Bewegungsmelder; Kunststoff, weiss
 détecteur de mouvement; plastique, blanc

L 100, H 100, A 55

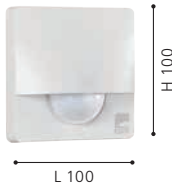

97466 DETECT ME 4

motion detector; plastic, white
 Bewegungsmelder; Kunststoff, weiss
 détecteur de mouvement; plastique, blanc

L 70, H 55, A 100

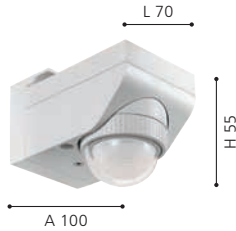

97421 DETECT ME 6

motion detector; plastic, white / plastic, white
 Bewegungsmelder; Kunststoff, weiss / Kunststoff, weiss
 détecteur de mouvement; plastique, blanc / plastique, blanc

Ø 90, A 55

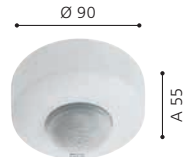

97465 DETECT ME 3

motion detector; plastic, black
 Bewegungsmelder; Kunststoff, schwarz
 détecteur de mouvement; plastique, noir

L 100, H 100, A 55

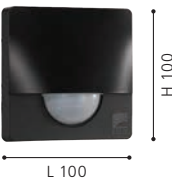

97467 DETECT ME 4

motion detector; plastic, black
 Bewegungsmelder; Kunststoff, schwarz
 détecteur de mouvement; plastique, noir

L 70, H 55, A 100



97422 DETECT ME 6

motion detector; plastic, black / plastic, white
 Bewegungsmelder; Kunststoff, schwarz / Kunststoff, weiss
 détecteur de mouvement; plastique, noir / plastique, blanc

Ø 90, A 55

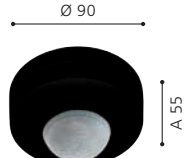



96452 DETECT ME 1

motion detector; plastic, white
 Bewegungsmelder; Kunststoff, weiss
 détecteur de mouvement; plastique, blanc

L 55, H 70, A 80

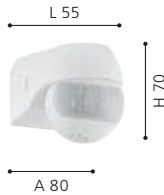

96454 DETECT ME 1

motion detector; plastic, black
 Bewegungsmelder; Kunststoff, schwarz
 détecteur de mouvement; plastique, noir

L 55, H 70, A 80



MOUNT ON CEILING



MOUNT ON WALL



MOUNT IN CORNER



MOUNT ON CORNER

Accessories incl.
 Zubehör inkl.
 Accessoires inclus



	DETECT ME 1	DETECT ME 3	DETECT ME 6	DETECT ME 4
MOUNT ON CEILING			•	•
MOUNT ON WALL	•	•		•
MOUNT IN CORNER				•
MOUNT ON CORNER				•
Accessories incl.				
				included see page 181
Delay	10 sec. - 15 min.	10 sec. - 15 min.	10 sec. - 15 min.	10 sec. - 15 min.
Detection range	12 m	12 m	12 m	12 m
Detection angle	180°	180°	360°	360°
Detection angle (horizontal)	+/- 40° horizontal 45° horizontal	+/- 30° horizontal +/- 90° vertical		
Light sensor	3 - 2000lx	3 - 2000lx	3 - 2000lx	3 - 2000lx
Load capacity	max. 800 W incandescent max. 400 W fluorescent	max. 1200 W incandescent max. 300 W fluorescent	max. 1200 W incandescent max. 300 W fluorescent	max. 1200 W incandescent max. 300 W fluorescent

Ideal mounting height / Ideale Montagehöhe / Hauteur de montage ideale: ~ 2m



93384 NEMA 1

ground spike; plastic, black / plastic, transparent
 Erdspieß; Kunststoff, schwarz / Kunststoff, transparent
 piquet de terre; plastique, noir / plastique, transparent

L 115, B 60, H 185

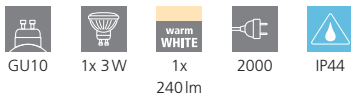

93385 NEMA 1

ground spike; plastic, black / plastic, transparent
 Erdspieß; Kunststoff, schwarz / Kunststoff, transparent
 piquet de terre; plastique, noir / plastique, transparent

L 115, B 115, H 180

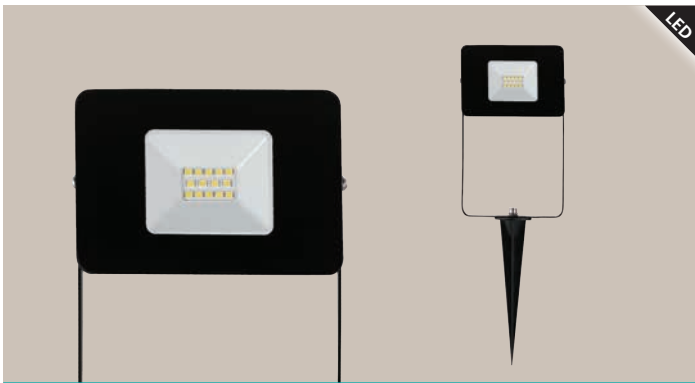
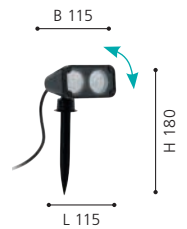
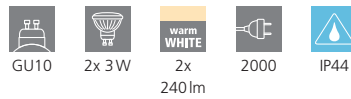

97471 FAEDO 4

ground spike; aluminium, black / glass, clear
 Erdspieß; Alu, schwarz / Glas, klar
 piquet de terre; aluminium, noir / verre, clair

L 115, B 35, H 310

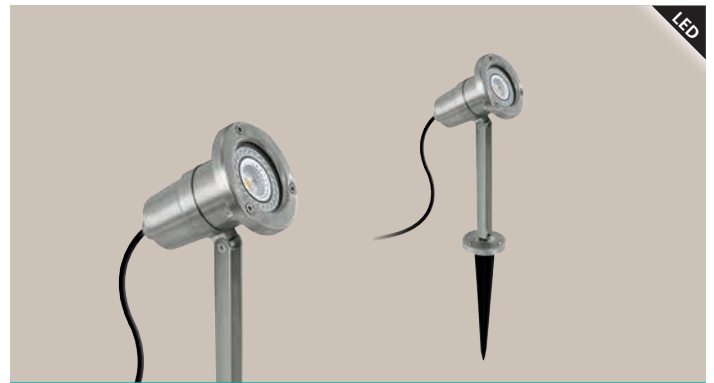
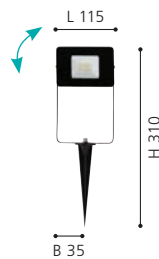

94111 NEMA

ground spike; stainless steel, stainless steel
 Erdspieß; Edelstahl, edelstahl
 piquet de terre; acier inoxydable, acier inoxydable

L 110, B 85, H 240, ET 165

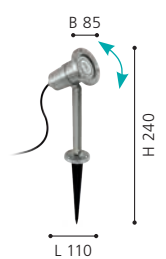

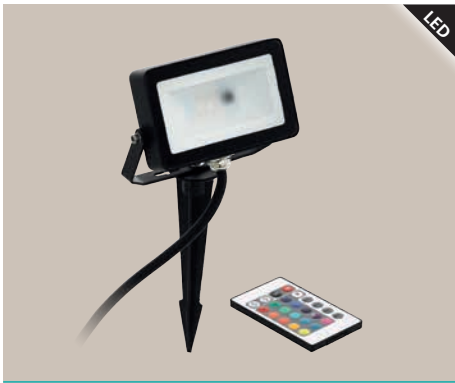

98185 FAEDO 4

flood light; aluminium, black / plastic, white
 Strahler; Alu, schwarz / Kunststoff, weiss
 projecteur; aluminium, noir / plastique, blanc

L 130, H 90, A 25

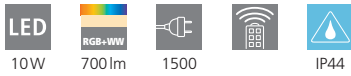

98183 PIERA 2

flood light; aluminium, plastic, silver, black / plastic, transparent
 Strahler; Alu, Kunststoff, silber, schwarz / Kunststoff, transparent
 projecteur; aluminium, plastique, argent, noir / plastique, transparent

L 165, B 105

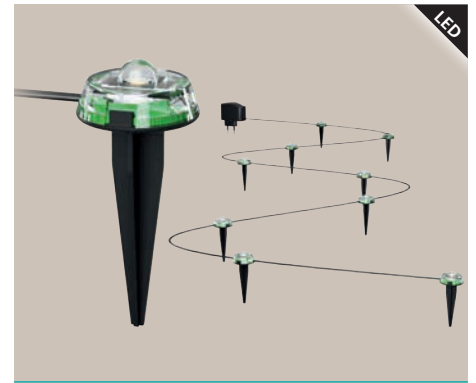

98184 SPINETOLI

ground spike; plastic, transparent / plastic, transparent
 Erdspieß; Kunststoff, transparent / Kunststoff, transparent
 piquet de terre; plastique, transparent / plastique, transparent

L 10000, B 30, H 10, ET 500



94111

NEMA comes with 3 different coloured bulb shades.

NEMA wird mit 3 verschiedenen farbigen Leuchtmittelabdeckungen ausgeliefert.

NEMA vient avec 3 couvercles d'ampoule en couleurs différentes.





97459 FAEDO 3

wall luminaire; aluminium, black / glass, clear
 Wandleuchte; Alu, schwarz / Glas, klar
 applique; aluminium, noir / verre, clair

L 110, H 135, A 50



97462 FAEDO 3

wall luminaire; aluminium, black / glass, clear
 Wandleuchte; Alu, schwarz / Glas, klar
 applique; aluminium, noir / verre, clair

L 175, H 190, A 50

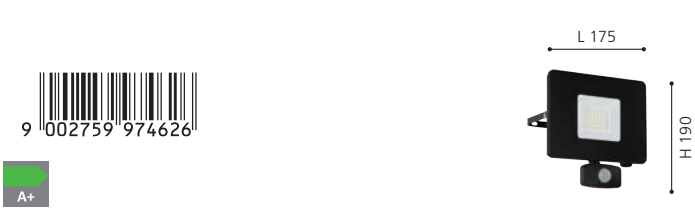

97461 FAEDO 3

wall luminaire; aluminium, black / glass, clear
 Wandleuchte; Alu, schwarz / Glas, klar
 applique; aluminium, noir / verre, clair

L 130, H 140, A 50



97463 FAEDO 3

wall luminaire; aluminium, black / glass, clear
 Wandleuchte; Alu, schwarz / Glas, klar
 applique; aluminium, noir / verre, clair

L 205, H 200, A 50





97463





97455 FAEDO 3

wall luminaire; aluminium, black / glass, clear
 Wandleuchte; Alu, schwarz / Glas, klar
 applique; aluminium, noir / verre, clair

L 110, H 80, A 30



10W 900lm IP65

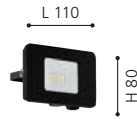

97456 FAEDO 3

wall luminaire; aluminium, black / glass, clear
 Wandleuchte; Alu, schwarz / Glas, klar
 applique; aluminium, noir / verre, clair

L 130, H 95, A 30



20W 1800lm IP65

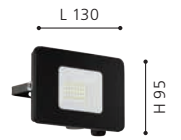

97457 FAEDO 3

wall luminaire; aluminium, black / glass, clear
 Wandleuchte; Alu, schwarz / Glas, klar
 applique; aluminium, noir / verre, clair

L 175, H 135, A 30



30W 2750lm IP65



97458 FAEDO 3

wall luminaire; aluminium, black / glass, clear
 Wandleuchte; Alu, schwarz / Glas, klar
 applique; aluminium, noir / verre, clair

L 205, H 145, A 30



50W 4800lm IP65





97458

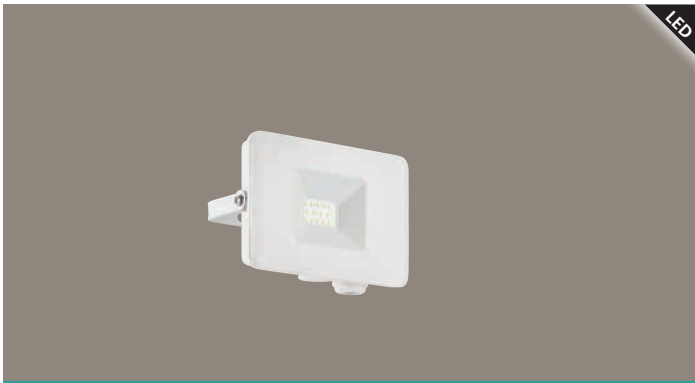

LED

33152 FAEDO 3

wall luminaire; aluminium, white / glass, clear
Wandleuchte; Alu, weiss / Glas, klar
applique; aluminium, blanc / verre, clair

L 110, H 80, A 30



10W 900lm IP65



9 002759 331528

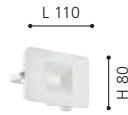

LED

33153 FAEDO 3

wall luminaire; aluminium, white / glass, clear
Wandleuchte; Alu, weiss / Glas, klar
applique; aluminium, blanc / verre, clair

L 130, H 95, A 30



20W 1800lm IP65



9 002759 331535

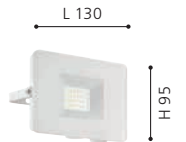

LED

33154 FAEDO 3

wall luminaire; aluminium, white / glass, clear
Wandleuchte; Alu, weiss / Glas, klar
applique; aluminium, blanc / verre, clair

L 175, H 135, A 30



30W 2750lm IP65



9 002759 331542

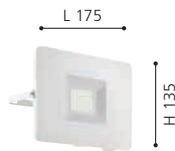

LED

33155 FAEDO 3

wall luminaire; aluminium, white / glass, clear
Wandleuchte; Alu, weiss / Glas, klar
applique; aluminium, blanc / verre, clair

L 205, H 145, A 30



50W 4800lm IP65



9 002759 331559

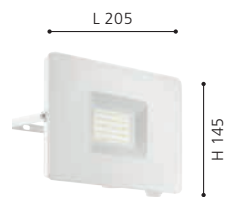



33156 FAEDO 3

wall luminaire; aluminium, white / glass, clear
 Wandleuchte; Alu, weiss / Glas, klar
 applique; aluminium, blanc / verre, clair

L 110, H 135, A 50

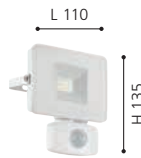

33157 FAEDO 3

wall luminaire; aluminium, white / glass, clear
 Wandleuchte; Alu, weiss / Glas, klar
 applique; aluminium, blanc / verre, clair

L 130, H 140, A 50



33158 FAEDO 3

wall luminaire; aluminium, white / glass, clear
 Wandleuchte; Alu, weiss / Glas, klar
 applique; aluminium, blanc / verre, clair

L 175, H 190, A 50



33159 FAEDO 3

wall luminaire; aluminium, white / glass, clear
 Wandleuchte; Alu, weiss / Glas, klar
 applique; aluminium, blanc / verre, clair

L 205, H 200, A 50



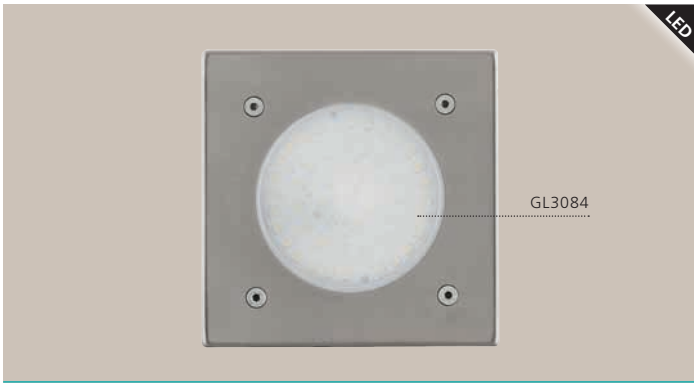

93481 LAMEDO

ground recessed luminaire; stainless steel, stainless steel / satin glass, white
 Bodeneinbauleuchte; Edelstahl, edelstahl / Glas satiniert, weiss
 luminaire encastrable au; acier inoxydable, acier inoxydable / verre satiné, blanc

L 100, B 100, ET 65

LED
 1x 2,5W
 warm WHITE
 1x
 180lm
 IP65/67



9 002759 934811

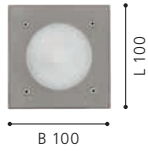

93482 LAMEDO

ground recessed luminaire; stainless steel, stainless steel / satin glass, white
 Bodeneinbauleuchte; Edelstahl, edelstahl / Glas satiniert, weiss
 luminaire encastrable au; acier inoxydable, acier inoxydable / verre satiné, blanc

Ø 100, ET 65

LED
 1x 2,5W
 warm WHITE
 1x
 180lm
 IP65/67



9 002759 934828



98182



98182 TRONTO

ground recessed luminaire; stainless steel, plastic, stainless steel, black / plastic, transparent
 Bodeneinbauleuchte; Edelstahl, Kunststoff, edelstahl, schwarz / Kunststoff, transparent
 luminaire encastrable au; acier inoxydable, plastique, acier inoxydable, noir / plastique, transparent

H 2, Ø 45, ET 50

LED
 1W
 warm WHITE
 65lm
 IP67



9 002759 981822



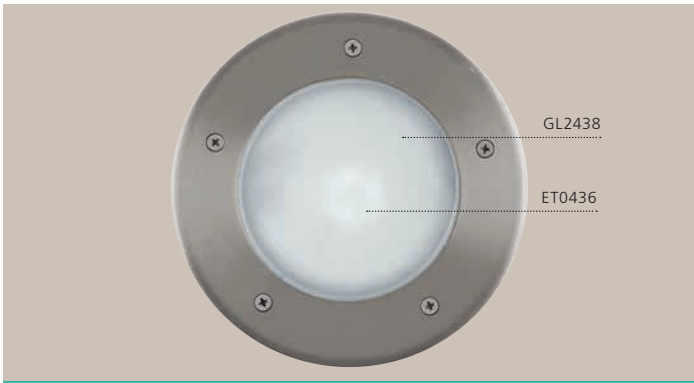

86189 RIGA 3

ground recessed luminaire; stainless steel, stainless steel / plastic, white
 Bodeneinbauleuchte; Edelstahl, edelstahl / Kunststoff, weiss
 luminaire encastrable au; acier inoxydable, acier inoxydable / plastique, blanc

H 285, Ø 170



E27 1x 15W IP67



9 002759 861896



Ø 170



LAMEDO & RIGA 3 & TRONTO

No more annoying cables in your garden: bury them simply and safely with the CONNECTOR BOX.

Mit der CONNECTOR BOX können Sie störende Kabel einfach und sicher unter der Erde verschwinden lassen.

Tous les câbles incommodants disparaissent simplement et sûrement dans votre jardin avec CONNECTOR BOX.

see page 198
 siehe Seite 198
 voir page 198



86189

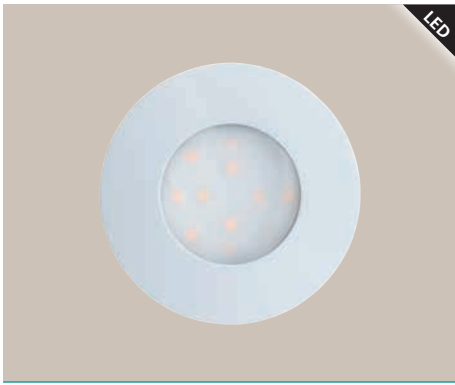

96414 PINEDA-IP

recessed luminaire; plastic, white
 Einbauleuchte; Kunststoff, weiss
 luminaire encastrable; plastique, blanc

Ø 78, ET 35



96416 PINEDA-IP

recessed luminaire; plastic, white
 Einbauleuchte; Kunststoff, weiss
 luminaire encastrable; plastique, blanc

Ø 102, ET 35

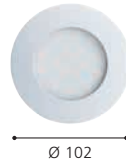

94093 MARGO

recessed luminaire; cast aluminium, white /
 satin glass, white
 Einbauleuchte; Aluguss, weiss / Glas satiniert, weiss
 luminaire encastrable; fonte d'aluminium, blanc /
 verre satiné, blanc

H 10, Ø 84, ET 125



96415 PINEDA-IP

recessed luminaire; plastic, satin nickel
 Einbauleuchte; Kunststoff, nickel-matt
 luminaire encastrable; plastique, nickel mat

Ø 78, ET 35

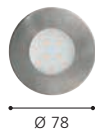

96417 PINEDA-IP

recessed luminaire; plastic, satin nickel
 Einbauleuchte; Kunststoff, nickel-matt
 luminaire encastrable; plastique, nickel mat

Ø 102, ET 35



94092 MARGO

recessed luminaire; cast aluminium, stainless steel /
 satin glass, white
 Einbauleuchte; Aluguss, edelstahl / Glas satiniert, weiss
 luminaire encastrable; fonte d'aluminium, acier inoxydable /
 verre satiné, blanc

H 10, Ø 84, ET 125

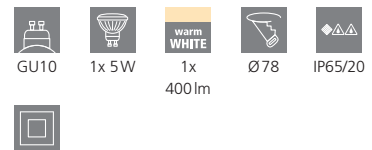

96417

IP20



IP65 / IP44

PINEDA IP & MARGO

These luminaires are protected with IP65 / IP44 on the frontside and IP20 on the backside.

Diese Leuchten sind mit IP65 / IP44 frontseitig und IP20 rückseitig geschützt.

Disposent d'un degré de protection élevé IP65 / IP44 en face avant et IP20 en face arrière pour l'utilisation.

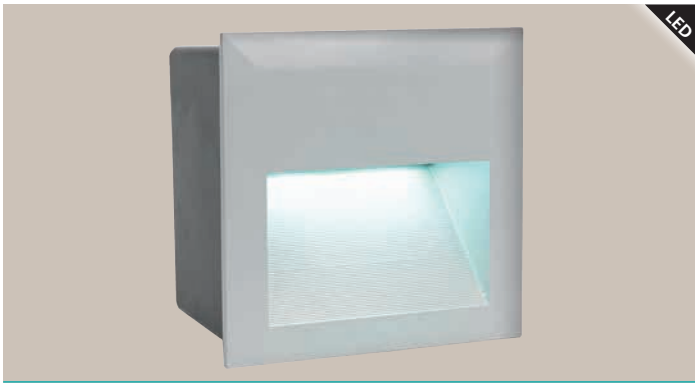

LED

95235 ZIMBA-LED

recessed luminaire; cast aluminium, silver
 Einbauleuchte; Aluguss, silber
 luminaire encastrable; fonte d'aluminium, argent

L 140, B 140, H 5, ET 95

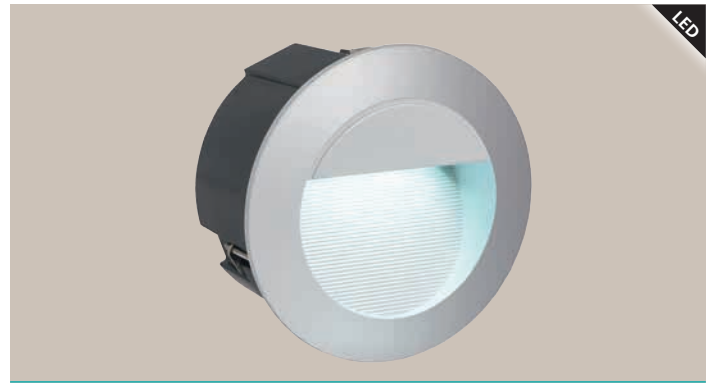
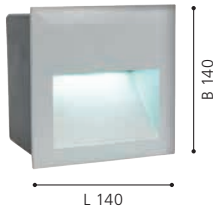

LED

95233 ZIMBA-LED

recessed luminaire; cast aluminium, silver
 Einbauleuchte; Aluguss, silber
 luminaire encastrable; fonte d'aluminium, argent

H 5, Ø 125, ET 95

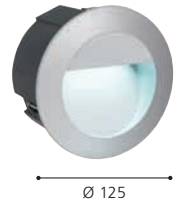

88008 ZIMBA

recessed luminaire; cast aluminium, silver / satin glass, white
 Einbauleuchte; Aluguss, silber / Glas satiniert, weiss
 luminaire encastrable; fonte d'aluminium, argent / verre satiné, blanc

L 243, B 101, H 5, ET 100

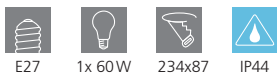

88575 ZIMBA

recessed luminaire; cast aluminium, silver / satin glass, white
 Einbauleuchte; Aluguss, silber / Glas satiniert, weiss
 luminaire encastrable; fonte d'aluminium, argent / verre satiné, blanc

L 227, B 127, H 13, ET 75

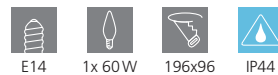



95235

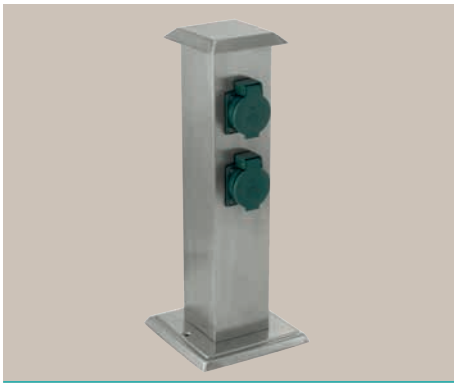

90748 PARK 4

accessory; stainless steel, stainless steel / plastic, green
Zubehör; Edelstahl, edelstahl / Kunststoff, grün
accessoire; acier inoxydable, acier inoxydable / plastique, vert

L 115, B 115, H 400, Base: B 160, T 160



IP44



9 002759 907488



93426 PARK 4

accessory; steel, plastic, black
Zubehör; Stahl, Kunststoff, schwarz
accessoire; acier, plastique, noir

L 115, B 115, H 400, Base: B 160, T 160



IP44



9 002759 934262



91206 CONNECTOR BOX

accessory; plastic, black
Zubehör; Kunststoff, schwarz
accessoire; plastique, noir

H 50, Ø 155



IP68



9 002759 912062

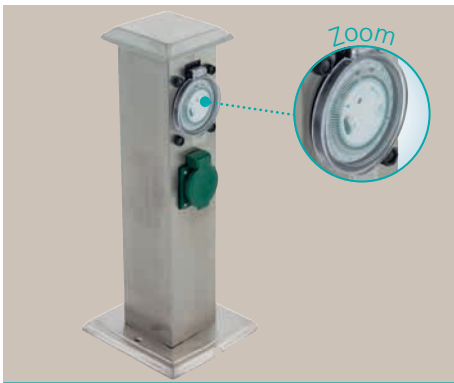

96351 PARK T

accessory; stainless steel, stainless steel / plastic, green
Zubehör; Edelstahl, edelstahl / Kunststoff, grün
accessoire; acier inoxydable, acier inoxydable / plastique, vert

L 115, B 115, H 400, Base: B 160, T 160



IP44



9 002759 963514

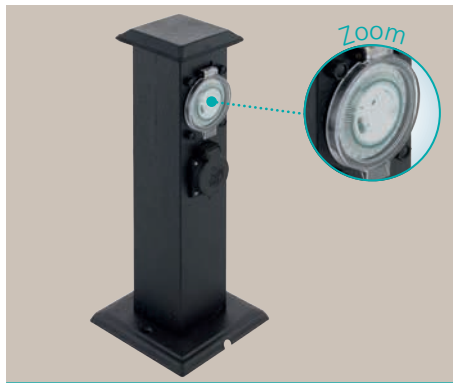

96352 PARK T

accessory; steel, plastic, black
Zubehör; Stahl, Kunststoff, schwarz
accessoire; acier, plastique, noir

L 115, B 115, H 400, Base: B 160, T 160



IP44



9 002759 963521



91207 CONNECTOR BOX

accessory; plastic, black
Zubehör; Kunststoff, schwarz
accessoire; plastique, noir

H 50, Ø 155



IP68



9 002759 912079





CONNECTOR BOX

No more annoying cables in your garden: bury them simply and safely with the CONNECTOR BOX.

91206: 1 supply line and
2 distribution lines

91207: 1 supply line and
5 distribution lines

Mit der CONNECTOR BOX können Sie störende Kabel einfach und sicher unter der Erde verschwinden lassen.

91206: 1 Zuleitung und
2 Verteilungsleitungen

91207: 1 Zuleitung und
5 Verteilungsleitungen

Tous les câbles incommodants disparaissent simplement et sûrement dans votre jardin avec CONNECTOR BOX.

91206: 1 alimentation et
2 lignes de distribution

91207: 1 alimentation et
5 lignes de distribution



96352, 96351

The Socket „Park T“ is equipped with a timer.

Die Steckdosensäule „Park T“ ist mit einer Zeitschaltuhr ausgestattet.

La colonne de sortie du „Park T“ est équipée d'une minuterie.



90748

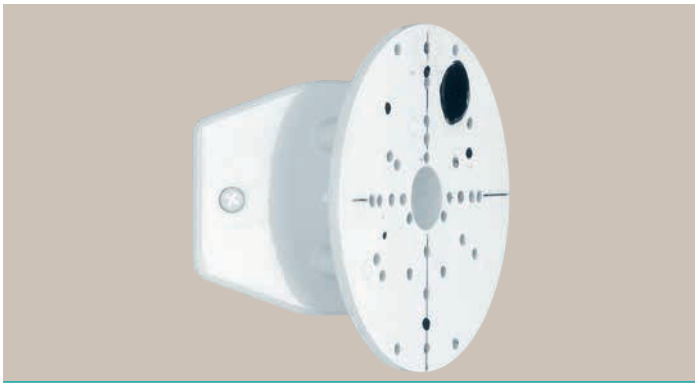

88152

accessory; steel, white
Zubehör; Stahl, weiss
accessoire; acier, blanc

H 50, Ø 112



88744 CUBA

ground spike; steel, zinc-plated
Erdspieß; Stahl, feuerverzinkt
piquet de terre; acier, galvanisé à chaud

H 300, Ø 185

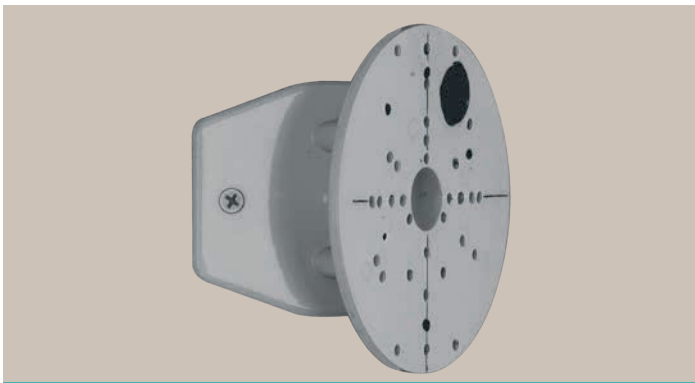
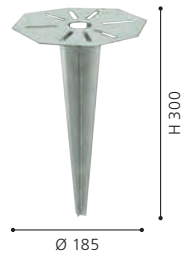

94112

accessory; steel, silver
Zubehör; Stahl, silber
accessoire; acier, argent

H 50, Ø 112

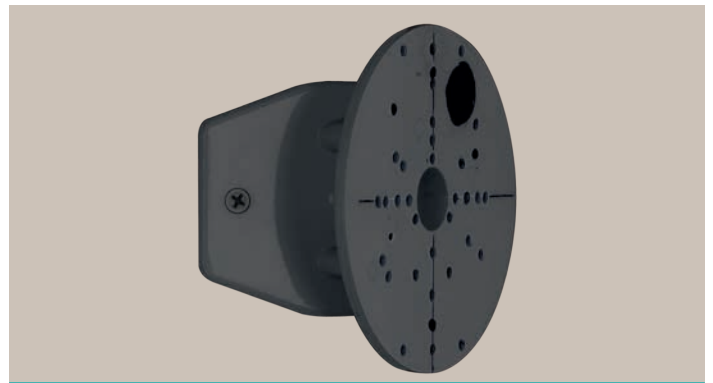

88153

accessory; steel, black
Zubehör; Stahl, schwarz
accessoire; acier, noir

H 50, Ø 112



88744

With the CUBA ground spike you can stick your floor luminaire in the ground or set it in concrete.

Mit dem CUBA Erdspieß können Sie Ihre Stehleuchte in den Boden stecken oder einbetonieren.

Avec le piquet de terre CUBA vous pouvez fixer votre lampadaire en sol ou au béton.

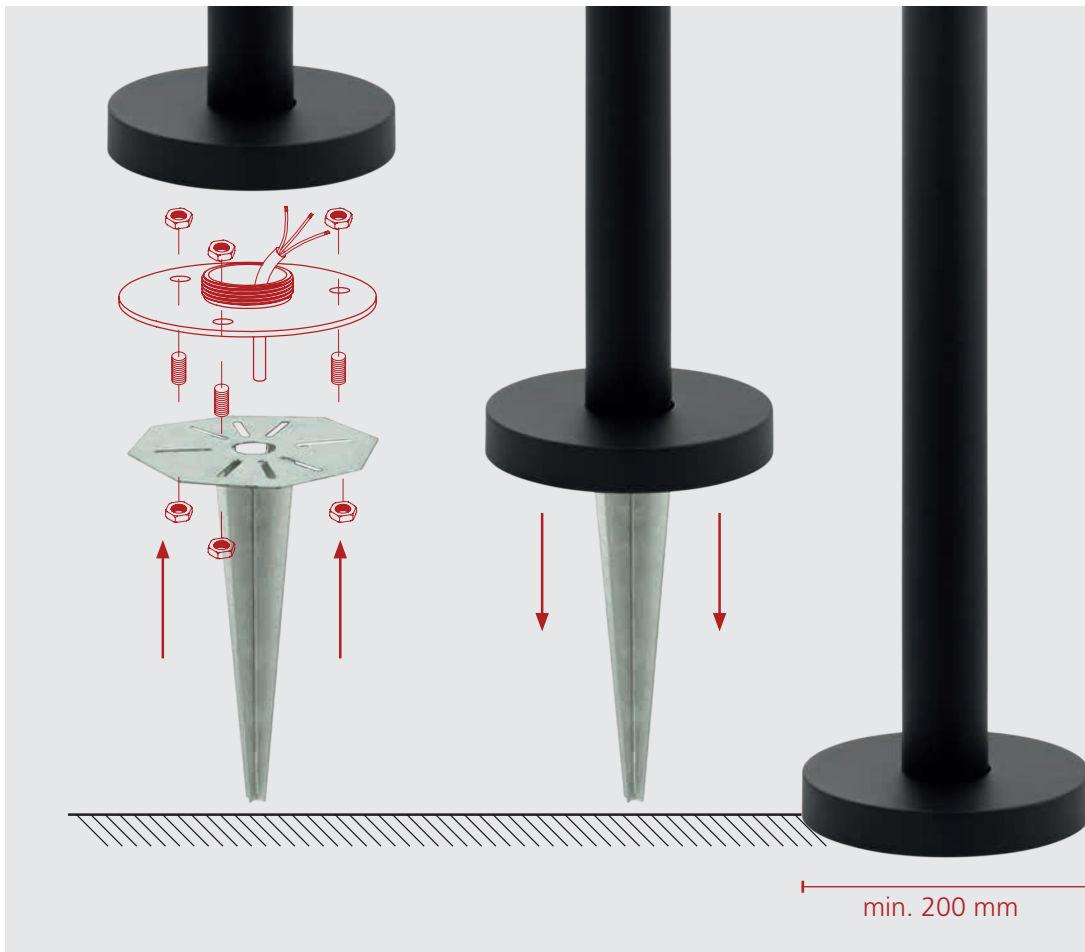

88152, 88153, 94112

The above mentioned pictogram indicates suitable luminaires which can be easily mounted on corners with this accessories.

Das oben gezeigte Piktogramm markiert passende Leuchten, welche mit dem Zubehör einfach an Ecken montiert werden können.

Le pictogramme ci-dessus marque les luminaires correspondant, qui peut être monté avec les accessoires simples dans les coins.



88152

GARDEN LIVING



OVERVIEW

GARDEN LIVING



MONTEROLO
204



MONTEROLO
204



MONTEROLO
204



MONTEROLO
204

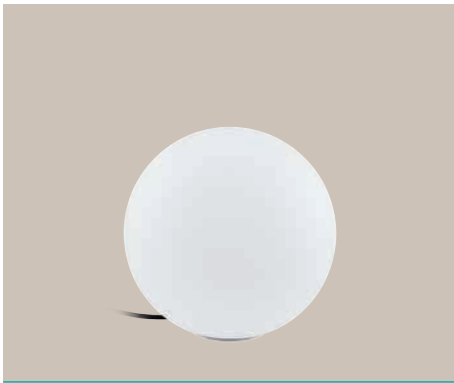

98101 MONTEROLO

floor luminaire; plastic, white / plastic, white
Stehleuchte; Kunststoff, weiss / Kunststoff, weiss
lampadaire; plastique, blanc / plastique, blanc

H 300, Ø 300, Base: Ø 120

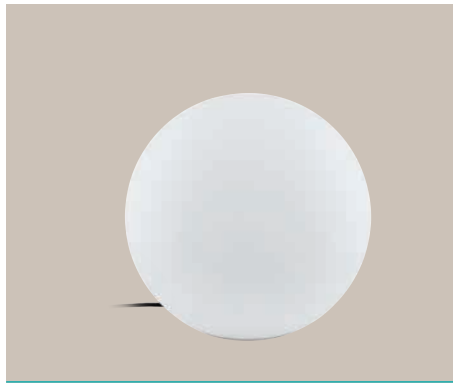
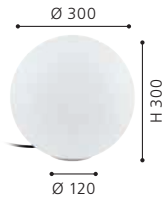

98102 MONTEROLO

floor luminaire; plastic, white / plastic, white
Stehleuchte; Kunststoff, weiss / Kunststoff, weiss
lampadaire; plastique, blanc / plastique, blanc

H 390, Ø 390, Base: Ø 195

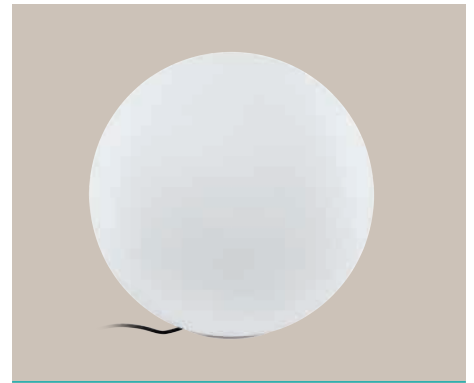
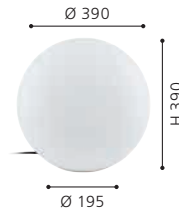

98103 MONTEROLO

floor luminaire; plastic, white / plastic, white
Stehleuchte; Kunststoff, weiss / Kunststoff, weiss
lampadaire; plastique, blanc / plastique, blanc

H 500, Ø 500, Base: Ø 195

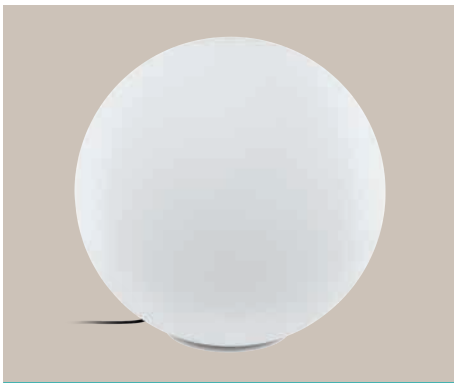
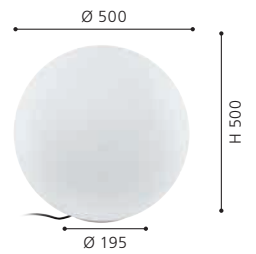

98104 MONTEROLO

floor luminaire; plastic, white / plastic, white
Stehleuchte; Kunststoff, weiss / Kunststoff, weiss
lampadaire; plastique, blanc / plastique, blanc

H 600, Ø 600, Base: Ø 195

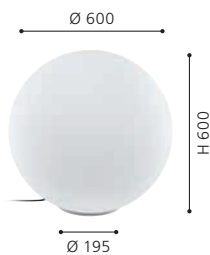
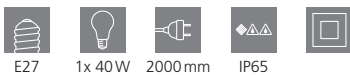



98102

98103

ENERGY EFFICIENCY LABELS

ENERGIEEFFIZIENZ-LABEL

LABEL DE L'EFFICACITÉ ÉNERGÉTIQUE

LED LUMINAIRES - are increasingly popular and the demand for energy-efficient solutions is gaining strength. This has resulted in the adoption of several EU regulations prescribing the energy efficiency labelling of light sources and luminaires. We have prepared a brief overview of the new energy labels.

LED LEUCHTMITTEL - sind am Vormarsch, der Ruf nach energieeffizienten Lösungen wird immer größer. In den letzten Jahren wurden daher mehrere EU-Verordnungen verabschiedet, die die Kennzeichnung der Energieeffizienz bei Leuchtmitteln und Leuchten vorschreibt. Hier finden Sie eine kurze Übersicht der neuen Energieeffizienzkennzeichnung.



LES ÉCLAIRAGES LED - gagnent du terrain, la demande de solutions efficaces en énergie ne cesse de croître. C'est la raison pour laquelle plusieurs directives européennes prescrivant le marquage de l'efficacité énergétique des moyens d'éclairage et des lampes ont été promulguées au cours de ces dernières années. Vous trouverez ici un bref aperçu d'ensemble des nouveaux marquages de l'efficacité énergétique.



The information in brackets at the centre of the label indicates which bulbs may be used for the luminaire. In this case, the product is only compatible with bulbs with an energy efficiency rating of better than C.

Die Klammer in der Mitte des Labels gibt an, mit welchen Leuchtmitteln die Leuchte kompatibel ist. In diesem Fall dürfen nur Leuchtmittel verwendet werden, deren Energieklasse effizienter als C ist.

La parenthèse au milieu du label indique les moyens d'éclairage avec lesquels la lampe est compatible. Il est seulement permis dans ce cas d'utiliser des moyens d'éclairage dont la classe d'énergie présente une efficacité supérieure à C.

If bulbs are included with the luminaire, their energy classes are indicated at the bottom of the label.

Falls Leuchtmittel inkludiert sind, wird deren Energieklasse im unteren Teil des Labels angegeben.

Si des moyens d'éclairage sont inclus, leur classe énergétique est indiquée dans la partie inférieure du label.



This label indicates that no bulbs are included with the luminaire. Consumers are free to choose their preferred bulb within the indicated energy classes.

Dieses Label wird verwendet, wenn die Leuchte ohne Leuchtmittel ausgeliefert wird. Der Kunde kann selber entscheiden, welches Leuchtmittel der angegebenen Klassen verwendet wird.

Ce label est utilisé lorsque la lampe est livrée sans ampoules. Le client peut décider lui-même quel ampoule des classes indiquées est utilisé.

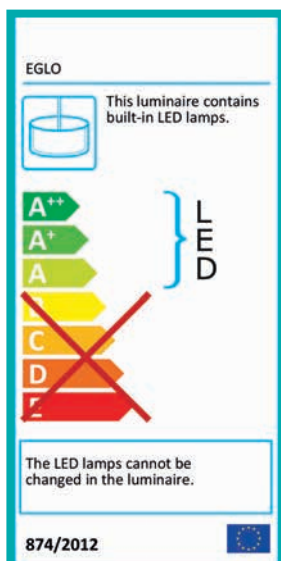

This label indicates that the luminaire is sold with built-in LED lamps that cannot be replaced by the consumer himself.

Dieses Label wird verwendet, wenn Leuchten mit LED-Modulen verkauft werden, die vom Endkunden nicht selbstständig ausgetauscht werden können.

Ce label est utilisé lorsque des lampes sont vendues avec des modules LED ne pouvant pas être changés par les clients finaux eux-mêmes.

EEL BUTTONS

bulbs included

inkl. Leuchtmittel | ampoules comprises



incl. highly efficient LED boards (cannot be replaced by the end consumer)

inkl. hocheffizienter LED Platinen (können nicht vom Endkonsumenten ausgetauscht werden)

incl. platines LED très efficaces (ne peuvent pas être remplacés par le consommateur final)



incl. highly efficient LED bulbs

inkl. hocheffizienter LED Leuchtmittel
ampoules à LED plus efficaces comprises



incl. efficient LED and/or fluorescent bulbs

inkl. effizienter LED und/oder Leuchtstoff-Leuchtmittel

ampoules à LED et/ou fluorescentes efficaces comprises



incl. halogen bulbs

inkl. Halogen-Leuchtmittel
ampoules halogènes comprises

bulbs not included

exkl. Leuchtmittel | ampoules non comprises



The luminaire is compatible with bulbs of all energy classes.

Die Leuchte ist mit Leuchtmitteln aller Energieklassen kompatibel.

compatible avec des ampoules de toutes les classes de l'énergie



The luminaire is only compatible with energy efficient bulbs.

Die Leuchte ist nur mit energieeffizienten Leuchtmitteln kompatibel.

compatible uniquement avec des ampoules économes en énergie

EGLO WORLDWIDE

EGLO WELTWEIT

EGLO DANS LE MONDE



 **HEADQUARTERS**
EGLO LEUCHTEN GMBH
Heiligkreuz 22
A-6136 PILL
T: +43 5242 6996 0 | F: +43 5242 6996 972
E: info-austria@eglo.com

 **CANADA**
EGLO CANADA INC.
20700 Route Transcanadienne
Baie-D'Urfé, Québec | H9X 4B7
T: +1 514 457 5483 | F: +1 514 457 5487
E: info-canada@eglo.com

 **CZECH REPUBLIC**
EGLO CZ+SK s.r.o.
Náchodská 2479/63
CZ-193 00 PRAHA 9 Horní Počernice
T: +420 281 924 163 | F: +420 281 925 205
E: info-czechrepublic@eglo.com

 **AUSTRALIA**
EGLO LIGHTING AUSTRALIA
5/339 Road
Richlands | Queensland 4077
T: +61 7 3375 1413 | F: +61 7 3375 1412
E: info-australia@eglo.com

 **CHILE - SANTIAGO**
EGLO CHILE ILUMINACION LTDA.
Av. Américo Vespucio 1930
Conchalí - SANTIAGO DE CHILE
T: +562 2 595 2222
E: info-chile@eglo.com

 **DENMARK**
EGLO DANMARK A/S
Agerbakken 20
DK-8362 Høring
T: +45 70 22 55 11 | F: +45 70 22 55 21
E: info-denmark@eglo.com

 **BELGIUM**
EGLO BELGIUM B.V.B.A.
Antwerpsesteenweg 247 | B-2950 Kapellen
Visit Address: Innovatiepark 20 |
4906 AA OOSTERHOUT (NL)
T: +32 3 250 60 80 | F: +32 3 219 80 67
E: info-belgium@eglo.com

 **CHINA**
DONGGUAN EGLO LIGHTING COMMERCIAL CO LTD
No.1 | Shangqiao Industrial Road | Shangqiao,
Dongcheng District
DONGGUAN CITY, GUANZHOU PROVINCE | CHINA
T: +86 769 2203 3866 | F: +86 769 2203 6866
E: info-china@eglo.com

 **ESTONIA**
MOODNE VALGUSTUS AS
Rävala pst. 7
EE-10143 TALLINN
T: +372 667 6670 | F: +372 631 3195
E: info-global@eglo.com

 **BOSNIA-HERZEGOVINA**
EGLO RASVJETA BH D.O.O.
Ormanica bb
BIH-76250 GRADACAC
T: +387 35 86 85 00 | F: +387 35 82 44 41
E: Info-Bosnia-Herzegovina@eglo.com

 **COLOMBIA**
EGLO COLOMBIA ILUMINACION SAS
AUTOPISTA NORTE KM 19 COSTADO LOTE 30
BOGOTÁ - CHIA
T: +57 (1) 744 2339
E: info-global@eglo.com

 **FINLAND**
EGLO FINLAND OY
Malminraitti 17A
00700 Helsinki
T: +358 20 7649 820 | F: +358 20 7649 821
E:

 **BRAZIL**
EGLO DO BRASIL LUMINÁRIAS LTDA.
Villa Lobos Park | Av. Queiroz Filho, 1.700,
Torre D, Sala 1, Vila Hamburguesa - São Paulo - Brasil
CEP: 05319-000, T: +55 11 4193 6980
F: +55 11 2337-3921 | E: Info-Brazil@eglo.com

 **COSTA RICA**
EGLO Costa Rica, Centro Comercial Calle Real local #8
Guachipilín de Escazú de la sucursal del BAC
San Jose 800 metros al norte San Jose Costa Rica.
T: +506-2289-4690, +506-2100-6384
E: Info-CostaRica@eglo.com

 **FRANCE**
EGLO FRANCE LUMINAIRE SARL
Z.A. Jeune Bois | 2 Rue de la Martinique
F-68274 WITTENHEIM
T: +33 389 6250 30 | F: +33 389 6250 49
E: info-france@eglo.com

 **BULGARIA**
EGLO BULGARIA EOOD
Main Road 5th kilometer,
Building KACHIKA, 8000 BOURGAS, Bulgaria
T: +359 56 960 403 | F: +359 56 53 05 95
E: info-bulgaria@eglo.com

 **CROATIA**
EGLO RASVJETA D.O.O.
Josipa Loncara 3
HR-10000 ZAGREB
T: +385 1 379 40 62 | F: +385 1 379 41 04
E: info-croatia@eglo.com

 **GERMANY**
EGLO LEUCHTEN HANDELS GMBH
Kleinbahnstr. 35
D-59759 ARNSBERG
T: +49 2932 6269 0 | F: +49 2932 6269 39
E: info-germany@eglo.com



GREECE
EGLO HELLAS A.E.
Sykias 2 and parodos dekeleias
ACHARNAI, GR-13679
T: +30 210 240 77 10 | F: +30 210 240 07 29
E: info-greece@eglo.com



MEXICO
EGLO MÉXICO ILUMINACIÓN S DE RL DE CV
Prolongación Avenida López Mateos Sur N°3561,
Fraccionamiento Los Gavilanes.
C.P. 45645, Tlajomulco de Zúñiga, Jalisco, México
T: +52 33 3687 20 95 | E: info-mexico@eglo.com



SERBIA
EGLO RASVETA DOO
Stefana Prvovenčanog 28
11000 BEOGRAD | SRBIJA
T: +381 11 3981 366 | F: +381 11 3981 389
E: info-serbia@eglo.com



GREAT BRITAIN
EGLO UK LTD.
Unit 12 Cirrus Park, Lower Farm Road, Moulton Park
Industrial Estate, NORTHAMPTON NN3 6UR
T: +44 1604 790 986 | F: +44 1604 670 282
E: info-greatbritain@eglo.com



MIDDLE EAST
EGLO LIGHTING MIDDLE EAST FZE
P.O. BOX 262073, LOB 6, OFFICE G18
JEBEL ALI, DUBAI, UAE
T: +97 148810080 | F: +97 148810081
E: info.me@eglo.com



SLOVAKIA
EGLO CZ+SK s.r.o
Náchodská 2479/63
CZ-193 00 PRAHA 9 Horní Počernice
T: +421 313 211 551 | F: +421 313 211 556
E: info-slovakia@eglo.com



HUNGARY - PRODUCTION & LOGISTICS
EGLO MAGYARORSZAG KFT.
Fő út. 155
H-3060 PASZTO
T: + 36 32 560 050 | F: +36 32 560 040
E: info-hungary@eglo.com



MOROCCO
EGLO MAGHREB LUMINAIRES SARL
219 Bd Med Zerkouni. Suite: 67
20330 CASABLANCA | Morocco
T: +212 522 988 005 | F: +212 522 256 167
E: info-global@eglo.com



SLOVENIA
EGLO RASVJETA D.O.O.
Josipa Lončara 3
HR-10000 ZAGREB
T: +386 158 093 18
E: info-slovenia@eglo.com



INDIA
EGLO INDIA PRIVATE LIMITED
A-307 Ansal Chamber-1, 3 Bhikaji Cama Place,
New Delhi-110066
T: +91 981 108 2205 | F: +91 999 961 0450
E: info-india@eglo.com



THE NETHERLANDS
EGLO VERLICHTING NEDERLAND B.V.
Innovatiepark 20
4906 AA OOSTERHOUT (NBR)
T: +31 162 48 28 30 | F: +31 162 48 28 40
E: Info-Netherland@eglo.com



SPAIN
EGLO ESPANA ILUMINACION S.L.
Avda. de Castilla 1 (Edf. Best Point) 2°-16A
San Fernando de Henares, E-28830 MADRID
T: +34 91 677 9044 | F: +34 91 677 0304
E: info-spain@eglo.com



ITALY
EGLO ITALIANA S.R.L.
Via Giotto, 4
I-31021 MOGLIANO VENETO (TV)
T: +39 041 45 66 232/245/251 | F: +39 041 45 74 066/071
E: info-italy@eglo.com



NORWAY
ELEKTRO-ARMATUR a.s
Bjørnerudveien 18
N-1266 OSLO
T: +47 2262 9000 | F: +47 2262 9040
E: info-norway@eglo.com



SWEDEN
EGLO SVERIGE AB
Honungsgatan 3
S-432 48 VARBERG
T: +46 340 623 505 | F: +46 340 623 605
E: info-sweden@eglo.com



KAZAKHSTAN
EGLO KAZAKHSTAN LLP
113, 3rd, Block 5A, Nurlı-Tau Business Centr,
Al-Farabi Avenue 7, 050059 Almaty, Kazakhstan
T: +7 727 293 25 20 | M: +7 701 727 6000
E: info-kazakhstan@eglo.com



PERU
EGLO PERU S.A.C
Avda. Santa Cruz No. 458 Distrito de San Isidro
Provincia y Departamento Lima, San Isidro - Lima
T: +51 1 4212 158
E: info-peru@eglo.com



SWITZERLAND
EGLO SCHWEIZ AG
Seetalstraße 142
CH-6032 EMMEN
T: +41 41 268 69 59 | F: +41 41 268 69 58
E: info-switzerland@eglo.com



KOSOVO
EGLO KOSOVA LLC
Lugisht e qytetit pn
20000 PRIZREN- KOSOVO
T: +377 44 2166 87 | Shop: +381 29 2442 84
E: info-kosovo@eglo.com



PHILIPPINES
EGLO Lighting Pilipinas Corp.
4/F One E-Com Center Building, Ocean Drive, Mall
of Asia Complex, Pasay City 1300 Philippines
T: +63 2 737 9419
E: info-global@eglo.com



TURKEY
Eglo Aydınlatma ithalat İhracat Ltd. Şti.
Eyüp Sultan Mah. Sekmen Cad. No:18/2
34855 SAMANDIRA, SANCaktepe / İSTANBUL
T: +90 216 311 09 -02 / -03 / -04 | F: +90 216 311 09 -05
E: info-turkey@eglo.com



LEBANON
EGLO Lebanon S.A.R.L
Damascus Road, Graizy Building - Basement No. 1
Aley city, Lebanon
T: +961 555 9125 | T: +961 555 9126
E: info-global@eglo.com



POLAND
EGLO POLSKA SP. Z.O.O.
Ul. Pulawska 479
02-844 WARSZAWA
T: +48 22 644 57 55 | F: +48 22 644 89 82
E: info-poland@eglo.com



USA
EGLO USA, INC.
3640 Royal South Parkway
ATLANTA, GEORGIA 30349
T: +1 404 477 5601 | F: +1 404 393 7053
E: info-usa@eglo.com



LITHUANIA
MOODNE VALGUSTUS AS
Rävala pst. 7
EE-10143 TALLINN
T: +370 652 49923 | T: +372 667 6670
E: info-lithuania@eglo.com



PORTUGAL
EGLO PORTUGAL ILUMINAÇÃO, LDA
Rua Fonte Parada, 125
PT-4595-434 SEROA-PAÇOS DE FERREIRA
T: +351 255 890 000 | F: +351 255 892 346
E: info-portugal@eglo.com



UKRAINE
EGLO UKRAINE LTD
bulv. Vatslav Havel 6/7A
UA-03680 KIEV
T: +38 044 463 98 41 | F: +38 044 468 84 67
E: info-ukraina@eglo.com



MAGYARORSZÁG – ÉRTÉKESÍTÉS
EGLO LUX KFT.
Fő út. 143/A
H-2120 DUNAKESZI
T: +36 27 341 353 | F: +36 27 341 409
E: info-hungary@eglo.com



ROMANIA
EGLO ROMANIA PRODEXIM SRL.
Str. Atomistilor nr. 1D
R-077125 MAGURELE - ILFOV - ROMANIA
T: +40 314 250 902 | F: +40 314 250 899
E: info-romania@eglo.com



MALAYSIA
EGLO ASIA SDN BHD
No. 13, Jalan Pelukis U1/46B, Temasya 18, Glenmarie,
40150 Shah Alam, Selangor Darul Ehsan, Malaysia
T: +6011 1050 2336 | F: +603 5567 9415
E: info-malaysia@eglo.com



RUSSIA
EGLO LIGHTING LLC
Varshavskoe shosse 35 | Building 1
RU-117105 | MOSCOW
T: +7495 789 4311 | F: +7495 789 4312
E: info-russia@eglo.com

LEGEND

BOX LAYOUT

BOXEN LAYOUT

BOÎTE DE MISE EN PAGE

ARTICLE NUMBER
ARTIKELNUMMER
NUMÉRO D'ARTICLE

SERIES NAME
SERIENNAME
NOM DE LA SÉRIE

DESCRIPTION
BESCHREIBUNG
DESCRIPTION

BUTTONS
BUTTONS
BOUTTONS

DIMENSIONS
DIMENSIONEN
DIMENSIONS

The product description is composed as follows:
luminaire type; enclosure material, enclosure colour / glass or shade material, glass or shade colour

Die Produktbeschreibung setzt sich wie folgt zusammen:
Leuchtenart; Gehäusematerial, Gehäusefarbe / Schirm- bzw. Glasmaterial, Schirm- bzw. Glasfarbe

La description du produit est composée comme suit:
type de luminaire; matériel de boîtier, couleur de boîtier / matériel de verre ou abat-jour, couleur de verre ou abat-jour

LED Lightcolour | LED Lichtfarbe | couleur de LED



EEL bulbs not included | Leuchtmittel exklusive | ampoules non comprises



EEL bulbs included | Leuchtmittel inklusive | ampoules comprises

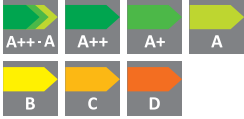

p.207

Colour Rendering Index | Farbwiedergabeindex | Indice de rendu de couleur de LED



Bulb included | Leuchtmittel inkludiert | ampoules inclus



Sensor included | Sensor inkludiert | Sensor inclus



Integrated Wifi | Integriertes Wifi | Wifi intégré



all dimensions in mm | alle Größen in mm | toutes dimensions en mm

L = length | Länge | longueur

B = width | Breite | largeur

H = height | Höhe | hauteur

Ø = diameter | Durchmesser | diamètre

A = projection length | Ausladung | amplitude

ET = installation depth | Einbautiefe | profondeur utile

Base = base dimensions | Sockelmaße | dimensions de base

Attention! The dimensions relate solely to the sizes of the luminaire. Any air spaces that would be relevant for a safe operating of the lamp were not considered.

Achtung! Die Größen beziehen sich nur auf die Abmessungen der Leuchte. Etwaige Lufträume, die für einen sicheren Betrieb der Leuchte notwendig sind, werden nicht berücksichtigt.





Attention! Les dimensions se réfèrent à la taille de la lampe seulement. Espacements éventuels, que seraient importants pour une opération de la lampe sans danger, n'ont pas été considérés.

SENSOR INCLUDED
SENSOR INKLUDIERT
SENSOR INCLUS

This symbol indicates luminaires with a sensor. In addition to the Detection angle, Reach, Time setting (min./max.) and Response brightness (lx) is indicated.

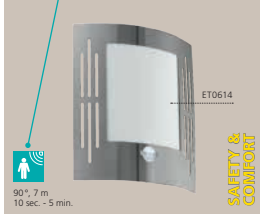
Ist die Leuchte mit einem Sensor ausgestattet, wird dies durch ein Sensorsymbol gekennzeichnet. Zusätzlich werden Erfassungswinkel, Reichweite, Zeiteinstellung (max./min.) und die Ansprechhelligkeit (lx) angegeben.

Un produit avec cette symbole ont une détecteur de mouvement. Aussi le angle de détection, la minuterie et Luminosité de déclenchement (lx) sont indiqué.

 <p>30191 CERNO wall luminaire; stainless steel, stainless steel / satin glass, white Wandleuchte; Edelstahl, edelstahl / Glas satiniert, weiss applique; acier inoxydable, acier inoxydable / verre satiné, blanc</p> <p>L 140, H 165, A 105</p> <p>E27 1x 40W IP44</p> <p>9 002759 301910</p> <p>A++-E</p>	 <p>88144 CITY wall luminaire; stainless steel, stainless steel / plastic, white Wandleuchte; Edelstahl, edelstahl / Kunststoff, weiss applique; acier inoxydable, acier inoxydable / plastique, blanc</p> <p>L 235, H 260, A 90</p> <p>E27 1x 60W IP44</p> <p>9 002759 881443</p> <p>A++-E</p>	 <p>88142 CITY wall luminaire; stainless steel, stainless steel / plastic, white Wandleuchte; Edelstahl, edelstahl / Kunststoff, weiss applique; acier inoxydable, acier inoxydable / plastique, blanc</p> <p>L 235, H 260, A 90</p> <p>E27 1x 60W IP44</p> <p>9 002759 881429</p> <p>A++-E</p>
 <p>30192 CERNO wall luminaire; stainless steel, stainless steel / satin glass, white Wandleuchte; Edelstahl, edelstahl / Glas satiniert, weiss applique; acier inoxydable, acier inoxydable / verre satiné, blanc</p> <p>L 140, H 190, A 110</p> <p>E27 1x 40W IP44</p> <p>9 002759 301927</p> <p>A++-E</p>	 <p>82309 CITY wall luminaire; stainless steel, stainless steel / plastic, white Wandleuchte; Edelstahl, edelstahl / Kunststoff, weiss applique; acier inoxydable, acier inoxydable / plastique, blanc</p> <p>L 235, H 260, A 90</p> <p>E27 1x 60W IP44</p> <p>9 002759 823092</p> <p>A++-E</p>	 <p>88139 CITY wall luminaire; stainless steel, stainless steel / plastic, white Wandleuchte; Edelstahl, edelstahl / Kunststoff, weiss applique; acier inoxydable, acier inoxydable / plastique, blanc</p> <p>L 235, H 260, A 90</p> <p>E27 1x 60W IP44</p> <p>9 002759 881399</p> <p>A++-E</p>

96 | MODERN

PICTOGRAMMES
PIKTOGRAMME
PICTOGRAMMES

Technical details are represented as pictograms. An overview over all pictograms can be found on the next pages.

Technische Details werden als Piktogramme dargestellt. Eine Übersicht über alle Piktogramme finden Sie auf den nächsten Seiten.

Les détails techniques sont représentés sous forme de pictogrammes. Vous trouverez un aperçu de tous les pictogrammes dans les pages suivantes.

SKETCHES
SKIZZEN
CROQUIS

The sketches state the most meaningful dimensions. If a product is adjustable by will, a turquoise arrow marks this function and only the maximum dimensions are indicated.

Die Bemaßung der Skizzen umfasst jeweils die aussagekräftigsten Größen. Bei verstellbaren Produkten kennzeichnet ein türkiser Pfeil diese Funktion und nur die maximalen Größen werden angegeben.

Les dimensions des croquis comprennent les plus représentatives. Si un produit est réglable au choix, une flèche turquoise affiche cette fonction et rien que les dimensions maximales sont indiquées.



30192

PRODUCT IN THE AMBIANCE
PRODUKTE IM AMBIENTE
PRODUITS DANS L'AMBIENCE

You can find the article number next to each product in the ambience pictures.

Sie finden die Artikelnummer neben jeder Abbildung des Produktes auf unseren Ambientebildern.

Vous pouvez trouver le numéro d'article à côté de chaque produit dans les images de l'ambiance.

SPARE PARTS
ERSATZTEILE
PARTS DE REMPLACEMENT

If spare parts for product are available they are marked on the photograph with their corresponding article number.

Wenn zu einem Produkt Ersatzteile vorhanden sind, werden diese in der Abbildung mit der entsprechenden Artikelnummer markiert.

Si un produit a des parts de remplacement, elles sont marquées avec le numéro d'article dans la photo.

MODERN | 97

LEGEND

PICTOGRAM PIKTOGRAMME PICTOGRAMME

SOCKETS FASSUNGEN DOUILLES

LED LED

 2G7

 2G11

 2GX13

 E14

 E27

 G4

 G5

 G9

 G10Q

 G13

 G23

 G53

 GU5,3 / MR16

 GU10

 GX53

 GY6,35

 R7s

BULBS LEUCHTMITTEL AMPOULES

 E14 / C35

 E14 / C35f

 E14 / D45

 E14 / C35f LED

 E14 / D45 Halogen

 E14 / C35 Halogen

 E14 / T22

 E14 / C35 Filament

 E14 / C37 Filament

 E14 / C35f Filament

 E14 / C37f Filament

 E14 / P45 LED

 E14 / P45 Filament

 E14 / P50

 E14 / ST48 Filament

 E14 / ST64 Filament

 E14 / T20 LED

 E27 / A60

 E27 / G90

 E27 / QR63

 E27 / A60 Halogen

 E27 / R63 Halogen

 E27 / A60 LED

 E27 / A60 Filament

 E27 / A65 LED

 E27 / A75 Filament

 E27 / G45 LED

 E27 / G45 Filament

 E27 / G80 Filament

 E27 / G95

 E27 / G95 Filament

 E27 / G125

 E27 / G95 LED

 E27 / R63 LED

 E27 / ST48 Filament

 E27 / ST64 Filament

 E27 / T30 Filament

 E27 / T32 Filament

 G4 / T9

 G4 / LT9

 G4 / LT14

 G9

 G9 LED

 GU10

 GU10 LED

 GU10 SMD LED

 GX53 / LF75

LED LED board / LED Platine / LED bord

 MR16

 MR16 LED

 R7s / 78mm

 R7s / 118mm

LIGHT COLOUR & LUMEN
LICHTFARBE & LUMEN
COULEUR LUMINEUX & LUMEN

The colours of the LED are represented as pictogrammes (see below), their luminous flux directly beneath. The luminous flux is quoted in lumen and describes the amount of light generated by the LED. The higher the value, the brighter is the lamp. Lumens are LED boards and are the light measurement value in bulbs.

Die Farben der LED werden als Piktogramm (siehe unten) dargestellt, deren Lichtstrom direkt darunter. Der Lichtstrom wird in Lumen gemessen und gibt die erzeugte Lichtmenge der LED an. Je höher der Wert, desto heller das Produkt. Lichtstromangaben (Lumen) sind Platinen- bzw. Leuchtmittelwerte.

Les couleurs de LED ont représentés sous forme de pictogrammes, leur flux lumineux directement en dessous. L'unité de flux lumineux est le lumen et il mesure la quantité de lumière générée par les LED. Plus la valeur est élevée, plus la lampe est lumineuse. Les lumens sont l'unité de mesure de l'intensité lumineuse des ampoules et des panneaux led intégrés.

	RGB RGB RGB		RGB + tunabel white RGB + tunabel white RGB + tunabel white
	RGB + white RGB + weiß RGB + blanc		tunable white tunable white tunable white
	RGB + warmwhite RGB + warmweiß RGB + blanc chaud		warm white warmweiß blanc chaud
	RGB + coldwhite RGB + kaltweiß RGB + blanc froid		cold white kaltweiß blanc froid
	RGB + neutralwhite RGB + neutralweiß RGB + blanc neutral		neutral white neutralweiß blanc neutre

SWITCHES & SENSORES
SCHALTER & SENSOREN
INTERRUPTEUR & CAPTEURS

	incl. cable & plug inkl. Kabel & Stecker câble & connecteur inclus		pedal switch Trittschalter interrupteur à pied		Dawn & Motion Sensor Helligkeits- & Bewegungs-Sensor Capteur de Luminosité & Detection de Mouvement
	internal dimmer eingebauter Dimmer variateur intégré		cable switch Kabelschalter interrupteur à câble		swedish plug Stecker Schweden connecteur swede
	button switch Druckknopf interrupteur de pression		incl. cable & plug transformer inkl. Kabel & Stecktransformator câble & transformateur à prise		"Touch me" ON/OFF "Touch me" EIN/AUS "Touch me" ON/OFF
	function switch Funktionsschalter interrupteur fonction		remote control Fernbedienung télécommande		"Touch me" ON/OFF & dimm "Touch me" EIN/AUS & Dimmen "Touch me" ON/OFF & graduable
	rocker switch Wippschalter interrupteur à bascule		Day & Night Sensor Tag & Nacht Sensor sensor jour & nuit		pull switch Zugschalter interrupteur à bascule
	pedal dimmer Trittdimmer variateur à pied		sensor Sensor sensor		Timer - automatic on/off Zeitschaltuhr - automatisches Ein- & Ausschalten minuterie - peut être éteint et allumé automatiquement

FUNKTIONEN & KOMFORT
FUNKTIONEN & KOMFORT
FONCTIONS & CONFORT

	incl. battery inkl. Akku incl. pile		cutout (in mm) Ausschnitt (in mm) perçage du panneau (en mm)		shortable kürzbar réductible
	incl. battery inkl. Batterie incl. pile		dimmable dimmbar graduable		Voltage Volt Voltage
	battery specifications Batteriespezifikationen spécifications des piles		not dimmable nicht dimmbar ne pas graduable		Watt
	beam angle Ausstrahlwinkel angle de rayonnement		replaceable LED austauschbare LED LED remplaçables		Camera Kamera Caméra
	corner mount possible Eckmontage möglich montage en coin possible		loadable in kg belastbar in kg chargeable en kg		Push notification Push Benachrichtigung Notification apparaissant
	Colour Rendering Index		packaging / delivery unit Verpackungs- / Liefereinheit unité d'emballage / de livraison		Internal memory Interner Speicher Mémoire interne

PROTECTION CLASS
SCHUTZKLASSE
CLASSE DE PROTECTION

The protection class indicates to what extent the lamp is protected against electric shock. All lamps in this catalogue are at least protected with the protection class 1 - a higher class is specified in the information box of the respective lamp.

Die Schutzklasse gibt an, inwiefern ein Produkt gegen einen elektrischen Schlag gesichert ist. Alle Leuchten in diesem Katalog sind mit mindestens Schutzklasse 1 gesichert, bei höheren Klassen wird das Symbol im Infokasten der Leuchte angegeben.

La classe de protection indique, dans quelle mesure la lampe est protégée contre les chocs électriques. Tous les lampes dans ce catalogue sont protégés au moins avec la classe 1 - une classe plus élevée est indiquée dans l'information de la lampe.

	protection class 1: protective earthing Schutzklasse 1: Schutzerdung classe de protection 1: prise de terre		protection class 2: protective insulation Schutzklasse 2: Schutzisolierung classe de protection 2: double isolation ou renforcée		protection class 3: protective low voltage Schutzklasse 3: Schutzkleinspannung classe de protection 3: très basse tension de sécurité
--	---	--	--	--	---

PROTECTION RATING
SCHUTZGRAD
INDICE DE PROTECTION

The protection rating ensures the operational safety of luminaires. The first number specifies the extent of the protection against the ingress of foreign bodies; the second number identifies the humidity protection grade. All luminaires in this catalogue are at least protected with the rating IP20 - a higher rating is specified in the information box of the luminaire.

Der Schutzgrad gewährleistet die Betriebssicherheit von Leuchten. Die erste Ziffer des IP Grades beschreibt den Schutzzumfang gegen das Eindringen von Fremdkörpern, die zweite Ziffer informiert über den Grad des Feuchtigkeitsschutzes. Alle Leuchten in diesem Katalog sind mit mindestens Schutzgrad IP20 gesichert, bei höheren Graden wird das Symbol im Infokasten der Leuchte angegeben.

L'indice de protection assure la sécurité opérationnelle des luminaires. Le premier chiffre indique à quel point la protection est efficace contre l'insertion de corps étrangers; le second chiffre indique quant à lui le degré de protection par rapport à l'humidité. Tous les luminaires dans ce catalogue sont protégés au moins avec l'indice IP20 - un indice plus élevé est indiqué dans l'information d'article.

	IP33		IP44		IP54		IP65		IP67
--	------	--	------	--	------	--	------	--	------

REGISTER

SERIES NAMES
SERIENNAMEN
NOME DE PRODUITS

NAME NAME NOM	PAGE SEITE PAGE	NAME NAME NOM	PAGE SEITE PAGE	NAME NAME NOM	PAGE SEITE PAGE	NAME NAME NOM	PAGE SEITE PAGE
ABRANTES	111	CITY	96	LEPUS	100	PAGINO	176
ACATE	98	COLINDRES	142	LISIO	156-157	PALIZZI	178
AGOLADA	87	COMUNERO 2	150	LM_LED_E27	18,181	PARETTA	125
AIROLA	139,143	CONNECT SENSOR	14	LOCANA-C	14	PARK	94
ALAMONTE	125	CONNECTOR BOX	198	LORMES	103	PARK 4	198
ALAMONTE 1	126-127	CORNALE	42	LUNANO	180	PARK T	198
ALBACETE	135,144	CUBA	200	MANERBIO	160-161	PASTION	178
ALORIA	152-155	CULPINA	45	MANFRIA	40	PAULLO	130
AMAROSI	44	DARIL	78	MANFRIA-HD	40	PENALVA	68
ANOLA	103	DESELLA 1	115	MARCHESA	56	PERAFITA	89
ARDIANO		DETECT ME 1	183	MARCHESA-C	17	PERNATE	55
ARGOLIS	80,90	DETECT ME 3	182	MARCHESA-HD	56	PIAS	99
ARGOLIS-C	15	DETECT ME 4	182	MARGO	194	PIERA 2	185
ATOLLARI	52	DETECT ME 5	181	MAZZINI	53	PILONE	81
AZZINANO	79	DETECT ME 6	182	MELGOA	138,143	PINEDA-IP	194
BARROSELA	135,138,142	DONINNI		MELZO	50-51	PIOVE-C	14
BASALGO 1	60	DONINNI 1	48-49	MERLITO	70	POLIENTO	58
BELCREDA	112	EMOLLIO	113	MILTON	100,144,157	PONSO	42
BEVERLY	70	ENTRIMO	100,139	MONREALE	146,148	PREDAZZO	84
BEVERLY 1	118	FAEDO 3	186,188,190-191	MONSELICE	160-161	PROPENDA	110
BINASCO	93	FAEDO 4	184-185	MONTEROLO	204	PULFERO	137
BIOSGA	55	FAVRIA	76	MONTEROLO-C	22-23	PULFERO 1	137
BOSARO	86	FAVRIA 1	76	MONTEROS	43	RALORA	98
BOVOLONE	141	FIUMICINO	46	MONTEVECCHIO-HD	146	RALORA 1	98
BREGANZO	94	FRANCARI	54	MORINO	84	REDONDO	85
BREGANZO 1	94	FRANCARI-C	17	MOUNA	157	RIGA	72-73
BRIONES	118	GISOLA	109	MUSSOTTO	79	RIGA 3	193
CALDIERO	66-67	GORZANO	84	NADELA	93	RIGA 5	72
CALDIERO-C	19	HELSINKI	64-65	NAVEDO	166,168-170	RIGA-LED	70-71
CALGARY 1	99	HILBURN	132	NEMA	184	ROALES	116
CALPINO	114	HILBURN 1	134-135	NEMA 1	184	ROBLEDO	69
CANOVE	140	INFESTO 1	91	NEMA 1-C	23	SAKEDA	108
CANTZO	115	IPHIAS	117	NISIA	62	SAN TELMO	144
CASABAS	176,178	JORBA	88	NISIA-C	20	SESIMBA	82
CERNO	96	KIBEA	93	ONCALA	63	SESIMBA 1	82
CHEIRA	118	LAMEDO	192	ONJA	102	SEVILLA	100
CICERONE	56	LATERNA 4	162-163	ONTANEDA	80	SIDNEY	158
CISTIerna	75	LATERNA 5	164-165	OROPOS	79	SIRMIONE	128

NAME NAME NOM	PAGE SEITE PAGE
SITIA	92
SONCINO	125
SONELLA	90
SOSPIRO	139
SOSSANO	160-161
SPINETOLI	185
STOCKHOLM 1	69
TABO	98
TABO-LED	99
TONEGO	74
TORAZZA-C	16
TRECCATE	140
TRIBANO	78
TRONO STICK	78
TRONTO	192
VALDEO	141,144
VENTO 1	80
VENTO 2	80
VERLUCCA	131
VERLUCCA-C	21
VERRES	79
VERRES-C	18
VILLAGRAZIA	124
ZIMBA	196
ZIMBA-LED	196



REGISTER

ARTICLE NUMBER
ARTIKELNUMMER
NUMÉROS D'ARTICLE

NUMBER NUMMER NUMÉRO	PAGE SEITE PAGE	NUMBER NUMMER NUMÉRO	PAGE SEITE PAGE	NUMBER NUMMER NUMÉRO	PAGE SEITE PAGE	NUMBER NUMMER NUMÉRO	PAGE SEITE PAGE	NUMBER NUMMER NUMÉRO	PAGE SEITE PAGE	NUMBER NUMMER NUMÉRO	PAGE SEITE PAGE	NUMBER NUMMER NUMÉRO	PAGE SEITE PAGE
11585	13	83589	144	93446	170	94805	138	96207	139	97228	130	97422	182
11586	23	83966	158	93447	170	94811	68	96237	79	97229	130	97445	131
11671	23	83969	158	93448	170	94812	68	96239	141	97237	14	97446	21
11684	18	83971	158	93451	170	94827	125	96241	144	97238	79	97447	21
11714	181	86189	193	93452	169	94831	126	96255	88	97239	18	97451	67
22144	162	86541	70	93453	169	94832	126	96256	88	97241	114	97452	66
22145	162	87105	158	93454	169	94833	126	96262	144	97242	114	97453	66
22462	165	88008	196	93455	166	94834	137	96263	135	97244	131	97454	66
22463	165	88119	100	93456	166	94837	142	96274	113	97245	131	97455	188
22464	165	88139	96	93457	166	94838	142	96275	113	97246	139	97456	188
22465	164	88142	96	93458	166	94841	137	96276	52	97247	20	97457	188
22466	165	88144	96	93459	166	94842	132	96277	52	97248	20	97458	188
22467	163	88152	200	93462	166	94843	132	96281	116	97249	20	97459	186
22468	163	88153	200	93463	168	94844	132	96282	116	97251	109	97461	186
22469	163	88489	100	93464	168	94845	98	96286	108	97252	109	97462	186
22471	162	88575	196	93465	168	94848	82	96287	108	97253	109	97463	186
22472	163	88744	200	93481	192	94854	137	96288	108	97254	81	97464	182
22995	164	88802	103	93482	192	94855	137	96351	198	97255	81	97465	182
22996	164	89767	102	93991	86	94858	142	96352	198	97256	161	97466	182
27126	62	89768	102	93994	84	94859	135	96365	80	97257	160	97467	182
30173	78	90184	144	94086	98	94863	143	96402	157	97258	161	97471	184
30184	156	90748	198	94092	194	94864	132	96414	194	97259	160	97475	14
30185	157	90867	100	94093	194	94865	135	96415	194	97261	141	97477	125
30186	156	91206	198	94099	73	94866	135	96416	194	97284	78	97478	125
30187	156	91207	198	94101	73	94867	135	96417	194	97285	128	97482	19
30188	156	92736	70	94102	73	94868	134	96452	183	97286	128	97483	19
30191	96	93094	155	94103	73	94871	90	96454	183	97287	128	97484	19
30192	96	93095	155	94104	73	94872	90	96488	117	97288	128	97485	19
30205	62	93096	155	94105	73	94877	91	96489	117	97289	42	97631	50
30206	62	93097	153	94106	72	95016	58	96491	80	97294	125	97632	50
30207	62	93098	153	94107	72	95017	58	96492	80	97295	14	97843	70
32732	14	93099	153	94111	184	95018	58	96494	90	97296	140	97844	70
32898	72	93254	93	94112	200	95076	111	96495	90	97297	118	98029	146
32899	72	93268	69	94114	99	95079	118	96504	71	97299	14	98052	23
33143	139	93318	84	94121	80	95097	115	96505	71	97301	51	98085	75
33144	143	93319	84	94127	78	95233	196	96583	103	97302	50	98086	75
33152	190	93364	99	94128	78	95235	196	96584	103	97303	51	98087	45
33153	190	93365	99	94137	94	95982	63	97117	42	97304	50	98088	45
33154	190	93367	85	94138	94	95987	92	97119	74	97307	55	98091	44
33155	190	93368	85	94186	98	95988	92	97144	53	97308	55	98092	44
33156	191	93384	184	94277	60	95989	98	97145	53	97311	112	98094	40
33157	191	93385	184	94278	60	96006	89	97146	67	97312	112	98095	40
33158	191	93402	154	94279	60	96007	89	97147	66	97313	76	98096	40
33159	191	93403	155	94281	60	96008	110	97148	55	97314	76	98097	40
81751	64	93404	154	94779	86	96009	110	97153	160	97315	76	98098	40
81752	64	93405	154	94784	80	96011	110	97154	115	97316	76	98101	204
81753	65	93406	152	94785	80	96012	110	97155	161	97335	150	98102	204
82309	96	93407	153	94788	127	96013	69	97158	93	97336	150	98103	204
83278	65	93408	152	94789	126	96017	94	97159	79	97337	150	98104	204
83279	64	93409	152	94792	138	96018	94	97218	79	97338	150	98105	22
83281	64	93426	198	94796	82	96019	82	97219	16	97339	180	98106	22
83432	94	93438	93	94799	118	96021	82	97222	84	97418	181	98107	22
83433	94	93444	170	94803	87	96022	82	97226	140	97419	181	98108	23
83588	157	93445	170	94804	87	96206	100	97227	130	97421	182	98115	148

NUMBER
NUMMER
NUMÉRO

PAGE
SEITE
PAGE

98116	148
98117	148
98118	148
98119	146
98121	146
98122	146
98123	146
98127	56
98128	56
98143	43
98144	43
98145	17
98146	56
98147	56
98148	46
98149	46
98151	46
98152	46
98153	124
98154	124
98171	15
98172	15
98173	15
98174	15
98175	176
98176	176
98177	176
98178	176
98182	192
98183	185
98184	185
98185	185
98187	178
98189	176
98191	178
98194	176
98195	178
98196	178
98232	54
98233	54
98234	17
98266	48
98267	48
98268	48
98269	48
98271	48
98272	49
98273	126



NOTES

NOTIZEN
NOTES

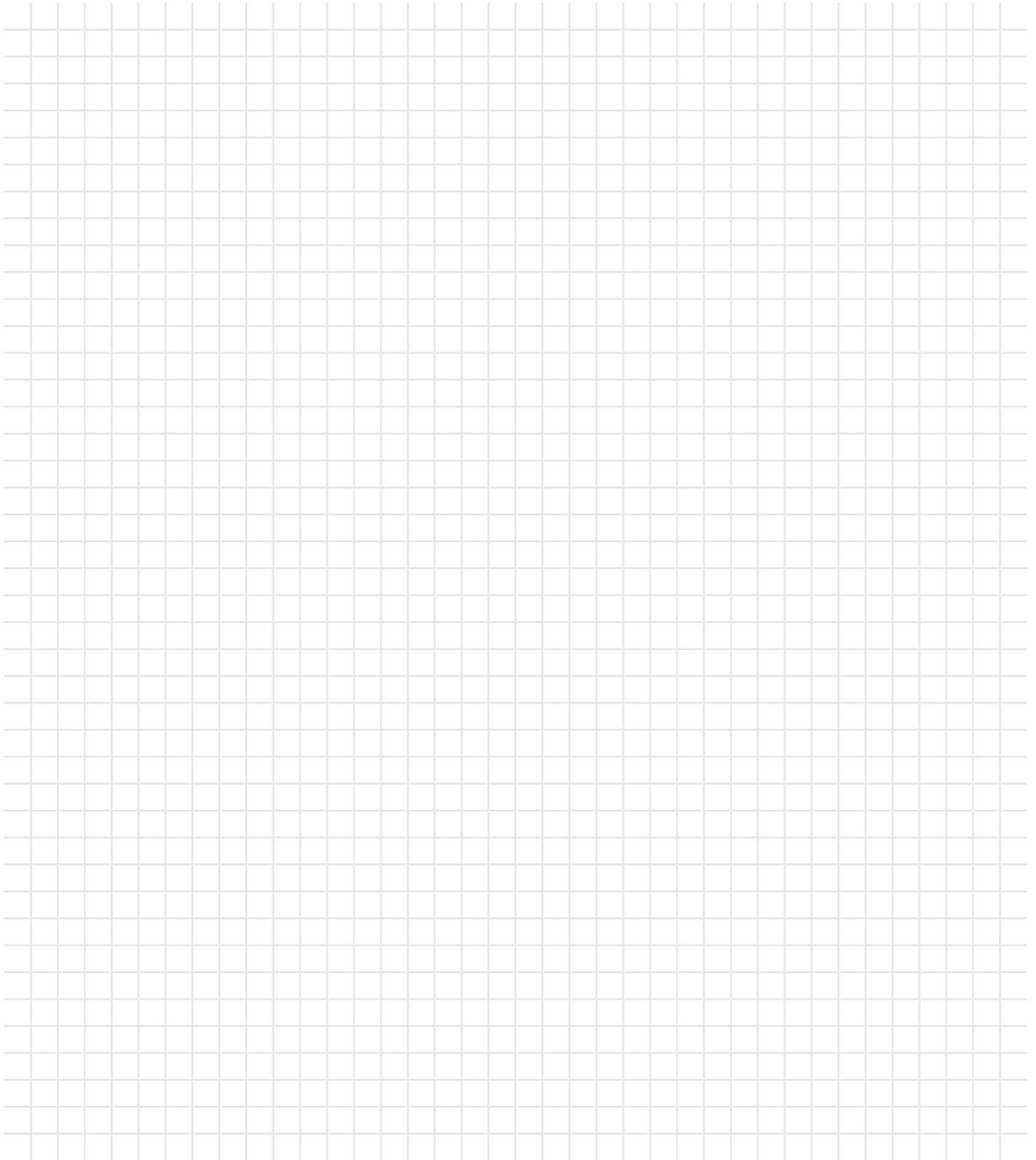

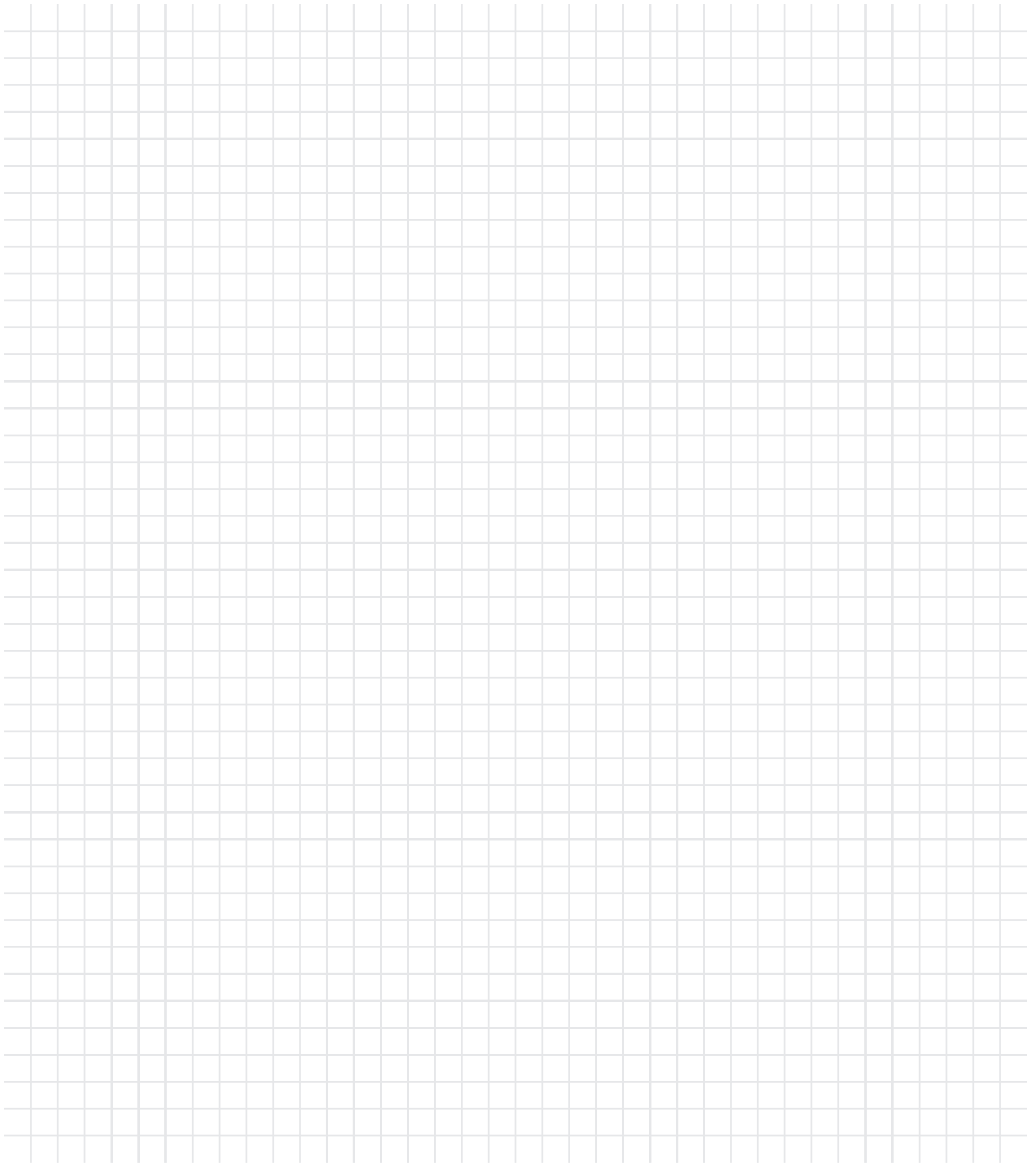

NOTES

NOTIZEN
NOTES

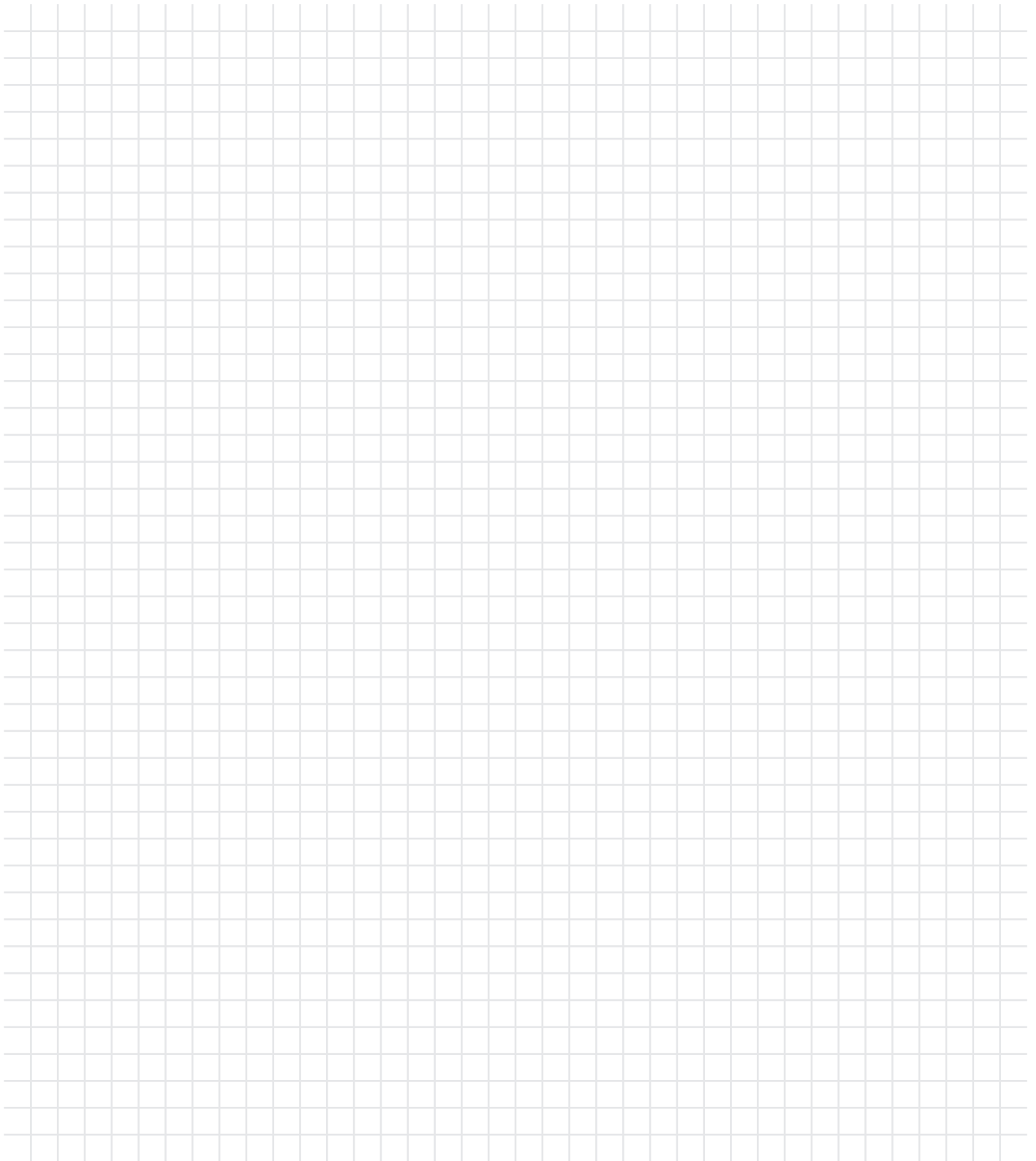

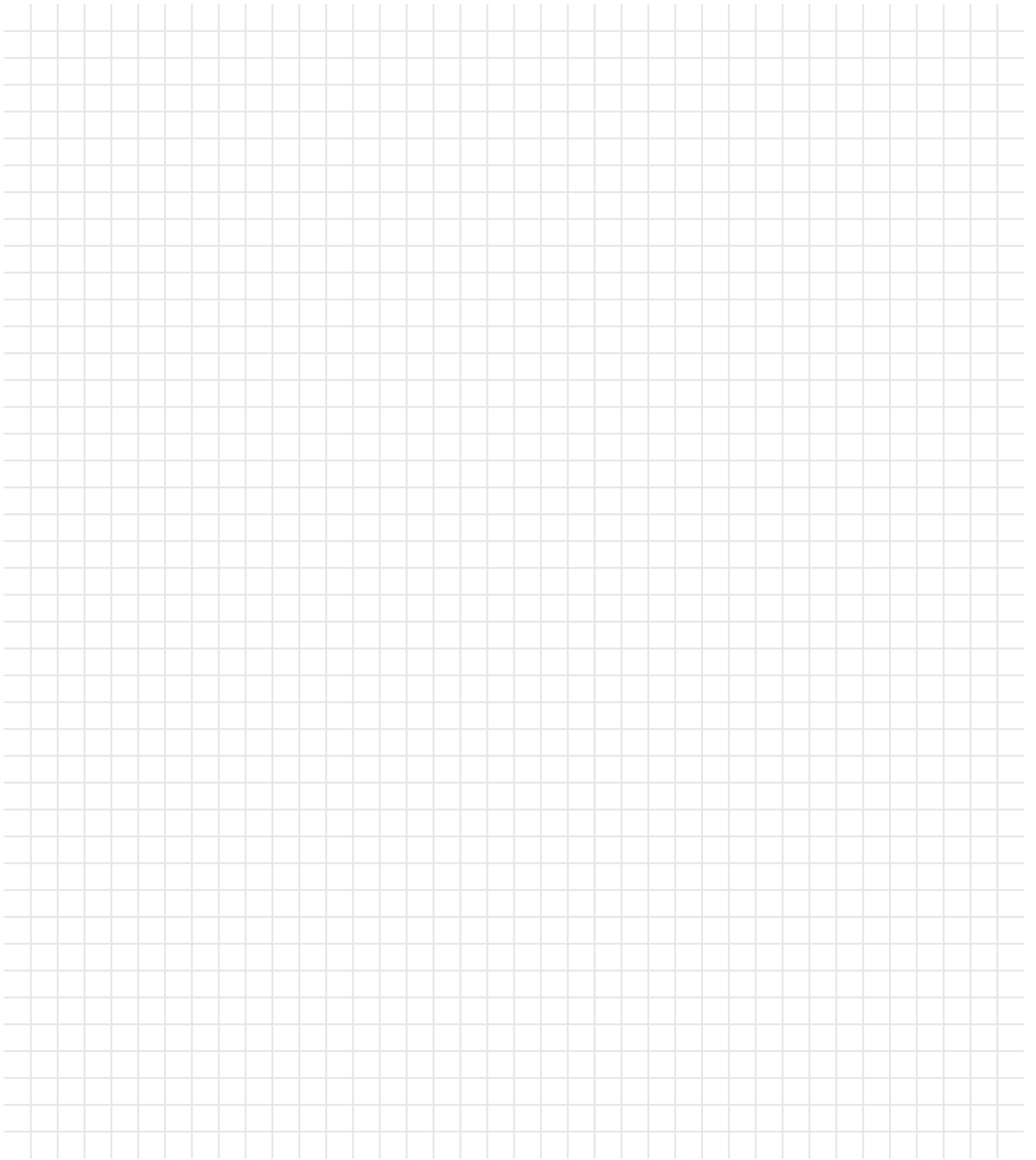

NOTES

NOTIZEN
NOTES

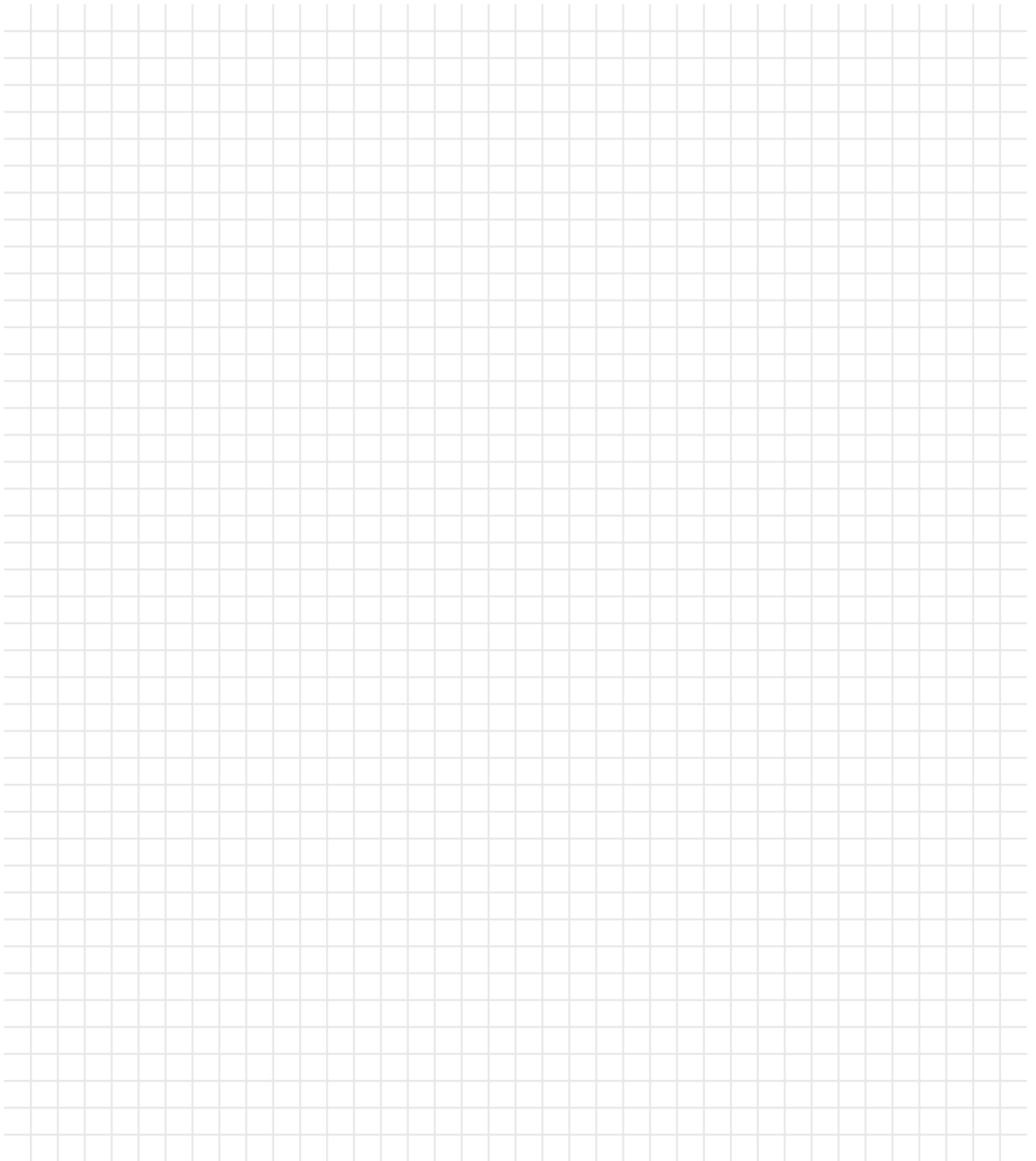

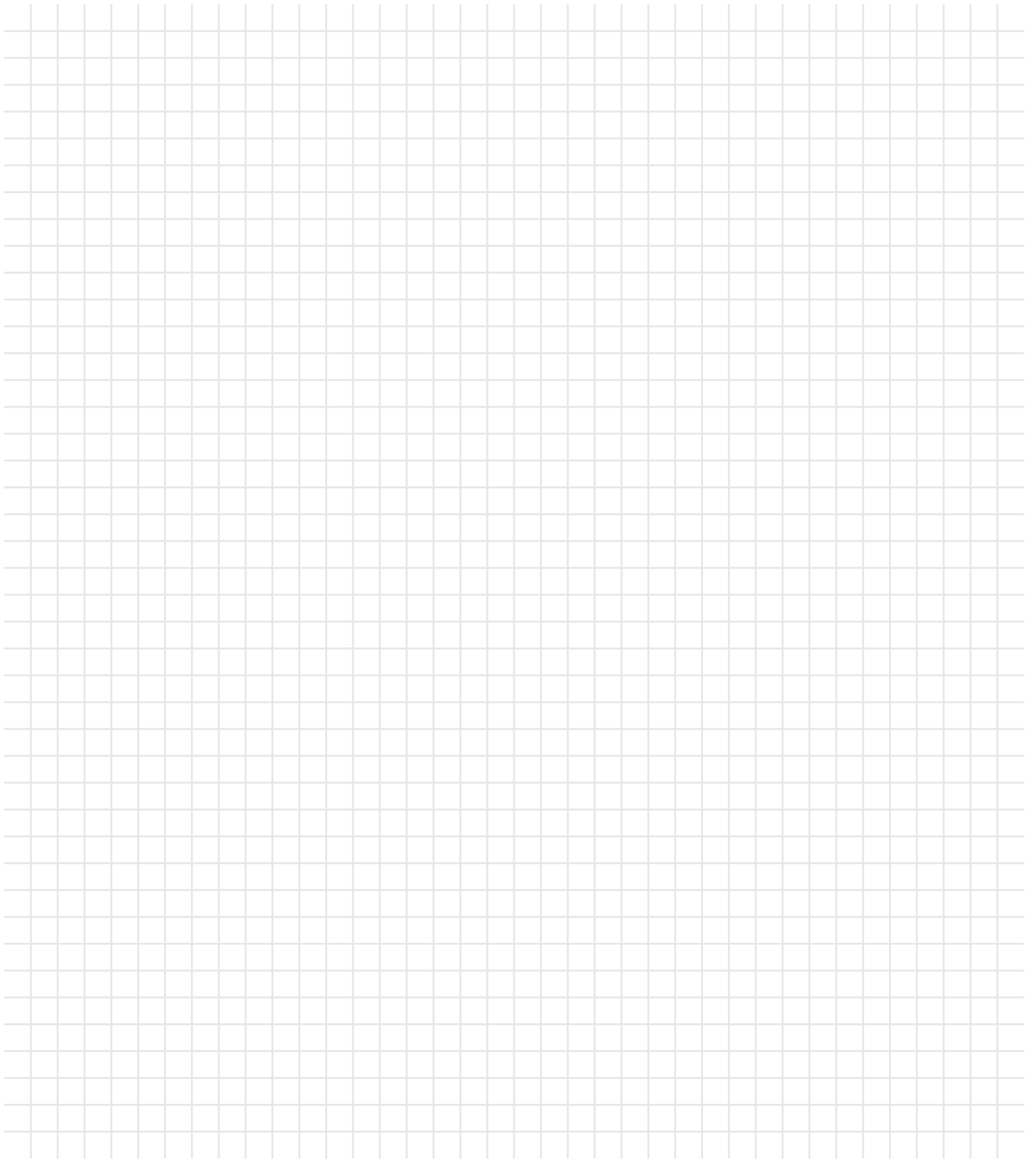

All previous catalogues and price lists are no longer valid with the issue of this catalogue. Errors, misprints, model and price changes and technical modifications are reserved. We deliver based on our terms of delivery and payment. Our products comply with the European light norm EN60598. Products with the ENEC test mark are conforming to the guide line 2006/95/EG. Products with additional safety remarks (e.g protection class, IP) are identified within the product family with the relevant symbol and number. The content of this catalogue is protected under copyright law for EGLO Leuchten GmbH. All rights reserved. Our specific written consent must be obtained before using any illustrations and texts. The pictures are 4C prints and may differ from the original.

The product pictures and ambiances in this catalogue can deviate from reality, and they do not necessarily concur with the usual application of the product. EGLO does not assume liability for the correctness, completeness or the application depiction of the products and/or the product information.

Design, layout and composition: EGLO GmbH, A-6136 Pill - AUSTRIA
Print: Johann Sandler GesmbH & Co KG, 3671 Marbach
Pictures: EGLO, fotolia.com, istockphoto.com

Mit diesem Katalog verlieren alle vorhergehenden Kataloge und Preislisten ihre Gültigkeit. Irrtümer, Druckfehler, Modell- und Preisänderungen sowie technische Änderungen vorbehalten. Wir liefern zu unseren Liefer- und Zahlungsbedingungen. Unsere Produkte entsprechen der europäischen Leuchtnorm EN 60598. Produkte mit dem ENEC Prüfzeichen sind konform mit der Richtlinie 2006/95/EG. Produkte mit weiteren Sicherheitshinweisen (zB. Schutzklasse, IP) sind mit Symbol und Zahl bei der Produktfamilie ausgezeichnet. Der Inhalt dieses Kataloges ist für die EGLO Leuchten GmbH urheberrechtlich geschützt. Alle Rechte sind vorbehalten. Bilder und Texte dürfen nicht ohne vorherige ausdrückliche, schriftliche Genehmigung verwendet werden. Die Abbildungen sind 4C Drucke und können vom Original abweichen.

Die Katalogbilder und die gezeigten Darstellungen der Produkte können von der Wirklichkeit abweichen und nicht den üblichen Produktanwendungen entsprechen. EGLO übernimmt keine Haftung für die Richtigkeit, Vollständigkeit und Anwendungsdarstellung der Produkte und Produktinformationen.

Gestaltung, Layout und Satz: EGLO GmbH, A-6136 Pill - AUSTRIA
Druck: Johann Sandler GesmbH & Co KG, 3671 Marbach
Bilder: EGLO, fotolia.com, istockphoto.com

Le présent catalogue remplace tous les catalogues et tarifs précédents. Sous réserve d'erreurs, de fautes d'impression, de modification des modèles et de changement de prix et de technique. Nous livrons sur la base de nos conditions de livraison et de paiement. Nos produits sont conformes aux normes européennes EN 60598 et portent le marquage CE. Les produits portant la marque ENEC sont conformes à la Directive 2006/95/EG. Les produits portant d'autres indications de sécurité (par exemple classe de protection, IP) sont identifiés par le symbole et le nombre correspondants dans la famille de produits.

Le contenu du présent catalogue est protégé pour la société EGLO Leuchten GmbH par un copyright. Tous droits réservés. Toute reproduction d'images et de texte est interdite sans autorisation explicite par écrit préalable. Les images sont imprimées en 4C et peuvent différer de l'original.

Les images des produits et les ambiances dans le catalogue peuvent dévier de la réalité et ne sont pas nécessairement en ligne avec l'usage habituel du produit. EGLO n'engage pas sa responsabilité sur la justesse des images et sur les informations relatives à l'usage pouvant être fait des produits.

Conception, maquette et composition: EGLO GmbH, A-6136 Pill - AUSTRIA
Presse: Johann Sandler GesmbH & Co KG, 3671 Marbach
Images: EGLO, fotolia.com, istockphoto.com

12-2018



EGLO
my light | my style

EGLO Leuchten GmbH
Heiligkreuz 22
A-6136 Pill
Austria
Tel. +43 (0) 5242 6996
Fax +43 (0) 5242 6996-972
info@eglo.com
www.eglo.com

KATA 19



www.eglo.com

my light | my style